



POL-SKONE®
DOORS AND WINDOWS

naturally!



BESTSELLER
2026

Valid from 01.02.2026



BESTSELLER 2026



TABLE OF CONTENTS

SEDO - NEW VERSION	6
VERI - NEW VERSION	8
MODO	10
EGRO	12
ESTO	14
ARCO	16
UNITO	18
SAMOS	20
FORTO - NEW VERSION	22
MAGRO	24
LAURA - NEW	26
REBATED DOOR FRAMES	28
NON-REBATED DOOR FRAMES	29
COLOR RANGE	30

DOOR SYSTEMS AND OPENING DIRECTIONS



REBATED SYSTEM

The door leaf has a rebate (notch, groove) that overlaps the door frame

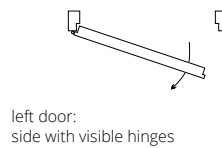

left door:
side with visible hinges

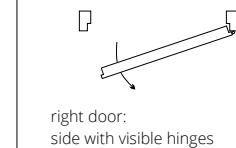

right door:
side with visible hinges



NON-REBATED SYSTEM

The straight edge of the door leaf creates a uniform surface with the door frame

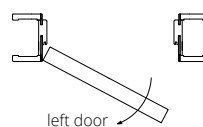

left door

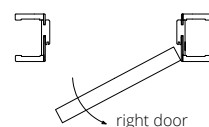

right door



REVES SYSTEM

The door leaf has a reverse rebate (notch, groove) that creates a uniform surface with the door frame

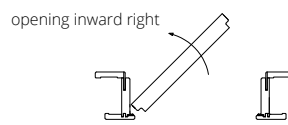

opening inward right

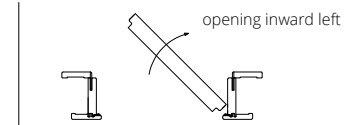

opening inward left

HOW TO PRICE THE DOOR

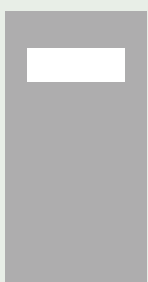

CHOOSE THE DOOR LEAF



CHOOSE THE DOOR FRAME

hinges are already included in the price



CHOOSE THE HANDLE



handle price



NON-STANDARD ELEMENTS

accessories price, additional equipment



PRICE OF COMPLETE DOORS

BESTSELLER 2026

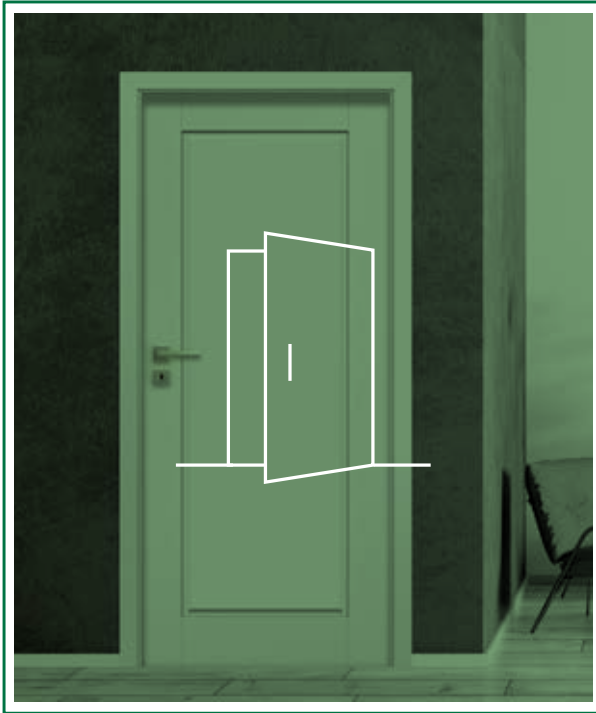

CLASSIC AND MODERN DOOR DESIGN

The **BESTSELLER** collection combines the most important aspects of interior design – timeless elegance and fresh, contemporary accents. The doors have been designed to harmoniously complement both traditional and minimalist spaces. Diverse stylistic models, precise lines, carefully crafted panels, and a wide range of veneers and color range allow for the creation of a cohesive and aesthetic arrangement in any room. This is the ideal choice for those seeking doors with a universal character – elegant, yet perfectly in line with the latest design versions.



EXCELLENT WORKMANSHIP

with standard protection of the lower edge of the door leafs using a special impregnating agent against moisture.

Doors from the **BESTSELLER** collection are distinguished by exceptional durability, resulting from both the selection of high-quality materials and meticulous production technology. Each door leaf is factory-protected on the lower edge with a special impregnating agent of increased moisture resistance. This solution protects the structure of the door against deformation, swelling, and damage caused by contact with water, extending their lifespan even in intensively used rooms such as kitchens or bathrooms. Thanks to this, users receive a product that is not only aesthetic, but also solid, stable, and designed for long-term comfort.

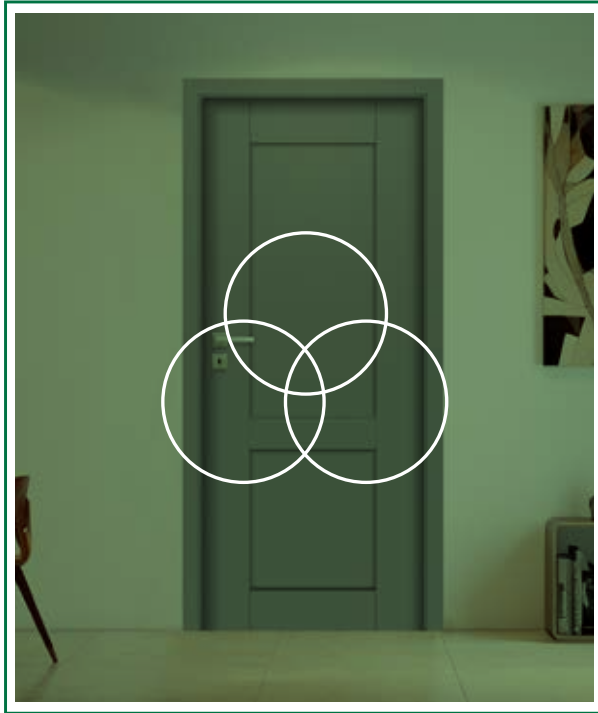

TIMELESS COLOR RANGE

The **BESTSELLER** collection was designed with harmony and universality in mind, which is why it offers a color palette that does not follow temporary trends. These are carefully selected shades inspired by natural wood, subdued elegance, and subtle modernity. Timeless color range works perfectly in classic interiors, but is equally impressive in loft, minimalist, or Scandinavian arrangements. Thanks to such a wide range of finishes, **BESTSELLER** doors are easy to match to any style and character of space, creating a cohesive and aesthetic environment.

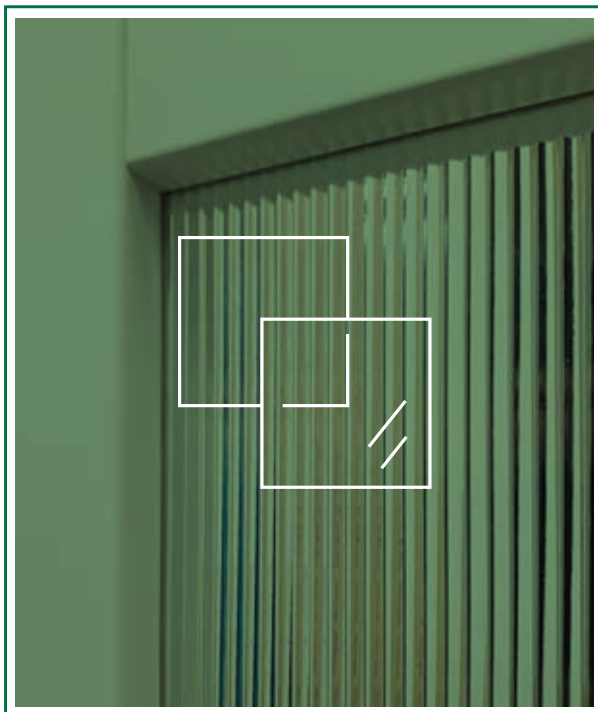

MANY TYPES OF GLASS IN VARIOUS COLORS AND STRUCTURES

Doors from the **BESTSELLER** line allow for a wide range of personalization thanks to a rich selection of glazing options. Various types of glass are available – from classic matt and transparent to impressive structural glass. Each variant can be color-matched to the selected door model and interior arrangement, achieving the perfect balance between aesthetics and functionality. Antisol grey and dark grey are satin, semi-transparent glass types with low reflectivity, giving the door a decorative effect. LINEA (transparent) and MORU (deep brown shade) glass are fluted, elegant ornamental glass types that are currently dominant in interior design projects. The glass used is characterized by high quality and user safety, and the varied structures and colors allow for both a subtle diffused light effect and more pronounced decorative accents.



W00 / V01



W01S8 / V1S8



W01S8 black muntins



W01 / V1SD



W02 / V02



W03 / V03



W04 / V04



W01 | WLA/Z

mirror*

**NEW
VERSION**

* WLZ - mirror on the hinge side
WLA/Z - mirror on the side opposite to the hinge



SEDO door, version W03, adjustable DIN door frame



muntin profile



LINEA tempered glass

COLOR RANGE – p. 30-31

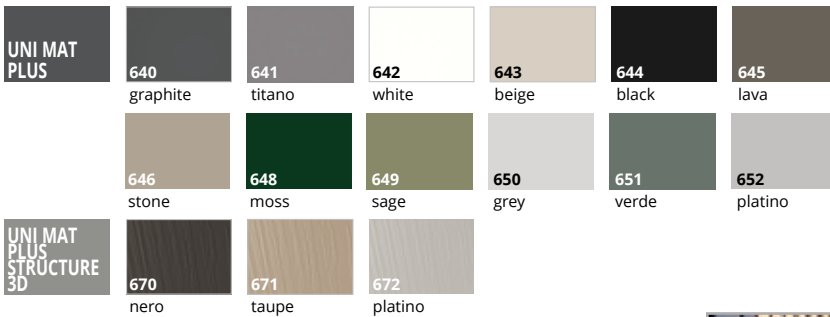

beveling of the edges at the stile and rail joints



MORU glass



mirror (applies to versions WLZ, WLA/Z)

STANDARD EQUIPMENT

stile and rails with a thickness of 40 mm, muntins in the color of the door leaf or black

version W00, W02, W03, W04: panel with a thickness of 12 mm

version W01, W01S8: clear tempered glass or white matt with a thickness of 4 mm
it is not possible to use laminated glass VSG 22.1, VSG 33.1



hinge visible, silver galvanized - 3 pcs.
lock latch-bolt, silver:
for key, cylinder, bathroom lock, without keyhole



concealed hinge, satin nickel - 3 pcs.
magnetic lock, satin chrome:
for key, cylinder, bathroom lock, without keyhole

FOR EXTRA CHARGE

LINEA clear glass with a thickness of 4 mm, single-sided ornament

MORU tempered glass with a thickness of 4 mm

drop seal

heat recovery ventilation (applies to doors of standard height)

ventilation undercut

door frames (rebated system, non-rebated system)

p. 28-29



change of lock color to black



change of hinge color to white or black (pc.)
change of hinge color to gold (pc.)
change of magnetic lock color to white, black or gold
non-rebated lock with latch (silver, white, black or gold) - NEW

Height	- 50 mm	+ 50 mm	+ 100 mm	+ 150 mm	+ 200 mm
up to 5 pcs.	without extra charge	+15%	+15%	+25%	+25%
over 5 pcs.	without extra charge	+10%	+10%	+20%	+20%

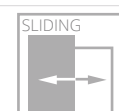

VERI



W00 / V01



W01 / V1SD



V1SP



W02 / V02



W03 / V03



W04 / V04



VERI door, version W00, adjustable DIN DUO door frame



frame profile



bevel at the stile and rail joints

COLOR RANGE – p. 30-31

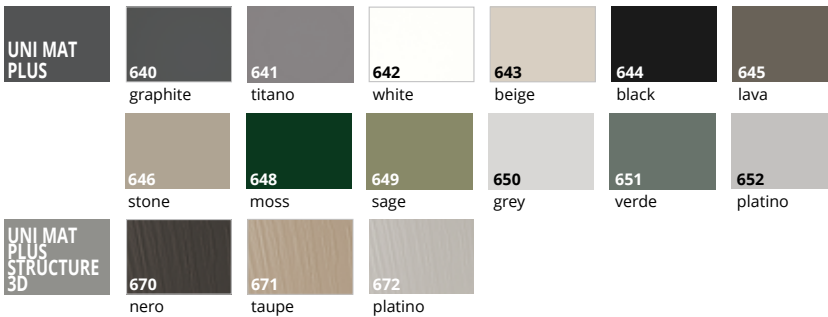



panel with finished edge glued to the glass – version V1SP



decorative overlay (option)

STANDARD EQUIPMENT					
stile and rails with thickness of 40 mm					
panel with thickness of 12 mm					
white matt glass with thickness of 4 mm					

rebated SYSTEM	
	hinge visible, silver galvanized - 3 pcs. lock latch-bolt, silver: for key, cylinder, bathroom lock, without keyhole

non-rebated SYSTEM	
	concealed hinge, satin nickel - 3 pcs. magnetic lock, satin chrome: for key, cylinder, bathroom lock, without keyhole



Height	- 50 mm	+ 50 mm	+ 100 mm	+ 150 mm	+ 200 mm
up to 5 pcs.	without extra charge	+15%	+15%	+25%	+25%
over 5 pcs.	without extra charge	+10%	+10%	+20%	+20%

FOR EXTRA CHARGE	
tempered transparent glass with thickness of 4 mm	
tempered Antisol grey glass (version V1SP)	
tempered Antisol dark grey, brown glass (version V1SP)	
VSG 22.1 laminated glass in black color (version W01, V1SP)	
VSG 22.1 laminated glass in white color (version W01, V1SP)	
drop seal	
heat recovery ventilation (applies to doors of standard height)	
door frames (rebated system, non-rebated system)	

p. 28-29

rebated SYSTEM	
	change of lock color to black

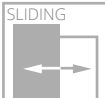
non-rebated SYSTEM	
	change of hinge color to white or black (pc.) change of hinge color to gold (pc.) change of magnetic lock color to white, black or gold non-rebated lock with latch (silver, white, black or gold) - NEW

			
---	--	---	---



W00 / V01



W01 / V1SD



V1SP



W02 / V02



W03 / V03



W04 / V04

INTERIOR DOORS | STILE AND RAIL TYPE | LAMINATED



MODO door, version W00, adjustable DIN door frame



frame profile



panel with finished edge glued to the glass – version V1SP





decorative overlay (option)



COLOR RANGE – p. 30-31

UNI MAT PLUS	640 graphite	641 titano	642 white	643 beige	644 black	645 lava
	646 stone	648 moss	649 sage	650 grey	651 verde	652 platino
UNI MAT PLUS STRUCTURE 3D	670 nero	671 taupe	672 platino			

STANDARD EQUIPMENT	
stile and rails with thickness of 40 mm	
panel with thickness of 12 mm	
spatial decorative frame	
white matt tempered glass with thickness of 4 mm (version W01)	

FOR EXTRA CHARGE	
tempered transparent glass with thickness of 4 mm	
tempered Antisol grey glass (version V1SP)	
tempered Antisol dark grey, brown glass (version V1SP)	
VSG 22.1 laminated glass in black color (version W01, V1SP)	
VSG 22.1 laminated glass in white color (version W01, V1SP)	
drop seal	
heat recovery ventilation (applies to doors of standard height)	
ventilation undercut	
door frames (rebated system, non-rebated system)	p. 28-29

	hinge visible, silver galvanized - 3 pcs. lock latch-bolt, silver: for key, cylinder, bathroom lock, without keyhole
	concealed hinge, satin nickel - 3 pcs. magnetic lock, satin chrome: for key, cylinder, bathroom lock, without keyhole

	change of lock color to black
	change of hinge color to white or black (pc.) change of hinge color to gold (pc.) change of magnetic lock color to white, black or gold non-rebated lock with latch (silver, white, black or gold) - NEW

Height	- 50 mm	+ 50 mm	+ 100 mm	+ 150 mm	+ 200 mm
up to 5 pcs.	without extra charge	+15%	+15%	+25%	+25%
over 5 pcs.	without extra charge	+10%	+10%	+20%	+20%

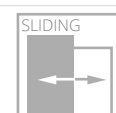



W00 / V01



W01 / V1SD



W02 / V02



W03 / V2SD



W04 / V03



W05 / V3SD



EGRO door, version W00, adjustable DIN DUO door frame



spatial panel



LINEA tempered glass





vertical stile and rail joint with horizontal

COLOR RANGE – p. 30-31

UNI MAT PLUS	640 graphite	641 titano	642 white	643 beige	644 black	645 lava
	646 stone	648 moss	649 sage	650 grey	651 verde	652 platino
UNI MAT PLUS STRUCTURE 3D	670 nero	671 taupe	672 platino			

STANDARD EQUIPMENT	
stile and rails with thickness of 40 mm	
spatial panel with thickness of 16 mm	
white matt tempered glass with thickness of 4 mm	

	hinge visible, silver galvanized - 3 pcs. lock latch-bolt, silver: for key, cylinder, bathroom lock, without keyhole
--	--

	concealed hinge, satin nickel - 3 pcs. magnetic lock, satin chrome: for key, cylinder, bathroom lock, without keyhole
--	---

Height	- 50 mm	+ 50 mm	+ 100 mm	+ 150 mm	+ 200 mm
up to 5 pcs.	without extra charge	+15%	+15%	+25%	+25%
over 5 pcs.	without extra charge	+10%	+10%	+20%	+20%

FOR EXTRA CHARGE	
tempered transparent glass with thickness of 4 mm	
LINEA tempered transparent glass with thickness of 4 mm, single-sided ornament	
MORU tempered glass with a thickness of 4 mm	
drop seal	
heat recovery ventilation (applies to doors of standard height)	
ventilation undercut	
door frames (rebat system, non-rebat system)	p. 28-29

	change of lock color to black
---	-------------------------------

	change of hinge color to white or black (pc.) change of hinge color to gold (pc.) change of magnetic lock color to white, black or gold non-rebat lock with latch (silver, white, black or gold) - NEW
---	--

			
---	--	---	---



V03



V3S1



V3S2



V3S3



V3S4



V3S5



ESTO door, version V3S5, adjustable DIN door frame

COLOR RANGE – p. 30-31

LAMISTONE CPL	213 super white	231 Halif oak	250 terra oak	289 grey
	230 gran oak	276 Polish oak	NEW 290 Royal oak	
	640 graphite	641 titano	642 white	643 beige
				645 lava
			646 stone	

STANDARD EQUIPMENT

- vertical stile and rails with a thickness of 40 mm and horizontal stile and rails with a thickness of 35 mm
- panels with a thickness of 22 mm
- white matt glass with a thickness of 4 mm

rebated SYSTEM
hinge visible, silver galvanized - 3 pcs.
lock latch-bolt, silver:
for key, cylinder, bathroom lock, without keyhole

non-rebated SYSTEM
concealed hinge, satin nickel - 3 pcs.
magnetic lock, satin chrome:
for key, cylinder, bathroom lock, without keyhole

FOR EXTRA CHARGE

- tempered transparent glass with thickness of 4 mm
- laminated glass VSG 22.1 black color (applies to 1 pane)
- drop seal
- heat recovery ventilation (applies to doors of standard height)
- ventilation undercut
- door frames (rebated system, non-rebated system) p. 28-29

rebated SYSTEM
change of lock color to black

non-rebated SYSTEM
change of hinge color to white or black (pc.)
change of hinge color to gold (pc.)
change of magnetic lock color to white, black or gold
non-rebated lock with latch (silver, white, black or gold) - **NEW**

Height	- 50 mm	+ 50 mm	+ 100 mm	+ 150 mm	+ 200 mm
without extra charge	-	-	-	-	-





W02P / V02



W2S / V2S2



W02 / V2S5



W2D / V1SD



W03P / V03



W3S / V3S2



W03 / V3S5



ARCO door, version W03P, adjustable DIN door frame



stile and rail vertical grain, panels and infill horizontal



panels, glazing



for extra charge: **laminated glass VSG 22.1 in black color**

COLOR RANGE – p. 30-31



STANDARD EQUIPMENT

vertical stile and rails with a thickness of 40 mm and horizontal stile and rails with a thickness of 35 mm

glass: white matt, brown matt or transparent, 4 mm thick
tempered white matt glass, 4 mm thick (version W2D)



hinge visible, silver galvanized - 3 pcs.
lock latch-bolt, silver:
for key, cylinder, bathroom lock, without keyhole



concealed hinge, satin nickel - 3 pcs.
magnetic lock, satin chrome:
for key, cylinder, bathroom lock, without keyhole

FOR EXTRA CHARGE

tempered transparent glass with thickness of 4 mm
laminated glass VSG 22.1 white, black or transparent

(applies to 1 pane) - version W02

laminated glass VSG 22.1 white, black or transparent

(applies to 1 pane) - version W03

drop seal

heat recovery ventilation (applies to doors of standard height)

ventilation undercut

door frames (rebated system, non-rebated system)

p. 28-29



change of lock color to black



change of hinge color to white or black (pc.)
change of hinge color to gold (pc.)
change of magnetic lock color to white, black or gold
non-rebated lock with latch (silver, white, black or gold) - **NEW**

Height	- 50 mm	+ 50 mm	+ 100 mm	+ 150 mm	+ 200 mm
	without extra charge	-	-	-	-

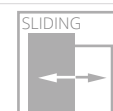

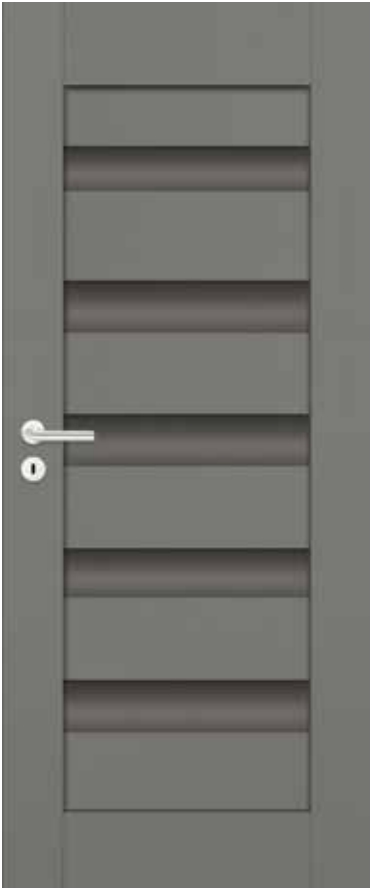

W02P / V02



W2S / V2S2



W02 / V2S5



W03P / V03



W3S / V3S2



W03 / V3S5

INTERIOR DOORS | STILE AND RAIL TYPE | LAMINATED



UNITO door, version W02, adjustable DIN door frame



stile and rail



panels, glazing



for extra charge: laminated glass VSG 22.1 in black color



beveling of the edges at the stile and rail joints

COLOR RANGE – p. 30-31

UNI MAT PLUS	640 graphite	641 titano	642 white	643 beige	644 black	645 lava
	646 stone	648 moss	649 sage	650 grey	651 verde	652 platino
UNI MAT PLUS STRUCTURE 3D	670 nero	671 taupe	672 platino			

STANDARD EQUIPMENT

- stile and rails with thickness of 40 mm
- panels with a thickness of 16 mm
- glass white matt or brown matt with a thickness of 4 mm (versions V2S2, V2S5, V3S2, V3S5)
- infill panel with a thickness of 4 mm in the color of the door leaf with UNI MAT PLUS surface (version V02)

rebated SYSTEM
 hinge visible, silver galvanized - 3 pcs.
 lock latch-bolt, silver:
 for key, cylinder, bathroom lock, without keyhole

non-rebated SYSTEM
 concealed hinge, satin nickel - 3 pcs.
 magnetic lock, satin chrome:
 for key, cylinder, bathroom lock, without keyhole

FOR EXTRA CHARGE

- laminated glass VSG 22.1 black (applies to 1 pane) - version V2S5
- laminated glass VSG 22.1 black (applies to 1 pane) - version V3S5
- drop seal
- heat recovery ventilation (applies to doors of standard height)
- ventilation undercut
- door frames (rebated system, non-rebated system) p. 28-29

rebated SYSTEM
 change of lock color to black

non-rebated SYSTEM
 change of hinge color to white or black (pc.)
 change of hinge color to gold (pc.)
 change of magnetic lock color to white, black or gold
 non-rebated lock with latch (silver, white, black or gold) - **NEW**

Height	- 50 mm	+ 50 mm	+ 100 mm	+ 150 mm	+ 200 mm
without extra charge		-	-	-	-

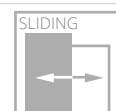

SAMOS



V01

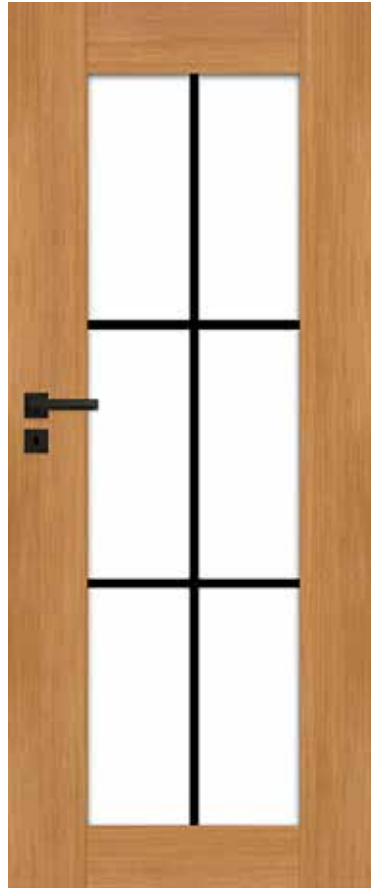

V156



V158



V151



V155



V153

INTERIOR DOORS STILE AND RAIL TYPE LAMINATED



SAMOS door, version V1S5, adjustable DIN door frame



LINEA tempered glass



beveling of the edges at the stile and rail joints

COLOR RANGE – p. 30-31

LAMISTONE CPL			
	233 Salinas oak	234 natural oak	250 terra oak
	SILKSTONE		
230 gran oak		276 Polish oak	NEW 290 Royal oak

STANDARD EQUIPMENT

stile and rails with a thickness of 40 mm, muntins in the color of the door leaf or black
 versions V1S6, V1S8, V1S1, V1S5, V1S3 tempered white matt or transparent glass with a thickness of 4 mm, no possibility to use laminated glass VSG 22.1 and VSG 33.1

rebated SYSTEM
 hinge visible, silver galvanized - 3 pcs.
 lock latch-bolt, silver:
 for key, cylinder, bathroom lock, without keyhole

non-rebated SYSTEM
 concealed hinge, satin nickel - 3 pcs.
 magnetic lock, satin chrome:
 for key, cylinder, bathroom lock, without keyhole

FOR EXTRA CHARGE

LINEA clear glass with a thickness of 4 mm, single-sided ornament
 MORU tempered glass with a thickness of 4 mm
 drop seal
 heat recovery ventilation (applies to doors of standard height)
 ventilation undercut
 door frames (rebated system, non-rebated system) p. 28-29

rebated SYSTEM
 change of lock color to black

non-rebated SYSTEM
 change of hinge color to white or black (pc.)
 change of hinge color to gold (pc.)
 change of magnetic lock color to white, black or gold
 non-rebated lock with latch (silver, white, black or gold) - **NEW**

Height	- 50 mm	+ 50 mm	+ 100 mm	+ 150 mm	+ 200 mm
up to 5 pcs.	without extra charge	+25%	+10%	+25%	+20%
over 5 pcs.	without extra charge	+20%	+10%	+20%	+20%

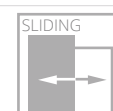

FORTO



V00



V01



V1S



V2S

INTERIOR DOORS | STILE AND RAIL TYPE | LAMINATED



FORTO door, version V1S, adjustable DIN SYSTEM door frame



glazing



protection of the bottom stile and rail using the HOT FOIL method

COLOR RANGE – p. 30-31

LAMISTONE CPL	 231 Halif oak	 233 Salinas oak	 250 terra oak	 263 premium walnut		
	 230 gran oak	 276 Polish oak	 290 Royal oak	NEW		
	 640 graphite	 641 titano	 642 white	 643 beige	 644 black	 645 lava
	 646 stone	 648 moss	 649 sage	 650 grey	 651 verde	 652 platino

STANDARD EQUIPMENT
 vertical stile and rails with a thickness of 40 mm, horizontal with a thickness of 35 mm
 panel with a thickness of 16 mm
 panel insert with a thickness of 4 mm
 VSG 22.1 laminated glass with a thickness of 4 mm in white or black color

rebated SYSTEM
 hinge visible, silver galvanized - 3 pcs.
 lock latch-bolt, silver:
 for key, cylinder, bathroom lock, without keyhole

non-rebated SYSTEM
 concealed hinge, satin nickel - 3 pcs.
 magnetic lock, satin chrome:
 for key, cylinder, bathroom lock, without keyhole

FOR EXTRA CHARGE
 transparent LINEA glass with a thickness of 4 mm (applies to 1 pane)
 drop seal
 heat recovery ventilation (applies to doors of standard height)
 ventilation undercut

door frames (rebated system, non-rebated system) p. 28-29

rebated SYSTEM
 change of lock color to black

non-rebated SYSTEM
 change of hinge color to white or black (pc.)
 change of hinge color to gold (pc.)
 change of magnetic lock color to white, black or gold
 non-rebated lock with latch (silver, white, black or gold) - **NEW**

Height	- 50 mm	+ 50 mm	+ 100 mm	+ 150 mm	+ 200 mm
without extra charge	-	-	-	-	-



MAGRO



V03



V35A



MAGRO door, version V03, adjustable DIN SYSTEM door frame



protection of the bottom stile and rail using the HOT FOIL method

COLOR RANGE – p. 30-31

LAMISTONE CPL						
	250 terra oak	233 Salinas oak				
SILKSTONE			NEW 			
	230 gran oak	276 Polish oak		290 Royal oak		
UNI MAT PLUS						
	640 graphite	641 titano	642 white	643 beige	644 black	645 lava
	646 stone	648 moss	649 sage	650 grey	651 verde	652 platino

STANDARD EQUIPMENT		FOR EXTRA CHARGE	
vertical stile and rails with a thickness of 40 mm, horizontal with a thickness of 35 mm		laminated glass VSG 22.1 black color (applies to 1 pane)	
panel with a thickness of 22 mm		drop seal, heat recovery ventilation	not applicable
panel insert with a thickness of 4 mm		ventilation undercut	
white matt glass, brown matt glass, Antisol dark grey glass with a thickness of 4 mm		door frames (rebated system, non-rebated system)	p. 28-29
hinge visible, silver galvanized - 3 pcs. lock latch-bolt, silver: for key, cylinder, bathroom lock, without keyhole		change of lock color to black	
concealed hinge, satin nickel - 3 pcs. magnetic lock, satin chrome: for key, cylinder, bathroom lock, without keyhole		change of hinge color to white or black (pc.) change of hinge color to gold (pc.) change of magnetic lock color to white, black or gold non-rebated lock with latch (silver, white, black or gold) - NEW	

Height	- 50 mm	+ 50 mm	+ 100 mm	+ 150 mm	+ 200 mm
without extra charge		-	-	-	-

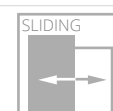

NEW

LAURA



W01 / V01



W02 / V1S1



W03 / V1S2



W04 / V1S3



W05 / V1S4





LAURA door, version W04, adjustable DIN DUO SOLID door frame



connection of stile and rail, panels and glass

COLOR RANGE – p. 30-31

LAMISTONE CPL		213 super white
		276 Polish oak
SILKSTONE		NEW 290 Royal oak

STANDARD EQUIPMENT

stile and rails with thickness of 40 mm
 panel with a thickness of 25 mm
 white matt glass, brown matt glass or transparent glass with a thickness of 4 mm (versions W01-W05)

 hinge visible, silver galvanized - 3 pcs.
 lock latch-bolt, silver:
 for key, cylinder, bathroom lock, without keyhole

 concealed hinge, satin nickel - 3 pcs.
 magnetic lock, satin chrome:
 for key, cylinder, bathroom lock, without keyhole

FOR EXTRA CHARGE

tempered transparent glass with thickness of 4 mm
 ventilation undercut
 door frames (rebated system, non-rebated system) p. 28-29

 change of lock color to black

 change of hinge color to white or black (pc.)
 change of hinge color to gold (pc.)
 change of magnetic lock color to white, black or gold
 non-rebated lock with latch (silver, white, black or gold) - **NEW**

Height	- 50 mm	+ 50 mm	+ 100 mm	+ 150 mm	+ 200 mm
up to 5 pcs.	without extra charge	+20%	+20%	-	-
over 5 pcs.	without extra charge	+15%	+15%	-	-





door frames ADJUSTABLE REBATED

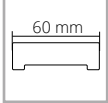
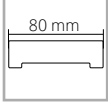
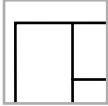
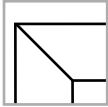

DIN
made of high-quality MDF

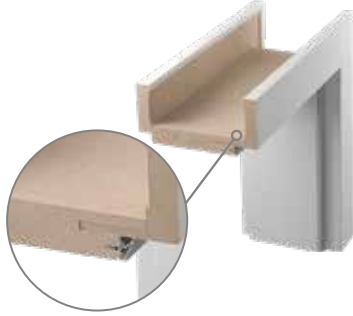

DIN AQUA
made of high-quality MDF,
which is characterized by increased
moisture resistance

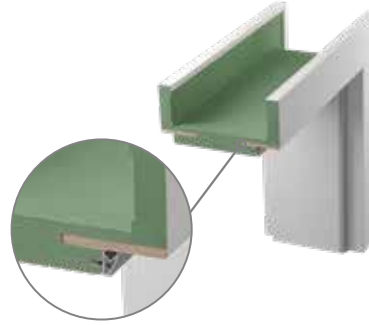

DIN SOLID
made of high-quality laminated wood
(main part), trims made
of high-quality MDF

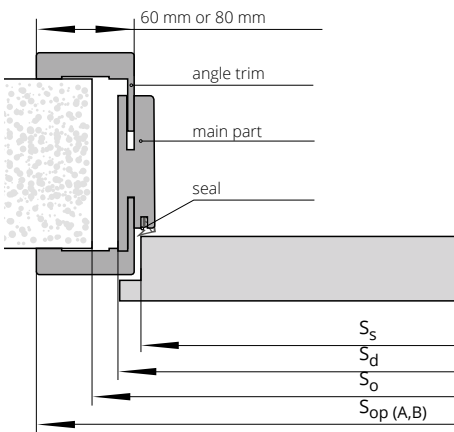

WIDTH										
single-leaf door						double-leaf door				
type	So	Sd	Ss	SopA	SopB	type	So	Sd	SopA	SopB
"60"	676	646	618	748	788	"60"+"60"	1320	1280	1382	1422
"70"	776	746	718	848	888	"60"+"70"	1420	1380	1482	1522
"80"	876	846	818	948	988	"60"+"80","70"+"70"	1520	1480	1582	1622
"90"	976	946	918	1048	1088	"60"+"90","70"+"80"	1620	1580	1682	1722
"90 plus"	986	956	928	1058	1098	"70"+"90","80"+"80"	1720	1680	1782	1822
"100"	1076	1046	1018	1148	1188	"80" + "90"	1820	1780	1882	1922
"110"	1176	1146	1118	1248	1288	"90" + "90"	1920	1880	1982	2022

HEIGHT					
	Ho	Hd	Hs	HopA	HopB
Dimension tolerance ±1mm	2055	2043	2020	2093	2113

So - width of the installation opening
Sd - width of the door on the outside of the door frame
Ss - width of the door leaf
SopA - width of the door frame after "60" trims
SopB - width of the door frame after "80" trims

Ho - height of the installation opening
Hd - height of the door on the outside of the door frame
Hs - height of the door leaf
HopA - height of the door frame after "60" trims
HopB - height of the door frame after "80" trims

EXTRA CHARGES

double-leaf door
width "100"
width "110"

height	- 50 mm	+ 50 mm	+ 100 mm	+ 150 mm	+ 200 mm
	without extra charge	+10%	+10%	+20%	+20%

range [mm]	75-85	85-95	95-120	120-140	140-160	160-180	180-200	200-220	220-240	240-260	260-280	280-300
symbol	ZP1A	ZP1B	ZP2	ZP3	ZP4	ZP5	ZP6	ZP7	ZP8	ZP9	ZP10	ZP11

DIN / DIN AQUA / DIN SOLID

LAMISTONE	SILKSTONE	UNI MAT PLUS
-----------	-----------	--------------

TRIM CONNECTION



version A
connection angle 45°
width 60 mm
without extra charge



version B
connection angle 45°
width 80 mm
without extra charge



version C
connection angle 90°
width 80 mm



version D
connection angle 90°
width 60 mm



door frames

ADJUSTABLE

NON-REBATED

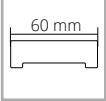
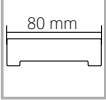
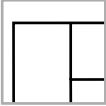

DIN DUO
made of high-quality MDF

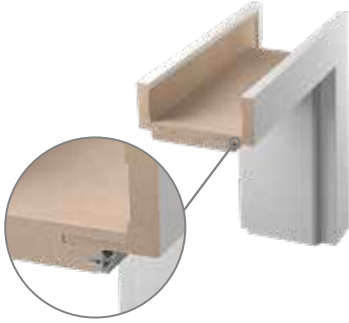

AQUA DIN DUO
made of high-quality MDF,
which is characterized by increased
moisture resistance

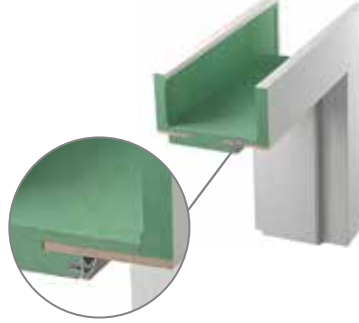

SOLID DIN DUO
made of high-quality laminated wood
(main part), trims made
of high-quality MDF

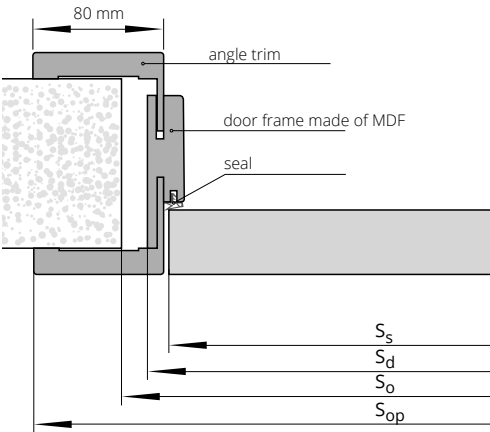

WIDTH									
single-leaf door					double-leaf door				
type	So	Sd	Ss	Sop	type	So	Sd	SopB	
"60"	690	652	625	794	"60"+"60"	1304	1266	1408	
"70"	790	752	725	894	"60"+"70"	1404	1366	1508	
"80"	890	852	825	994	"60"+"80","70"+"70"	1504	1466	1608	
"90"	990	952	925	1094	"60"+"90","70"+"80"	1604	1566	1708	
"90 plus"	1015	977	928	1119	"70"+"90","80"+"80"	1704	1666	1808	
"100"	1090	1052	1018	1194	"80"+"90"	1804	1766	1908	
"110"	1190	1152	1125	1294	"90"+"90"	1904	1866	2008	

HEIGHT				
	Ho	Hd	Hs	HopB
Dimension tolerance ±1mm	2055	2043	2020	2113

So - width of the installation opening
Sd - width of the door on the outside of the door frame
Ss - width of the door leaf
SopA - width of the door frame after "60" trims
SopB - width of the door frame after "80" trims

Ho - height of the installation opening
Hd - height of the door on the outside of the door frame
Hs - height of the door leaf
HopA - height of the door frame after "60" trims
HopB - height of the door frame after "80" trims

EXTRA CHARGES

	height	- 50 mm	+ 50 mm	+ 100 mm	+ 150 mm	+ 200 mm
double-leaf door						
width "100"		without extra charge	+10%	+10%	+20%	+20%
width "110"						

range [mm]	75-85	80-85	85-95	95-120	120-140	140-160	160-180	180-200	200-220	220-240	240-260	260-280	280-300
symbol	ZD1	ZD2	ZD3	ZD4	ZD5	ZD6	ZD7	ZD8	ZD9	ZD10	ZD11	ZD12	ZD13

DIN DUO / DIN DUO AQUA / DIN DUO SOLID

LAMISTONE	SILKSTONE	UNI MAT PLUS
-----------	-----------	--------------

TRIM CONNECTION



version A
connection angle 45°
width 60 mm
without extra charge



version B
connection angle 45°
width 80 mm
without extra charge



version C
connection angle 90°
width 80 mm



version D
connection angle 90°
width 60 mm

COLOR RANGE

UNI MAT PLUS

Reinforced surface characterized by a silky haptic feel and a special coating resistant to fingerprints.



640 graphite



641 titano

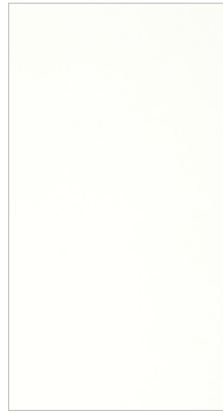

642 white

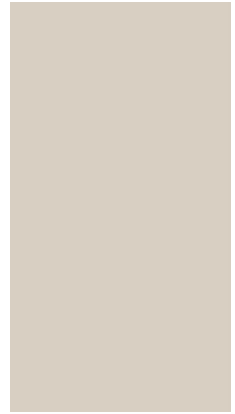

643 beige



644 black

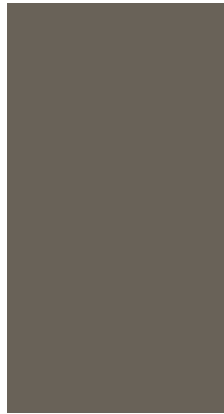

645 lava

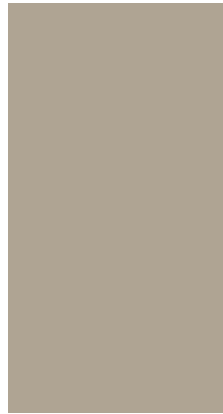

646 stone



648 moss



649 sage

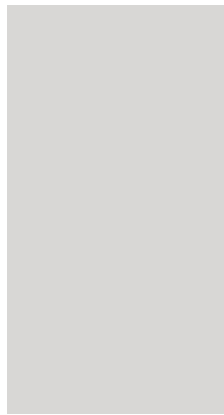

650 grey

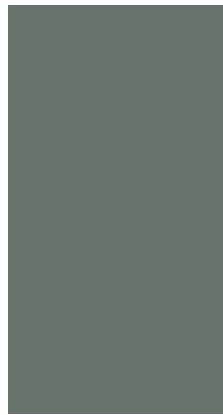

651 verde

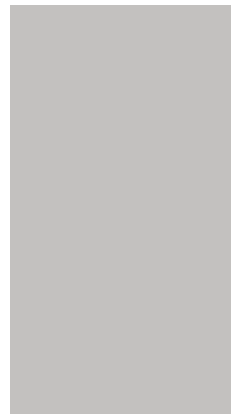

652 platino

UNI MAT PLUS STRUCTURE 3D

Surface with UNI MAT PLUS characteristics with an additional effect of real wood texture.



670 nero



671 taupe



672 platino

LAMISTONE CPL

Surface with a protective coating against abrasion and the effects of chemical agents.



231 halif oak



243 delano oak



250 terra oak



263 premium walnut

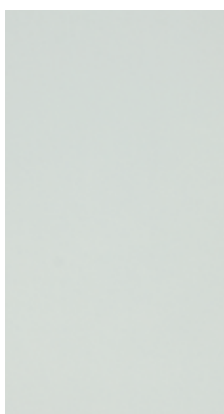

289 grey

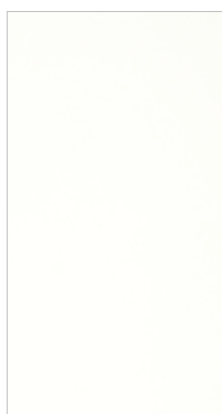

213 super white



233 Salinas oak



234 natural oak

SILKSTONE

Surface with LAMISTONE CPL characteristics, featuring an additional, unique effect of real wood structure.



230 gran oak



276 Polish oak



290 Royal oak



293 Royal anthracite



295 Royal merbau

POL-SKONE Sp. z o.o.

8 Hanki Ordonówny St.; 20-328 Lublin

tel.: +48 81 728 52 00

fax +48 81 744 24 89

pol-skone@pol-skone.eu

EXPORT
DEPARTMENT



DOWNLOAD THE CURRENT CATALOG USING THE QR CODE

CATALOG
OF PRODUCTS



EXTERIOR
WOODWORK



DOOR CATALOG
STEEL



LookBook



/ pol-skone



/ OdkryjLepszeWnetrze



/ pol_skone



pol-skone.pl

This Product Catalog is valid **from 01.02.2026**.

This publication does not constitute an offer within the meaning of the law and is for information purposes only. The manufacturer reserves the right to make changes.