



DRZWI I OKNA

NEW
PRODUCTS
2024

EDITION I/2024

Valid from 10.01.2024

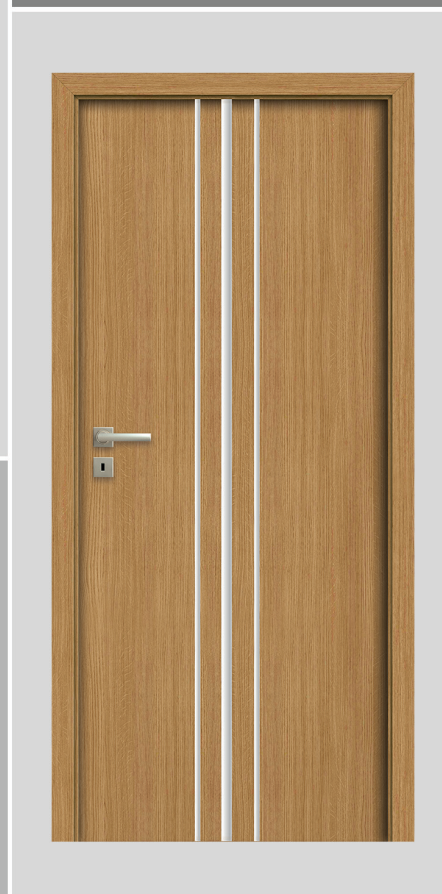
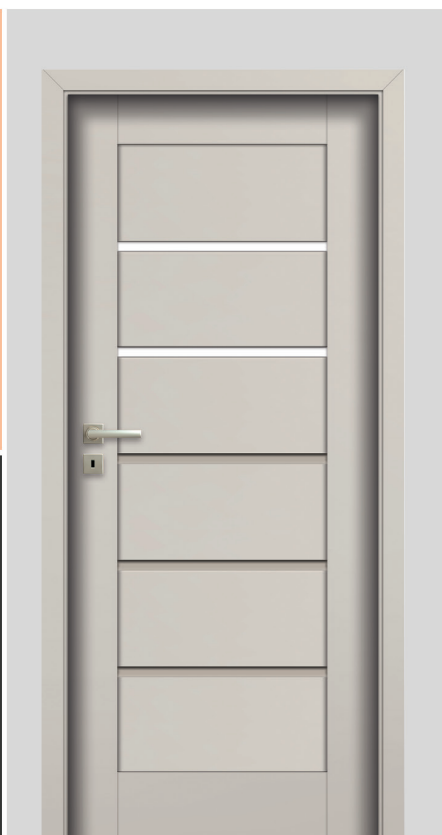

www.pol-skone.eu

NEW ADDITIONS



Special leaf surcharges:

- perforated chipboard filling
- solid chipboard filling



Changing the edge
black rebate system, DUO, Reves (does not apply to ABS edging)

NEW COLOUR OAK NATURE



The colour range of **LAMISTONE** and **CPL laminated** surfaces has been expanded to include the new colour **oak natura**.

The new colour will have the designation::

- **234 (LAMISTONE CPL)** - available in the IMPULS model and in technical doors
- **834, 934, 734 (CPL laminated)** - available in the DECO model and in technical doors

NEW SILKWOOD COLOURS

We would like to inform you that with the ever growing interest in **SILKWOOD** colours, we are extending this colour group with 5 new colours - **matt grey (RAL 7047)**, **grey (RAL 7038)**, **indigo matt (RAL 5011)**, **beige (NCSs2005-Y50R)** and **sage matt (NCS S 4010-G50Y)**



452 matt grey (RAL 7047)

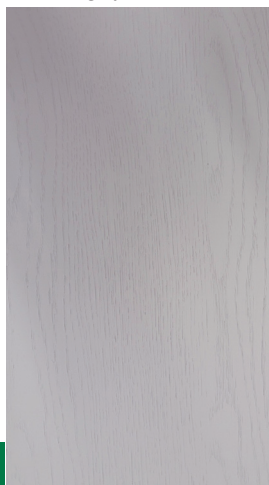

456 grey (RAL 7038)



455 beige (NCSs2005-Y50R)



454 sage mat (NCS S 4010-G50Y)



453 indigo mat (RAL 5011)

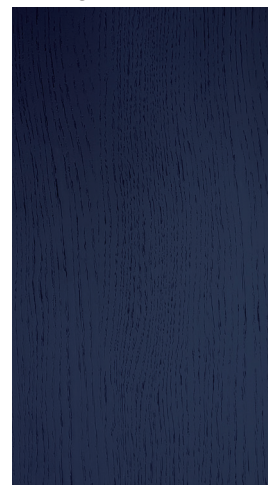

HARMONY NEW MODELS AVAILABLE WITH CONCEALED DOOR SYSTEM



We would like to present the latest extension to the HARMONY concealed door design range, introducing the **ESTATO A01, ESPINA W01, ESTADO LUX A01, CREATO A01, ZENN A01** models.



Applies to standard height models.

As an option, doors can be made 50 mm or 55 mm lower (does not apply to model ZENN).

MODO, VERI, EGRO MODELS AVAILABLE WITH REVERSE REBATE SYSTEM REVES

We would like to inform you that **MODO, VERI, EGRO** door models in all patterns are available also in reverse rebate system **REVES**.



ALWAYS TRENDS DOORS PAINTED IN THE MOST FASHIONABLE COLOURS

As a company that constantly follows the latest trends, we are happy to announce that the colour PANTONE Peach Fuzz, which has been available in our painted door collection since November 2023, has been selected as the colour of the Year 2024. We recommend our painted doors **FIORD, CAMBIO, SIMPLE, SUBITO, SUBLIME, TIARA, ESTATO, PALAZZO, VERTIGO, VILANO, MODERN, MODENA, MODESTO** in the colour NCS s 0530-Y60R.



COLOUR
OF THE YEAR
2024

**PEACH
FUZZ**

INTERSOLID II AVAILABLE IN REBATE-FREE SYSTEM



The **INTERSOLID II** interior door model is also available in a non-rebated system.



REG-GO PACKAGE FOR STABILIZING THE POSITION OF THE HARMONY CONCEALED SASHES

For stabilising the position of Harmony wings in the underlay for wallpaper, plaster, mirror and other Harmony wings.

CONTENTS OF THE PACKAGE

- Stabilisation bar - 2 pcs. - fitted in the sash on the lock and hinge sides
- Construction strip, wooden, 120 mm wide on the lock and hinge side

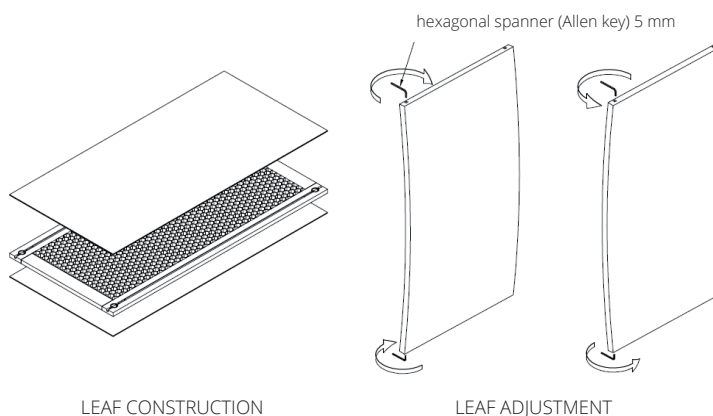

GOLD DECORATION, LOCKS AND HINGES



NONREBATED SYSTEM

- Extra charge for changing the colour of a DUO lock to golden shiny (1 pc.)
- Extra charge for changing the colour of the DUO chrome satin hinge to gold metallic (1 pc.)

HARMONY SYSTEM

- Surcharge for changing the colour of the HARMONY satin chrome hinge to gold (1 pc.)
- Third covered hinge HARMONY in gold (1 pc.)

REVES SYSTEM

- Surcharge for colour change of concealed hinge TE 240 to gold (1 pc.)
- Third covered hinge TE 240 in gold gloss (1 pc.)

REBATE SYSTEM

- Surcharge for changing the colour of the T-type hinge to golden shiny (1 pc.)
- Surcharge for additional Type T hinge in gold gloss (1 pc.)
- Type T third hinge in high-gloss gold (1 pc.)

ALUMINIUM DECORS

- Aluminium decors 10 mm, 25 mm in gold matt (Sonata W9, W10; Maestro) - without surcharge

in the case of a rebate system, we suggest using a black or white lock

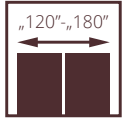
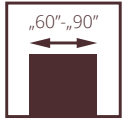

SLIM

**NEW
MODEL**



- **solid construction** made of glued laminated timber frame
- **40 mm** thick vertical glued laminated wood frame
- **35 mm** thick horizontal glued laminated wood frame
- MDF panels 25 mm thick and 260 mm high covered with **UNI MAT PLUS; SILKSTONE** or **LAMISTONE** surface.

SLIM doors, V3SA design, DIN SYSTEM adjustable frame



LAMINATED

FRAMING

INTERIOR DOORS



SLIM doors design V3S5, DIN adjustable frame



VERSION V03 V3S5 V3S1 V3S2 V3S3 V3S4 V3SA

COLOURS



FRAME

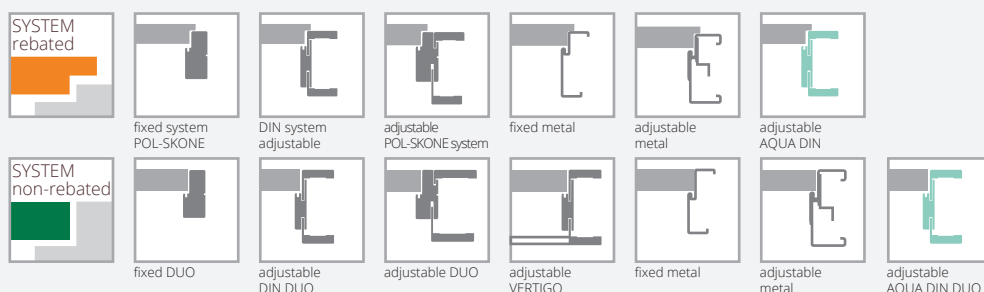

EQUIPMENT

STANDARD	ADDITIONAL
40 mm thick vertical glued laminated timber frames	size „100“
35 mm thick horizontal glued laminated timber frames	doors lower by 50 mm (rebate system)
MDF panels 25 mm thick and 260 mm high	55 mm lower doors (rebate system)
mortise single point locking system, 72 mm thick, with key WK, WB, WC or magnetic mortise lock with key (90 mm thick), insert (85 mm thick) or bathroom lock (WC)	doors higher by 50 mm or 100 mm (third hinge required at extra charge)
hinges: type K nickel brushMDF panels 25 mm thick and 260 mm high ed for DIN door frame, type C nickel brushed - for wooden door frame, type M - for metal door frame or hinge without rebate DUO nickel satin covered hinge („60“-„80“- 2 pcs.; „90“-3 pcs.)	Third hinge in the sash: Type C for widths “60“-“80”. Type K for widths “60“-“80”. type M for widths “60“-“80” covered DUO for widths “60“-“80”
colour 644 black	ventilation undercut
rebate system - silver-coloured hinges; black-coloured lock	recuperative shortcut (only standard heights)
no rebate system - hinges and lock in black	VSG 22.1 laminated glass, black colour (refers to 1 pane)
colour 642 white; super white 213	
rebate system - silver-coloured hinges, white lock	
rebate-free system - hinges and lock in white	
Design V3S1; V3S2; V3S3;V3S4; V3S5; V3SA	
design V03,V3S1;V3S2;V3S3;V3S4; V3SA - panel thickness 4mm in the same colour as the door leaf	
no possibility of using door closer	
no possibility of using a drop seal	

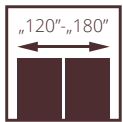
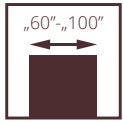

SALEA

**NEW
MODEL**

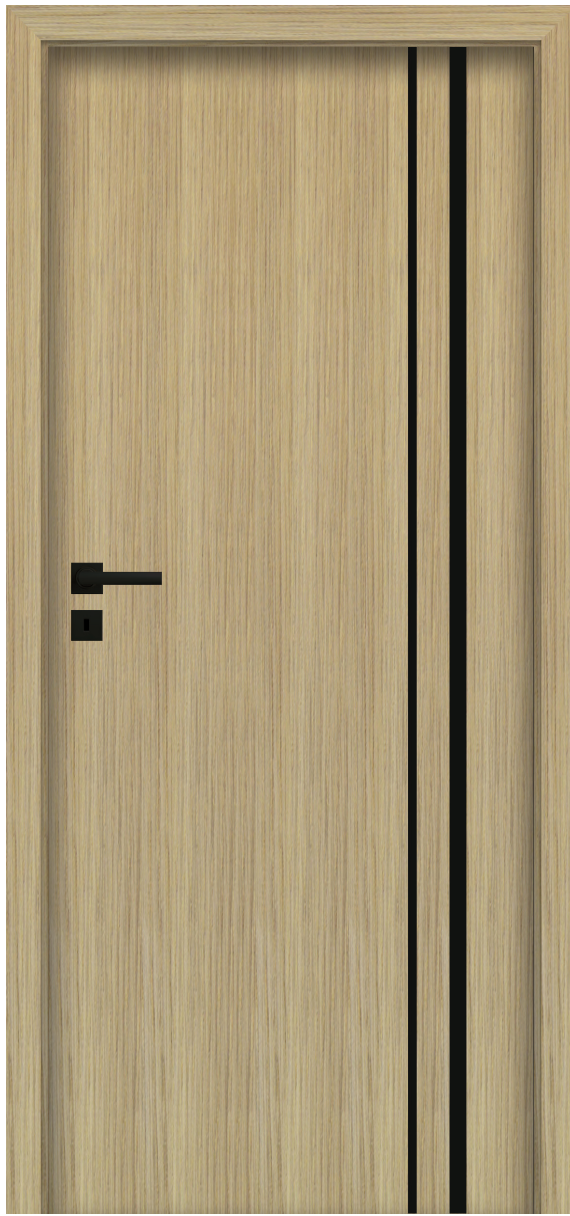

- solid **wooden frame** construction
- surface colours **LAMISTONE CPL, SILKSTONE**
- 25 mm and 10 mm wide ALU decors in **matt black, matt chrome, matt copper and matt gold**



aluminium decors on the leaf surface in copper matt



aluminium decors on the leaf surface in matt black

doors SALEA, model VD10, adjustable frame SYSTEM DIN

INTERIOR DOORS LAMINATED PANELS



doors SALEA design VD9, DIN adjustable frame



VERSION **VD9** **VD10** **VD11**

COLOURS



FRAME

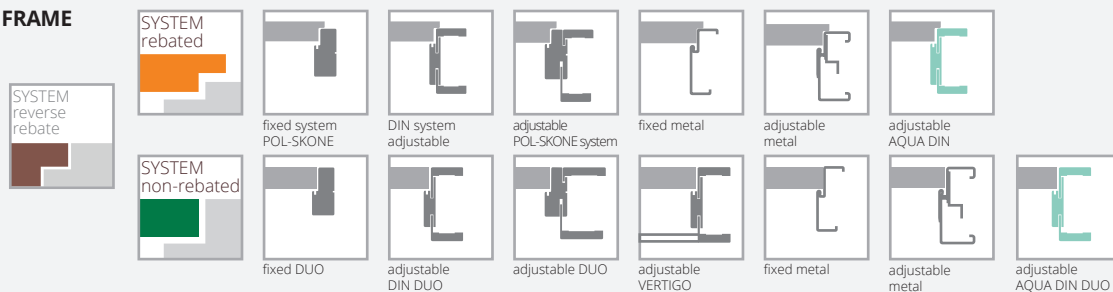

EQUIPMENT

STANDARD

single point locking system, 72 mm spacing (rebate system)
magnetic (rebate system) mortise, keyed (90 mm spacing), cylinder (85 mm spacing) or bathroom lock (90 mm spacing).
(span 90 mm), with insert (span 85 mm) or for bathroom lock (span 90 mm)

hinges: type K - for the DIN door frame, type C - for the wooden door frame, type M - for the metal door frame ("60"- "80" - 2 pcs, "90" - 3 pcs.) or covered DUO satin nickel ("60"- "70" - 2 pcs, "80"- "90" - 3 pcs.)

in case of the sash with the door closer and DIN or metal frame T-type hinges "60"- "80" - 3 pcs. should be used, "90"- "110" - 4 pcs. (exchange of standard hinges for hinges type T hinges for an extra charge)

25 mm and 10 mm wide aluminium decors in chrome matt, black matt, copper matt, gold matt

ADDITIONAL

size „100"

REVES system (reverse rebate)

recuperation shortcut

third hinge in the sash:

Type T for widths "60"- "80".

Type C for widths "60"- "80".

Type K for widths "60"- "80".

Type M for widths "60"- "80".

covered DUO for widths "60"- "70"

reinforcement for the door closer

doors lowered by 50 mm or 100 mm (rebate system)

doors lower by 55 mm or 100 mm (rebate-free system)

door higher by 50 mm or 100 mm (third hinge required at extra charge)

door higher by 150 mm or 200 mm (third hinge required at extra charge)

ventilation undercut

aluminium edging (rebate-free system)

zabezpieczenie dolnego ramiaka przed nadmiernym działaniem wilgoci za pomocą obrzeża ABS (nie dot. skrzydeł z podcięciem wentylacyjnym)

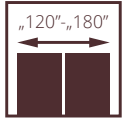
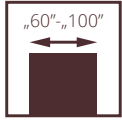

ADORE

**NEW
MODEL**



ADORE doors, style V01, adjustable frame SYSTEM DIN

- solid construction - **wooden frame**
- sturdy hollow board infill
- decorative or flat slats covered with surface **UNI MAT PLUS**
- rich colouring of **UNI MAT PLUS** surface characterised by silky haptics and special coating resistant to fingerprints



design strip

INTERIOR DOORS LAMINATED PANELS



ADORE door style V01, DIN adjustable frame



VERSION V01 V1SD V02 V2SD

COLOURS

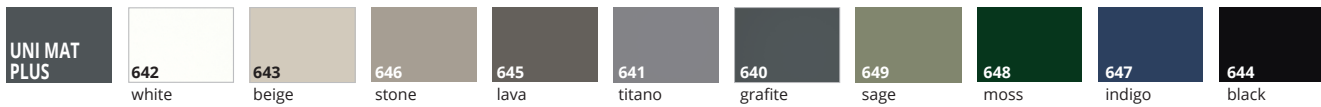

FRAME

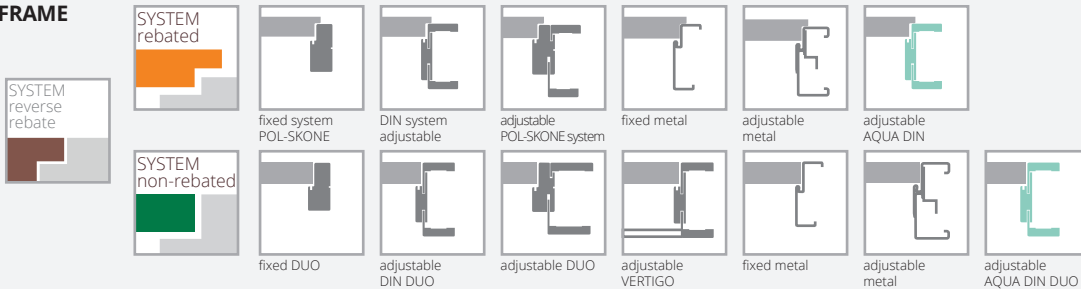

EQUIPMENT

STANDARD	ADDITIONAL
decorative border on a 35 mm wide surface in the colour of the leaf	size „100”
REBATE SYSTEM single point locking system, mortise type, 72 mm spacing, for key (WK), insert (WB) or bathroom lock (WC) silver colour hinges: type T - silver colour (‘‘60”-“80” - 2 pcs., ‘‘90” - 3 pcs.) type C - for wooden door frame	colour change of T type hinge to black colour change of lock to silver, white (rebate-free system)
SYSTEM WITHOUT REBATE magnetic mortise lock, keyed (WK) - (pitch 90 mm), for bathroom lock (WC) - pitch 90 mm; for insert (WB) - pitch 85 mm 85 mm - silver colour covered hinges without rebate - satin nickel colour (‘‘60”-“80” - 2 pcs., ‘‘90” - 3 pcs.)	third hinge in the sash: Type C for widths ‘‘60”-“80” type T for widths ‘‘60”-“80” covered DUO for widths ‘‘60”-“80” exchange of standard hinge DUO in white or black (up to 1 unit) exchange of standard DUO hinge in gold metallic (up to 1 unit)
SYSTEM REVES Magnetic mortise lock (satin chrome), keyed (WK), for bathroom lock (WC) - spacing 90 mm; for insert (WB) - spacing 85 mm covered hinges TE colour satin chrome (‘‘60”-“80” - 2 pcs., ‘‘90”-“100” - 3 pcs.) Due to the design in the leaf from the ZW4 adjustment range, it is possible to open the leaf to a maximum angle of 80 degrees.	exchange of standard lock colour for gold gloss colour change of the TE chrome matt hinge to black (RAL 9005) or white RAL (9016) (up to 1 unit). Surcharge for colour change of concealed hinge TE 240 matt-chrome to gold (1 piece)
HARMONY SYSTEM Due to the design in the leaf from a wall thickness of 135 mm, it is possible to open the leaf to a maximum angle of 80 degrees.	protection of the bottom frame against excessive humidity with ABS edging (does not apply to wings with ventilation cut-out) ventilation undercut

PRINCESTONE

**NEW
MODEL**



- glued laminated timber frame with **decorative profile** at the connection with panel, covered with two smooth, painted HDF boards, thickness 3.5 mm
- spatial panel thickness **22 mm**
- sash painted with a **3-layer paint system** ensuring high durability and resistance of the paint coating



spatial panel thickness
22 mm

PRINCESTONE doors, style V02, adjustable frame SYSTEM DIN

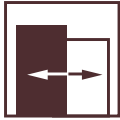
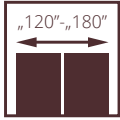
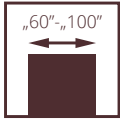

for leaves
with ventilation
option



PRINCESTONE doors, style V05, DIN adjustable frame

PAINTED

FRAMING

INTERIOR DOORS



VERSION **V08** **V05** **V02**

COLOURS

PAINTED	001 white (RAL 9003)	0M5 grey mat (RAL 7047)	0M6 beige mat (NCS S 2005 Y50R)	002 black (RAL 9005)	0M7 sage mat (NCS S 4010-G50Y)
----------------	-----------------------------------	---	---	-----------------------------------	--

FRAME

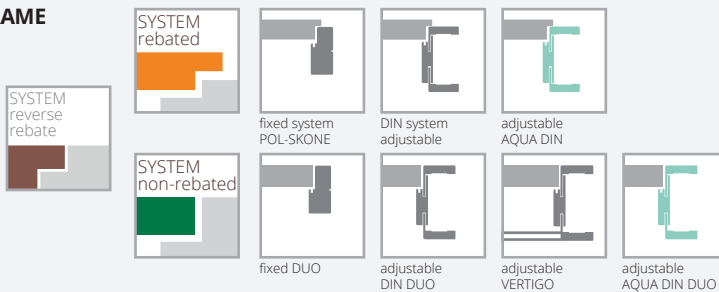

EQUIPMENT

STANDARD	exchange of standard hinge DUO in white or black (up to 1 unit)
REBATE SYSTEM	exchange of standard DUO hinge in gold metallic (up to 1 unit)
single point locking system, 72 mm spacing, mortise type, with key (WK), insert (WB) or bathroom lock (WC)	exchange of standard lock colour for gold gloss
hinges: type K - for DIN-type frame, type C - for wooden frame, type M - for door frame. type M - for metal door frame („60“-„80“ - 2 pieces, „90“ - 3 pieces).	colour change of the TE chrome matt hinge to black (RAL 9005) or white RAL (9016) (up to 1 unit).
SYSTEM WITHOUT REBATE	surcharge for colour change of concealed hinge TE 240 matt-chrome to gold (1 piece)
magnetic mortise lock, keyed (WK) - spacing 90 mm, for bathroom lock (WC) - 90 mm spacing, for insert (WB) - 85 mm spacing.	protection of the bottom frame against excessive humidity with ABS edging (does not apply to wings with ventilation cut-out)
hinge for insert (WB) - spacing of 85 mm	ventilation undercut
covered door hinges („60“-„80“ - 2 pcs., „90“ - 3 pcs.)	door lower by 50 mm (rebate system)
SYSTEM REVES	door lower by 55 mm (rebate-free system)
magnetic mortise lock (satin chrome), keyed (WK), for bathroom lock (WC) - spacing of 90 mm; for insert (WB) - spacing of 85 mm	door higher by 50 mm or 100 mm
TE concealed hinges in satin chrome („60“-„80“ - 2 pcs., „90“ - 3 pcs.)	door higher by 150 mm or 200 mm
ADDITIONAL	
size „100“	
system REVES	
recuperation shortcut	
third hinge in the sash:	
type C for widths „60“-„80“	
type K for widths „60“-„80“	
covered DUO for widths „60“-„80“	

KINGSTONE

**NEW
MODEL**



- glued laminated timber frame with decorative profile at the joint with panel, covered with two 3 mm thick HDF boards covered with natural oak veneer finished with **SILKWOOD** coatings
- spatial panel, 22 mm thick, covered with oak veneer finished with **SILKWOOD** coating



spatial panel thickness
22 mm

KINGSTONE doors, style V08, adjustable frame SYSTEM DIN

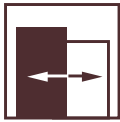
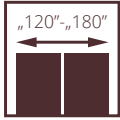
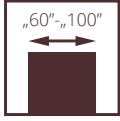

I class
for leaves
with ventilation
option



VENEERED

FRAMING

INTERIOR DOORS



KINGSTONE doors pattern V08, DIN adjustable frame



VERSION V08 V05 V02

COLOURS



FRAME

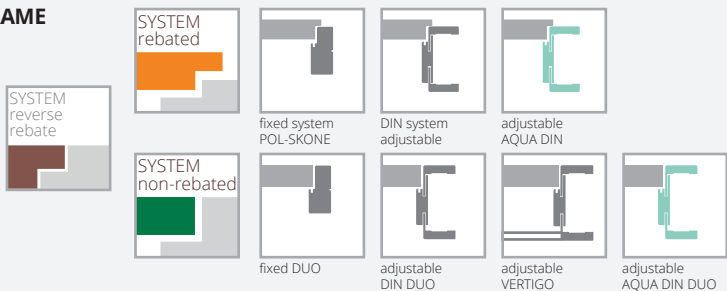

EQUIPMENT

STANDARD
REBATE SYSTEM
 single point locking system, 72 mm spacing, mortise type, with key (WK), insert (WB) or bathroom lock (WC)
 hinges: type K - for DIN-type frame, type C - for wooden frame, type M - for door frame. type M - for metal door frame („60“-„80“ - 2 pieces, „90“ - 3 pieces).
SYSTEM NON-REBATED
 magnetic mortise lock, keyed (WK) - spacing 90 mm, for bathroom lock (WC) - 90 mm spacing, for insert (WB) - 85 mm spacing, hinge for insert (WB) - spacing of 85 mm
 covered door hinges („60“-„80“ - 2 pcs., „90“ - 3 pcs.)
SYSTEM REVES
 magnetic mortise lock (satin chrome), keyed (WK), for bathroom lock (WC) - spacing of 90 mm; for insert (WB) - spacing of 85 mm
 TE concealed hinges in satin chrome („60“-„80“ - 2 pcs., „90“ - 3 pcs.)

ADDITIONAL
 size „100“
 system REVES
 recuperation shortcut
 third hinge in the sash:
 type C for widths „60“-„80“
 type K for widths „60“-„80“
 covered DUO for widths „60“-„80“

exchange of standard hinge DUO in white or black (up to 1 unit)
 exchange of standard DUO hinge in gold metallic (up to 1 unit)
 exchange of standard lock colour for gold gloss
 colour change of the TE chrome matt hinge to black (RAL 9005) or white RAL (9016) (up to 1 unit).
 surcharge for colour change of concealed hinge TE 240 matt-chrome to gold (1 piece)
 protection of the bottom frame against excessive humidity with ABS edging (does not apply to wings with ventilation cut-out)
 ventilation undercut
 door lower by 50 mm (rebate system)
 door lower by 55 mm (non-rebated system)
 door higher by 50 mm or 100 mm (third hinge required) (hinge)
 door higher by 150 mm or 200 mm (third hinge required) (hinge)

SYNTHESIS LINE CASSETTE

Leaf cassette without frame and bands

No wood frame finish or fascia bands

ECLISSE Syntesis Line is a cassette designed for the retractable sliding sash that does not require the use of cover strips. Thanks to this construction, the door panel is discreetly placed in the cassette, resulting in a modern design with the latest technology.



Choosing Syntesis Line cassette

You create a modern room design

The Syntesis Line cassette is designed for minimalist rooms. The idea behind it was „less is more“. It blends in perfectly with the arranged space.



It is, and as if it wasn't

The design of the cassette enables the door panel to be mounted discreetly. By using the same colour for the wall and the leaf, we create a unique colour scheme for the room.

The door becomes invisible, unobtrusive and unobtrusive in the interior.

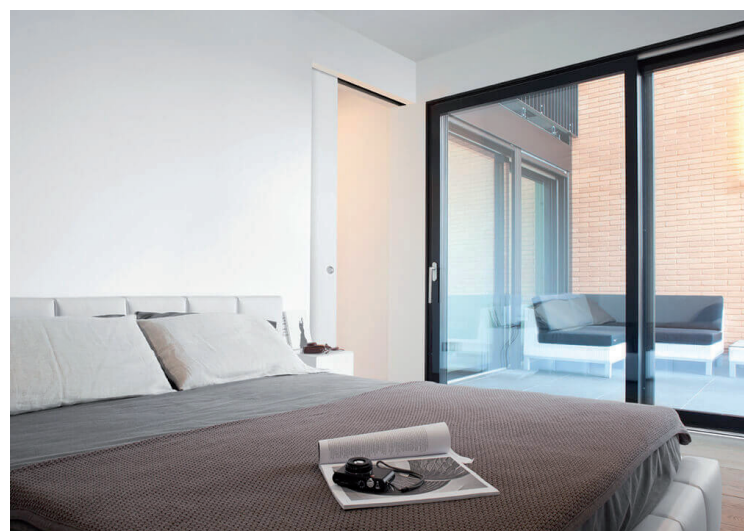

ECLISSE SYNTESIS® LINE

DO ŚCIANKI GIPS-KARTON

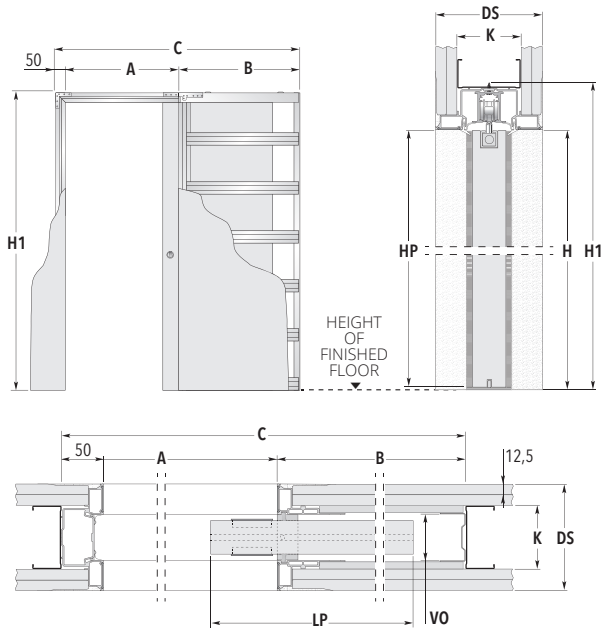

ECLISSE SYNTESIS® LINE PODWÓJNA

DO ŚCIANKI GIPS-KARTON

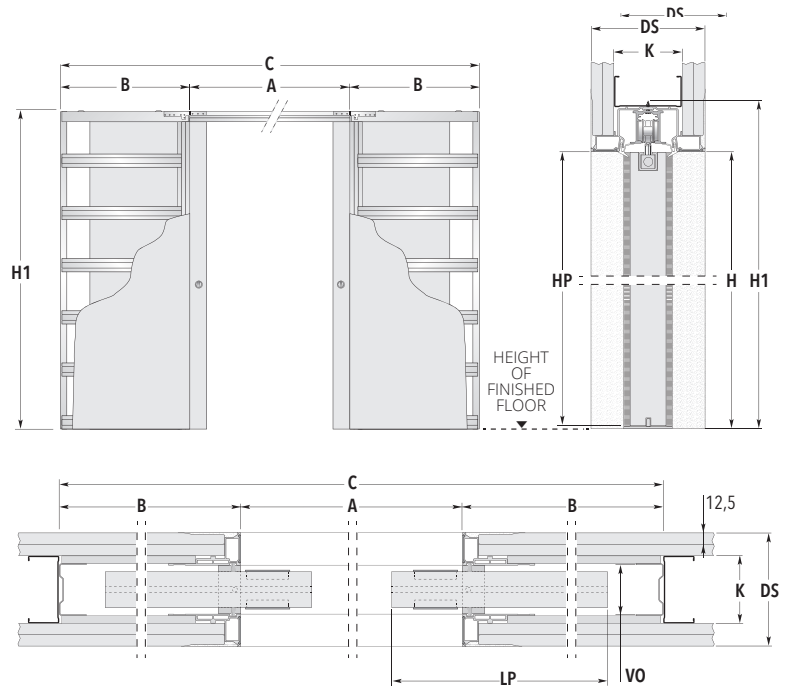

CASSETTE DIMENSION FOR SINGLE-LEAF DOORS

DOOR WIDTH	TRANSITION LIGHT A x H	B	EXTERNAL DIMENSIONS C x H1	LEAF DIMENSIONS	
				LP	HP
„60”	600 x 2048	750	1400 x 2108	625	2040
„70”	700 x 2048	850	1600 x 2108	725	2040
„80”	800 x 2048	950	1800 x 2108	825	2040
„90”	900 x 2048	1050	2000 x 2108	925	2040
„100”	1000 x 2048	1150	2200 x 2108	1025	2040

CASSETTE DIMENSION FOR DOUBLE DOORS

DOOR WIDTH	TRANSITION LIGHT A x H	B	EXTERNAL DIMENSIONS C x H1	LEAF DIMENSIONS	
				LP	HP
„60”+„60”	1200 x 2048	750	2700 x 2108	625	2040
„70”+„70”	1400 x 2048	850	3100 x 2108	725	2040
„80”+„80”	1600 x 2048	950	3500 x 2108	825	2040
„90”+„90”	1800 x 2048	1050	3900 x 2108	925	2040
„100”+„100”	2000 x 2048	1150	4300 x 2108	1025	2040

WALL THICKNESS = DS	INTERNAL DIMENSIONS = VS	PROFILES = K
100	54	75 single g/c board

ECLISSE SYNTESIS LINE CASSETTE DEDICATED TO FLAT SASHES (DOES NOT APPLY TO GLAZED LEAVES)

SYNTESIS LINE CASSETTE

single cassette, gypsum board version, 100 mm thick, H=2048mm, size „60”-„80”

single cassette, gypsum board version, 100 mm thick, H=2048mm, size „90”-„100”

double cassette, plasterboard version 100mm thick, H=2048mm, size „60”-„60” - „80”-„80”

double cassette, plasterboard version 100mm thick, H=2048mm, size „90”-„90” - „100”-„100”

LEGEND

A - Passage light
B - Cassette pocket dimension
C - Overall width of cassette
H - Clearance height
H1 - Total height of the cassette

N - Leaf width
HP - Casement height
DS - Total cassette thickness with g/k 100 mm
VO - Internal tray space 54 mm
K - 75 mm g/k profile

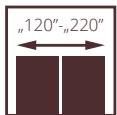
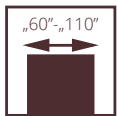

AKUSTIK 32dB

Mechanical class III

**NEW
MODEL**

- sound insulation
single leaf:
class D1 - 30, D2 - 25, class Rw=32 dB
- double leaf:
class D1 - 25, D2 - 25, Rw=27 dB class
- 3 mechanical strength class as per standard
PN-EN 1192:2001
- National Technical Assessment ITB-
KOT-2018/0407 Issue 2

AKUSTIK 32 dB mechanical class III door, fixed wooden frame

TECHNICAL DOORS



AKUSTIK 32dB mechanical class III single leaf door, adjustable wooden frame

**DOORS AKUSTIK 32 DB
MECHANICAL CLASS III ON
WOODEN FRAME**



VERSION full glazed full/full glazed/glassed full/glazed

**OPTIONAL
VERSIONS
GLAZING**



W1S W2S W3S W4S

**DIMENSIONS
DOOR**

Fixed wooden or adjustable frame:
 Door rebate system:
 Single leaf door:
 max. width "110" - 1212 mm, max. height 2500 mm
 90 Plus version (allows a minimum reveal of min. 900 mm when the leaf is opened by 90°) 1032x2075 mm
 Double leaf doors:
 max. width "110+110" - 2352 mm, max. height 2500 mm
 Fixed metal frame:
 Interlocking system:
 Single leaf door:
 max. width "110" - 1204 mm, max. height 2271 mm
 90 Plus version (allows a min. 900 mm when the leaf is opened by 90°) 1024x2071 mm
 Double leaf doors:
 max. width "110+110" - 2342 mm, max. height 2271 mm
 Adjustable metal frame:

Interlocking system:
 Single leaf door:
 max. width "110" - 1224 mm, max. height 2281 mm
 90 Plus version (allows a min. 900 mm when the leaf is opened by 90°) 1044x2081 mm
 Double leaf doors:
 max. width "110+110" - 2362 mm, max. height 2281 mm
 Non-standard door widths and heights are possible after consultation with the Sales Department.

INVESTMENT WIDTH
 90 plus door width to achieve a min. 900 mm when the leaf is opened by 90°.

LEAF FINISHING Smooth surface painted, veneered, covered with CPL laminate with a thickness of 0.2 to 0.7 mm, HPL laminate with a thickness of 0.7 to 1.0 mm or wood-like foil. Flat decors available, made of decorative mouldings, aluminium decors.

GLAZING Transparent glazing, pine frame painted, veneered or veneered with foil in a colour matching that of the sash. Porthole type glazing with Ø320 mm steel frame (on the outside of the frame) available.

FRAME Painted frame, veneered, covered with laminate
 CPL 0,15 mm, CPL 0,2 mm or foil matched to the colour of the leaf.
 Solid wooden pine - optionally with masking strips, quarter round.
 Wooden adjustable with widening panels, angle bands and cover strip.
 Metal frame made of 1.5 mm thick steel sheet, powder-coated as standard in white (RAL 9016 and RAL 9003), grey (RAL 9004) and black (RAL 9005).
 and RAL 9003), grey (RAL 7047), brown (RAL 8014), graphite (RAL 7024), black (RAL 9005) as standard.
 Adjustable metal frame made of 1.5 mm thick sheet steel powder-coated as standard in white (RAL 9016 and RAL 9003), grey (RAL 9016 and RAL 9003), brown (RAL 8014), graphite (RAL 7024), black (RAL 9005).
 and RAL 9003), grey (RAL 7047), brown (RAL 8014), graphite (RAL 7024), black (RAL 9005).
 It is possible to paint the door frames in non-standard RAL or NCS colours after consultation with the Sales Department.
 The frame consists of a main section and an angle band that slides into the main section.

ACCESSORIES AND EQUIPMENT **Standard equipment:**
 (doors with wooden or metal frame)
 - 3 or 4 pivot hinges adjustable in 3 planes made by OTLAV
 - mortise lock with a patent insert
 - drop seal

Additional equipment
 - aluminium decors
 - decorations
 - overhead or covered door closer, panic locks, anti-panic levers, electric door openers, electromagnetic jumper, reed switch, additional lock
 It is possible to prepare a milling cut in the leaf for a (electronic) hotel lock after consultation with the Sales Department.

DOOR LEAF ACOUSTIC 32 DB THIRD MECHANICAL CLASS FOR METAL DOOR FRAME



VERSION	full	glazed (W1S, W2S, W3S)	glazed (W4S)	full	glazed	full/glazed
---------	------	---------------------------	-----------------	------	--------	-------------

ADJUSTABLE AND FIXED METAL FRAME

FOR DOOR AKUSTIK 32 DB III MECHANICAL CLASS

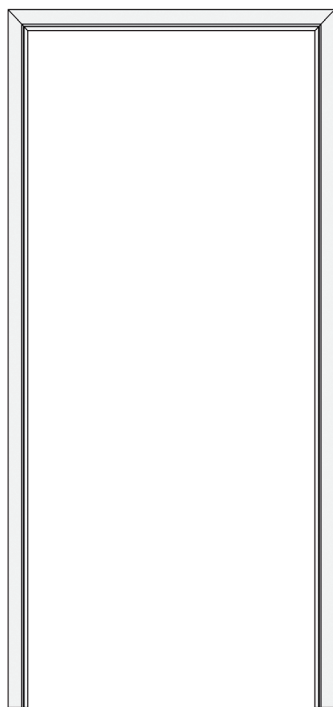

FIXED METAL FRAME			
for single leaf doors AKUSTIK 32 dB Mechanical class III			
symbol	range mm	„90”	„100”
UD	100		„110”

standard range 100 mm
widths of 100-150 mm available after consultation with the Sales Department

ADJUSTABLE METAL FRAME	
symbol	zakres mm
S30	100-130
S31	130-160
S32	160-190
S33	190-220
S34	220-250
S35	250-280
S36	280-310
S37	310-340
S38	340-370
S39	370-400

FIXED METAL FRAME									
WIDTH									
single-leaf doors					double doors				
type	S _o	S _c	H _o	H _c	typ	S _o	S _c	H _o	H _c
„60”	680	704			„120”	1320	1342		
„70”	780	804			„130”	1420	1442		
„80”	880	904			„140”	1520	1542		
„90”	980	1004	2060	2071	„150”	1620	1642		
„90” plus	1000	1024			„160”	1720	1742	2060	2071
„100”	1080	1104			„170”	1820	1842		
„110”	1180	1204			„180”	1920	1942		
					„190”	2020	2042		
					„200”	2120	2142		

ADJUSTABLE METAL FRAME									
WIDTH									
single-leaf doors					double doors				
type	S _o	S _c	H _o	H _c	typ	S _o	S _c	H _o	H _c
„60”	665	724			„120”	1303	1362		
„70”	765	824			„130”	1403	1462		
„80”	865	924			„140”	1503	1562		
„90”	965	1024	2055	2081	„150”	1603	1662		
„90” plus	985	1044			„160”	1703	1762	2055	2081
„100”	1065	1124			„170”	1803	1862		
„110”	1165	1224			„180”	1903	1962		
					„190”	2003	2062		
					„200”	2103	2162		

S_o - width of assembly opening
S_c - overall frame width

H_o - height of assembly opening
H_c - overall frame height

POL-SKONE RECEIVED THE PEFC CERTIFICATE FOR ITS PRODUCTS

PEFC is the world's largest forestry certification organisation.



NEW NATIONAL TECHNICAL ASSESSMENT FOR FRONT DOORS

We have obtained a revised National Technical Assessment for B-30, C-30, RC3, SR37, CERBER PLUS and CERBER PLUS RC2 doors. The National Technical Assessments will have the existing numbers ITB-KOT-2018/0713 and ITB-KOT-2019/0742 but will be marked with the 2nd edition. The documents have been updated and will be valid until December 2028.

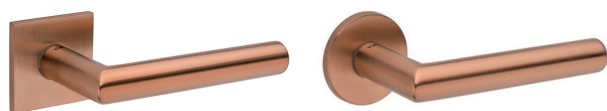

DEDICATED HANDLE COPPER IN COPPER COLOUR

INTERIOR DOORS

Non-standard sash sizes Estato, Estato Lux, Etiuda, Etiuda Lux, Creato (does not apply to Linea glass)

50 mm higher
150 mm higher

Non-standard sash dimensions Sempre, Sempre Lux (not applicable to WLZ, WLA/Z, W05 VERSE). 150 and 200 mm higher

up to 5 pcs.
over 5 pcs.

Unusual dimensions of Fortimo, Fortimo Lux, Mona wings. 50 mm and 100 mm higher

up to 5 pcs.
over 5 pcs.

Unusual leaf dimensions Fortimo, Fortimo Lux, Mona. 150 mm and 200 mm higher

up to 5 pcs.
over 5 pcs.

Unusual sash dimensions Intersolid, Intersolid II. 150 mm and 200 mm higher (only solid wings)

Non-standard dimensions of the Passo sash (not applicable to the W06 and W07 design). 50 mm and 100 mm higher

Unusual sash sizes Sedo, Modo, Veri, Egro rebated. 100 mm higher

up to 5 pcs.
over 5 pcs.

Unusual sash sizes Sedo, Modo, Veri, Egro rebated. 200 mm higher

up to 5 pcs.
over 5 pcs.

Non-standard door heights (minimum leaf height 1633 mm - rebated system, 1640 mm - non-rebated DUO system)

Lower from 100 - 400 mm, Sash with panel structure, full (does not apply to glazed), DIN frame, DIN DUO, wooden fixed, fixed wooden DUO, Harmony

Non-standard door widths

Doors with panel construction, possible narrowing to be agreed with the Technology Department.

ENTRY DOORS, TECHNICAL DOORS

Anti-theft bolts for doors EI30 Plus, FR EI30 system Pol Skone, EI60 Plus (2 bolts)

Width „60“, „70“ for entrance door RC3

Surcharge for milling for non-standard sign with access control for current mortise lock

Surcharge for milling for non-standard lock with access control*

* if a non-standard sheet is required