

 **POL-SKONE**[®]
DOORS AND WINDOWS



PRODUCT CATALOGUE 2024

Valid from 01.01.2024

ATTRIBUTES

SYSTEMS

DIMENSIONS

SPECIFICATIONS



- HIDDEN DOORS
- STEEL DOORS
- INTERIOR DOORS
- ENTRANCE DOORS
- SOUNDPROOF DOORS
- TECHNICAL DOORS
- SPECIAL DOORS
- DOOR FRAMES

STRUCTURE

RAIL AND STILE TYPE RAIL AND STILE TYPE



PANEL TYPE

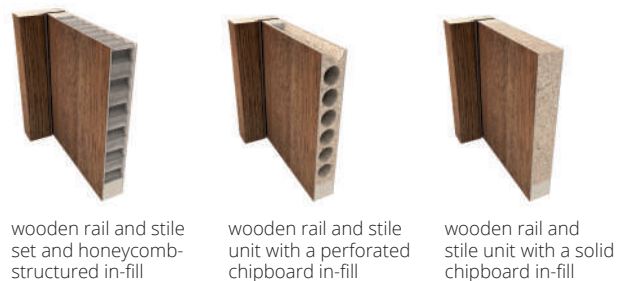

HOW TO PRICE A DOOR

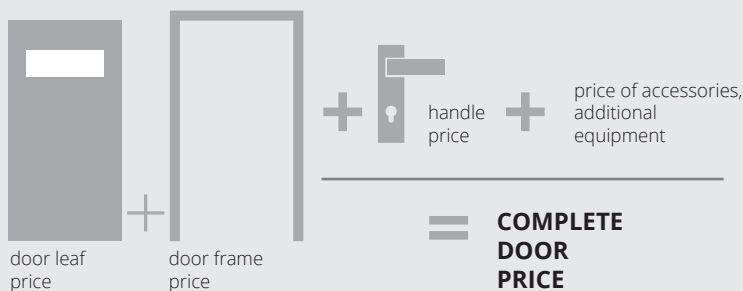

RIGHT-HAND or LEFT-HAND DOOR?

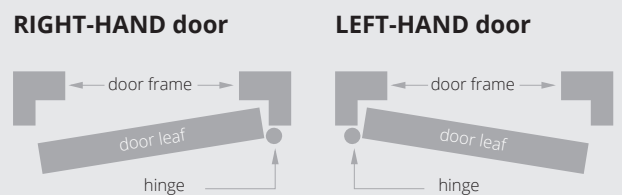

POL-SKONE FACTORIES



FACTORY Z1 LUBLIN



FACTORY AND SAWMILL Z2 NIEMCE



FACTORY Z4 LUBLIN



FACTORY AND SAWMILL Z3 BIŁGORAJ

VISION

As a Polish family business, we want to be the first choice brand in the premium segment.

MISSION

We are a manufacturer of top quality doors and windows. We build a strong brand associated with reliability, modern style design and technological innovation.

We are a family-owned company, so we care about long-term relationships with our business partners, and we treasure our employees as our most valuable asset.



Wood is the basic material from which we manufacture our products. The raw material comes from our own sawmills. To make doors, we use the best materials coming from reliable and experienced suppliers. In our production process we use the most state-of-the-art production lines.



The mark of responsible forestry

The FSC® certificate confirms that the raw materials used for our products come only from certified forests which are managed in accordance with applicable laws, good environmental and economic practices and with respect for the social values of local residents.

TABLE OF CONTENTS

INTERIOR HIDDEN DOORS

HARMONY	8
HARMONY INVEST	10
HARMONY INVEST PRO	12
HARMONY INVEST ULTRA - NEW	14
HARMONY MIRROR - NEW	16
SYSTEM FLEXI	17

INTERIOR STEEL DOORS

GALIO	20
GALIO DOUBLE-LEAF - NEW	22
SIDELIGHTS / TOPLIGHTS GALIO - NEW	24
STALIO	26

INTERIOR DOORS

RAIL AND STILE TYPE PAINTED DOORS

MODESTO - NEW	30
VILANO	32
VERTIGO	34
MODERN	36
MODENA	38
PALAZZO	40

PANELLED PAINTED DOORS

CAMBIO	42
ESTATO	44
TIARA - NEW PATTERNS	46
SUBLIME	48
SUBITO	50
SIMPLE	52
FIORD	54

RAIL AND STILE TYPE VENEERED DOORS

SEMPRE LUX	56
FORTIMO LUX	58
INTERSOLID	60
INTERSOLID II	62
PASSO	64

PANELLED VENEERED DOORS

ESPINA - NEW PATTERN	66
TEO - NEW	68
DECO LUX	70
ETIUDA LUX	72
ESTATO LUX	74
SONATA LUX	76

RAIL AND STILE TYPE LAMINATED DOORS

SEMPRE	78
FORTIMO	80
MONA	82
INVERNO	84
NOSTRE	86

RAIL AND STILE TYPE LAMINATED DOORS

SEDO - NEW PATTERNS	88
SAMOS - NEW	90
MODO	92
VERI	94
EGRO	96
ESTO - NEW	98
ARCO	100
UNITO - NEW	102
FIORI	104
ARIA - NEW	106

PANELLED LAMINATED DOORS

LOFTY	108
ZENN - NEW	110
DECO	112
HAPTIC	114
IMPULS	116
MAESTO - NEW	118
CREATO	120
ETIUDA	122
SONATA - NEW PATTERNS	124
INTER-AMBER	126

OTHER SYSTEMS

GLAZED LUMEN	128
GLAZED LUMEN LOFT	130
FOLDING	132

ENTRANCE DOORS

SPECIFICATION OF ACOUSTIC PARAMETERS	136
B-30/C-30	138
RC4	140
RC4 EI30	142
RC3 / RC3 INVEST	144
RC3 INVEST 37 DB	146
CERBER PLUS RC2	148
CERBER PLUS	150

TECHNICAL SOUNDPROOF DOORS

TYPE A/TYPE A DUO, TYPE B/TYPE B DUO	152
AKUSTIK 42 DB - NEW	154
SR 37 DB	156

TECHNICAL FIREPROOF DOORS

FR EI30	158
FR EI30 SR	160
ESCAPE DOORS	162
FR EI30 SR 42	164
EI30 PLUS REBATED	166
EI30 PLUS NON-REBATED	168
EI60 PLUS REBATED	170
EI60 PLUS NON-REBATED	172

ADJUSTABLE DOOR FRAMES FOR ENTRANCE DOORS	174
TECHNICAL DIMENSIONS	176
EI30 PLUS, EI60 PLUS LEAF	177
ADJUSTABLE METAL DOOR FRAME FOR EI30 PLUS, EI60 PLUS DOORS	178
ADJUSTABLE METAL DUO DOOR FRAME FOR EI30 PLUS, EI60 PLUS DOORS	179
FIXED METAL DOOR FRAME FOR EI30 PLUS, EI60 PLUS DOORS	180
FIXED METAL DUO DOOR FRAME FOR EI30 PLUS, EI60 PLUS DOORS	181
BESPOKE SYSTEMS WITH ARCHITRAVES	182
BESPOKE PANELLING SYSTEMS	183
ABS EDGING	184
WALL PANELS	184
DOORS FOR SHAFTS	185
TWO-COLOUR DOORS	185
FIRE PROTECTION SIDELIGHTS / TOPLIGHTS	186
DECORATION ELEMENTS	186
SPECIFICATION OF CYLINDERS	187
HANDLES FOR ENTRANCE AND EXTERIOR DOORS	187

TECHNICAL SPECIAL DOORS

HIGRO.....	188
GAMMA.....	190
SWING DOORS.....	192

TECHNICAL REINFORCED DOORS

G46.....	194
DECO INVEST.....	196
MECHANICAL CLASS III WITH BOARD STRUCTURE.....	198

CAMBIO DOOR LEAVES WITH PICTOGRAM.....	200
STAINLESS STEEL PANEL WITH ICONS.....	201
ALUMINIUM DECORS.....	201
ADDITIONAL EQUIPMENT.....	202

DOOR FRAMES

WOODEN DOOR FRAMES

FIXED POL-SKONE.....	210
FIXED DUO SYSTEM.....	211
ADJUSTABLE POL-SKONE SYSTEM.....	212
ADJUSTABLE SYSTEM DUO.....	213

DOOR FRAMES WITH MDF

FIXED MDF.....	214
ADJUSTABLE DIN SYSTEM.....	215
ADJUSTABLE AQUA DIN - NEW.....	216
ADJUSTABLE DIN DUO SYSTEM.....	217
ADJUSTABLE AQUA DIN DUO - NEW.....	218
ADJUSTABLE VERTIGO.....	219
ADJUSTABLE REVES SYSTEM.....	220
REVES SYSTEM (REVERSE REBATE).....	221
MDF-BASED ADJUSTMENT SYSTEM FOR FIXED METAL.....	222

METAL DOOR FRAMES

COLOURS METAL DOOR FRAMES.....	223
FIXED METAL DUO POL-SKONE SYSTEM.....	224
FIXED METAL POL-SKONE SYSTEM.....	225
ADJUSTABLE METAL DUO POL-SKONE SYSTEM.....	226
ADJUSTABLE METAL POL-SKONE SYSTEM.....	227
FIXED METAL DIAGONAL POL-SKONE SYSTEM.....	228
ADJUSTABLE METAL DIAGONAL POL-SKONE SYSTEM.....	229
FIXED METAL LUMEN.....	230
ADJUSTABLE METAL LUMEN.....	231

TUNNELS AND TOPLIGHTS / SIDELIGHTS

TUNNELS / WALL CASING SYSTEMS.....	232
TOPLIGHTS / SIDELIGHTS FOR DIN/DIN DUO DOOR FRAME.....	234
SIDELIGHTS / TOPLIGHTS FOR FIXED DOOR FRAME.....	235
SEMPRE INTERIOR DOOR SIDE PANELS.....	235
METAL TOPLIGHTS/SIDELIGHTS.....	236

STRIPS.....	237
BASEBOARDS.....	237

SLIDING SYSTEMS

SLIDING SYSTEM FOR IN-WALL INSTALLATION.....	238
SLIDING SYSTEM ON-WALL.....	240
SLIDING SYSTEM ON-WALL PREMIUM.....	242
SLIDING SYSTEM ON-WALL MOVI.....	243

ACCESSORIES

VENTILATION OPTIONS.....	244
STAINLESS STEEL PROTECTORS.....	247
PORHOLE.....	248
CROWNS.....	248
ACCESSORIES.....	249
HANDLES FOR INTERIOR DOORS.....	251
CYLINDERS.....	253

ADDITIONAL INFORMATION

ADDITIONAL INFORMATION.....	254
INTERIOR DOOR FOR ROOMS WITH THE RECUPERATION SYSTEM.....	255
IMPORTANT USER INFORMATION.....	256
TECHNICAL DIMENSIONS.....	257
DIMENSIONS OF INTERIOR DOOR LEAVES.....	260

COLOURS

STANDARD COLOURS.....	261
HPL LAMINATES.....	265
HPL LAMINATES WITH ANTIBACTERIAL COATING.....	265

STANDARD PARAMETERS OF POL-SKONE DOORS.....	266
---	-----

NOTE!

WE WILL SOON INTRODUCE NEW PRODUCT CODES (NEW DOOR VERSION DESIGNATIONS)

You can find them next to the icons of the individual door models, e.g:

previous code → **W02** / **V4S4** ← new code

For detailed
information,
scan the QR code:



HIDDEN DOOR

unlimited possibilities

- **HARMONY** - p. 8
- **HARMONY INVEST** - p. 10
- **HARMONY INVEST PRO** - p. 12
- **HARMONY ULTRA** - p. 14
- **HARMONY MIRROR** - p. 16
- **Flexi system for HARMONY door frame** - p. 17



HARMONY door with HARMONY hidden door frame

HARMONY POL-SKONE SYSTEM

**HIDDEN
DOOR**

Preparation of the door leaf for the installation of a one-sided mirror or a 4 mm thick plate (thinned ODZ and ODW door leaf)+58 (solid panel and additional hinge required: number of hinges "60-80" - 3 pcs, "90-100" - 4 pcs; it is recommended to fit the handle on a split backplate; maximum height of door leaf prepared for a mirror is 2250/2240 mm

- the leaf structure consists of a **coniferous wood rail and stile set** topped with HDF panels on both sides
- door leaf rated **thickness 40 mm**
- door leaf is designed **so as to be installed flush with the door frame surface**
- smooth surface **HARMONY IDEA**, prime coated for do-it-yourself painting, laminated, painted or veneered

mechanical class: mechanical resistance requirements class 2 i.e. average service conditions single door leaf with HARMONY hidden door frame with solid board in-fill, fitted with a drop gasket, with a sound insulation value of **Rw=27 dB**

MOST FREQUENTLY CHOSEN SETS DOOR LEAF + HARMONY DOOR FRAME

door leaf in paper for painting HARMONY IDEA* for do-it-yourself painting + raw ALU door frame for do-it-yourself painting



raw leaf with prime coating for do-it-yourself painting* +raw ALU door frame for do-it-yourself painting



Door leaf painted with UV paints (white)* +raw ALU door frame for do-it-yourself painting

* only applicable to door leaves with a width of "60"-90" cm x height 2050/2040 mm, honeycomb-structured in-fill

HARMONY DOOR LEAF **HARMONY IDEA - open to your interior arrangement ideas**

door leaf dimensions	HARMONY IDEA	raw leaf with base coating for DIY painting	LAMISTONE	PAINTED white	PAINTED grey, beige	BLACK black, sage	VENEERED		
			SILKSTONE	white hinges	grey, beige white hinges	black hinges	GROUP A	GROUP B	GROUP C, D
"60"- "90" x 2050/2040 mm									
"100" x 2050/2040 mm									
"60"- "90" x 2150/2140 mm									
"100" x 2150/2140 mm									
"60"- "90" x 2250/2240 mm									
"100" x 2250/2240 mm									
"60"- "90" x 2350/2340 mm									
"100" x 2350/2340 mm									
"60"- "90" x 2450/2440 mm									
inward opening door – door leaf height 2050 mm									
outward opening door – door leaf height 2040 mm									

DOOR FRAMES

FOR SINGLE-LEAF DOOR

door leaf dimensions and number of hinges	for do-it-yourself painting (raw aluminium)	anodised aluminium	PAINTED white, grey, beige	BLACK black, sage
			white hinges	black hinges
"60"- "80" x 2050 / 2040 mm (2 hidden hinges)				
"90"- "100" x 2050 / 2040 mm (3 hidden hinges)				
"60"- "100" x 2150 / 2140 mm (3 hidden hinges)				
"60"- "100" x 2250 / 2240 mm (3 hidden hinges)				
"60"- "100" x 2350 / 2340 mm (4 hidden hinges)				
"60"- "100" x 2450 / 2440 mm (4 hidden hinges)				

single-leaf door					double-leaf door				
type	S _d *	S _d **	S _o	S _s	type	S _d *	S _o *	S _d **	S _o **
"60"	693	696	710	625	"60"+ "60"	1309	1325	1315	1330
"70"	793	796	810	725	"70"+ "70"	1509	1525	1515	1530
"80"	893	896	910	825	"80"+ "80"	1709	1725	1715	1730
"90"	993	996	1010	925	"90"+ "90"	1909	1925	1915	1930
"100"	1093	1096	1110	1025	"100"+ "100"	2109	2125	2115	2130

* outward opening door ** inward opening door;
 S_d, H_d - door width/height on the door frame external side
 S_o, H_o - width/height of the installation opening
 S_s - width of the door leaf

H _d	H _o
2082*	2090*
2092**	2100**

FOR DOUBLE-LEAF DOOR

door leaf dimensions and number of hinges	for do-it-yourself painting (raw aluminium)	anodised aluminium	PAINTED white, grey, beige	BLACK black, sage
			white hinges	black hinges
"60"+ "60", "70"+ "70", "80"+ "80" x 2050/2040 mm (4 hidden hinges)				
"90"+ "90", "100"+ "100" x 2050/2040 mm (6 hidden hinges)				
"60"+ "60", "70"+ "70", "80"+ "80", "90"+ "90", "100"+ "100" x 2150/2140 mm (6 hidden hinges)				
"60"+ "60", "70"+ "70", "80"+ "80", "90"+ "90", "100"+ "100" x 2250/2240 mm (6 hidden hinges)				
"60"+ "60", "70"+ "70", "80"+ "80", "90"+ "90", "100"+ "100" x 2350/2340 mm (8 hidden hinges)				
"60"+ "60", "70"+ "70", "80"+ "80", "90"+ "90", "100"+ "100" x 2450/2440 mm (8 hidden hinges)				

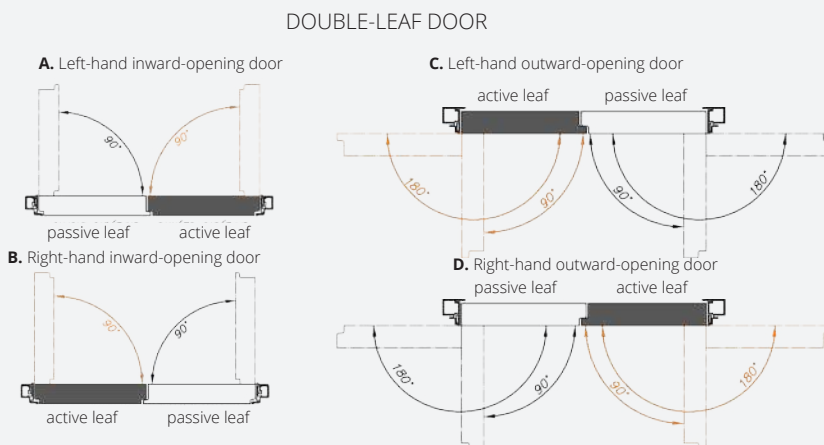
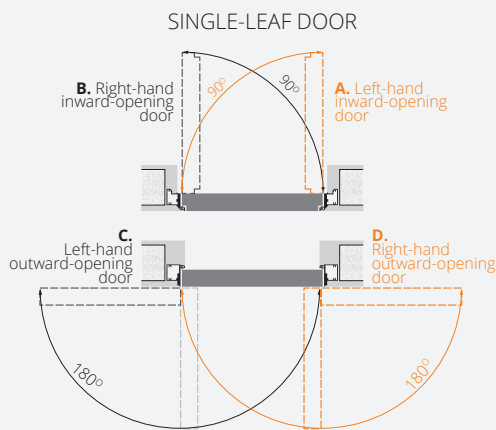

EQUIPMENT

STANDARD		
hidden hinge (adjustable in 3 planes), colour: chrome satin- number of hinges as per table, key-operated or WC	recuperation trim	without an extra charge
magnetic lock for cylinder, key or WC	HARMONY door leaf shortened every 10 mm - max. shortening: 100 mm	without an extra charge
inward-opening - not available with the ABS edge	HARMONY door leaf shortened above 100 mm	subject to consultation with the Sales Department
ADDITIONAL (available at an extra charge)		
perforated chipboard in-fill	door frames in metallic colours (p. 223)	+10%
solid chipboard in-fill	door frame adaptation to the HOBES 2784 roller lock	
drop seal	door frame available with electric NO strike or electric NC strike	p. 205
hidden hinge in the colour of white, black or silver	HARMONY door frame trimmed every 10 mm is available - the maximum trim is 100 mm	without an extra charge
ventilation undercut	Double-leaf door with an asymmetric division line is available on request	
HOBES 2784 roller lock		
preparation for an extra hinge (extra charge added to the door leaf price)		
for other door dimensions – contact the Sales Department	+10%	

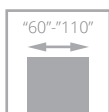

HARMONY INVEST door with HARMONY INVEST aluminium door frame

HARMONY INVEST

HIDDEN DOOR

- **robust structure - wooden rail and stile set** reinforced with a special steel profile
- **wide range of colours** from collections ECO TOP, LAMINATED CPL, LAMISTONE CPL, SILKSTONE and UNI MAT PLUS, natural or painted veneers
- door leaf equipped with **drop seal**
- **acoustic insulation capacity** $R_w=37\text{dB}$
- **aluminium door frame**, reinforced
- door leaf rated **thickness 50 mm**

Interior entrance door for rooms in public buildings including offices, hotels etc.

door width "60" - "90" - mechanical resistance class 4 acc. to PN-EN 1192:2001
 door width "90 plus" - "110" - mechanical resistance class 3 acc. to PN-EN 1192:2001
 Acoustic insulation capacity: $R_w= 37 \text{ dB}$, D_1-35 , D_2-30
 National Technical Assessment **ITB-KOT-2022/2187** release 1



HARMONY INVEST door with aluminium door frame



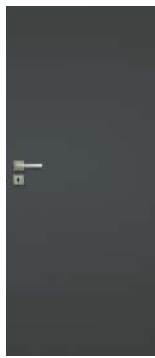

raw for do-it-yourself painting

LAMISTONE CPL
UNI MAT PLUS
SILKSTONE
SILKSTONE CPL 0.5 mm
LAMINATED CPL 0.2 mm
PAINTED – white
PAINTED – grey, beige
PAINTED – black, sage
VENEERED GROUP A
VENEERED GROUP B
VENEERED GROUP C, D
SILKWOOD

extra charge added to the basic colour white RAL 9003 acc. to RAL, NCS colour groups (p. 264)

GROUP I	GROUP II	GROUP III	GROUP IV	GROUP V
---------	----------	-----------	----------	---------

extra charge CPL 0.5 mm, CPL 0.7 mm to door in CPL laminate coating

CPL 0.5 mm ("60" - "80")	CPL 0.7 mm ("60" - "80")	CPL 0.5 mm ("90" - "110")	CPL 0.7 mm ("90" - "110")
--------------------------	--------------------------	---------------------------	---------------------------

*available at extra charge subject to consultation with the Sales Department

VERSION W00 / V00

COLOURS

LAMISTONE CPL	SILKSTONE	SILKSTONE CPL 0.5 mm	UNI MAT PLUS
LAMINATED CPL 0.2 mm	LAMINATED CPL 0.5 mm	LAMINATED HPL*	VENEERED GROUP A
VENEERED GROUP B	VENEERED GROUP C	VENEERED GROUP D	SILKWOOD
			PAINTED

DOOR FRAMES

HARMONY INVEST DOOR FRAME FOR SINGLE-LEAF DOOR

door leaf dimensions [mm]	quantity of hinges	for do-it-yourself painting	anodised aluminium	PAINTED white	PAINTED grey, beige	BLACK black, sage
625-960 x 2050/2040	2 pcs					
1025-1125 x 2050/2040	3 pcs					
625-960 x 2150/2140	3 pcs					
1025x1125 x 2150/2140	3 pcs					
625-960 x 2250/2240	3 pcs					
1025x1125 x 2250/2240	3 pcs					
625-960 x 2350/2340	3 pcs					
1025-1125 x 2350/2340	3 pcs					
625-960 x 2450/2440	3 pcs					
1025-1125 x 2450/2440	3 pcs					

extra charge for structural colours +10%

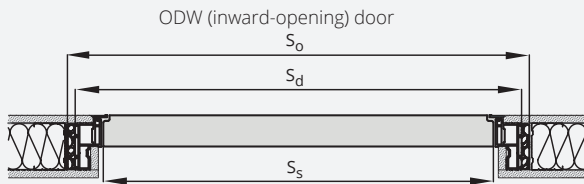

ODW INWARD-OPENING DOOR

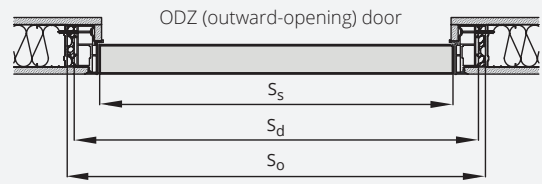

OUTWARD-OPENING DOOR ODZ

WIDTH [MM]			HEIGHT [MM]			
Ss	Sd	So	Hs	Hd	Ho	
"60"	625	715	735	1950	2002	2015
"70"	725	815	835	2050 - standard	2102	2115
"80"	825	915	935	2150	2202	2215
"90"	925	1015	1035	2250	2302	2315
„90 plus“*	960	1050	1070	2350	2402	2415
"100"	1025	1115	1135	2450	2502	2515
"110"	1125	1215	1235			

WIDTH [MM]			HEIGHT [MM]			
Ss	Sd	So	Hs	Hd	Ho	
"60"	625	715	735	1940	1992	2005
"70"	725	815	835	2040 - standard	2092	2105
"80"	825	915	935	2140	2192	2205
"90"	925	1015	1035	2240	2292	2305
„90 plus“*	960	1050	1070	2340	2392	2405
"100"	1025	1115	1135	2440	2492	2505
"110"	1125	1215	1235			

* width for public utility buildings

EQUIPMENT

STANDARD	
magnetic mortise lock, for key (spacing: 90 mm), for cylinder (spacing: 85 mm) or bathroom privacy lock (spacing: 90 mm)	width "100" +10%
door frame colour anodised aluminium or for do-it-yourself painting – TECTUS TE 340 hinges, colour chrome satin, strike plate colour silver	width "110" +20%
door frame painted RAL 9003 – TECTUS TE 340 hinges colour chrome satin, strike plate colour chrome satin	higher door - 2150/2140 +10%
door frame painted RAL 9005 – TECTUS TE 340 hinges colour black, strike plate colour black	higher door - 2250/2240 +20%
SIMONSWERK hidden hinges, type TECTUS TE 340 adjustable 3D ("60"- "90" – 2 pcs, "100"- "110" – 3 pcs) door higher than standard – 3 pcs drop seal	higher door - 2350/2340 +30%
	higher door - 2450/2440 +40%
	ventilation undercut ** p. 245
ADDITIONAL (available at an extra charge)	BIRA HARTTE XS NARROW electric strike with tongue guide (NO type) XS12R-C 12V DC (including SPEC 525 strike plate and milling for the electric strike)**
CPL laminate 0.5 mm ("60" - "90")*	BIRA HARTTE XS NARROW electric strike with tongue guide (NC type) XS12U-C 12V AC/DC (including SPEC 525 strike plate and milling for the electric strike)**
CPL laminate 0.7 mm ("60" - "90")*	BIRA HARTTE XS NARROW electric strike with tongue guide (NC type with off-switch) XS12UW-C 12V AC/DC (including SPEC 525 strike plate and milling for the electric strike)***
CPL laminate 0.5 mm ("90+" - "110")*	
CPL laminate 0.7 mm ("90+" - "110")*	
recuperation trim**	
GEZE BOXER 2-4 hidden door closer	

* extra charge to standard door height

**door with recuperation trim or ventilation undercut does not have a drop seal and does not deliver the declared acoustic and air permeability performance.

*** if an electric strike is used, it is necessary to change to the ECO Schulte GBS 12 lock, extra charge

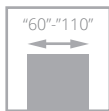

acoustic
insulation
Rw = 37dB



HARMONY INVEST PRO FOR PANELLING SYSTEM

HIDDEN DOOR

- **robust structure - wooden rail and stile set** reinforced with a special steel profile
- **aluminium frame**, reinforced to form one on-wall panel surface (13 mm thick) with door leaf
- **wide range of colours** from collections ECO TOP, LAMINATED CPL, LAMISTONE CPL, SILKSTONE and UNI MAT PLUS, natural or painted veneers
- door leaf equipped with **drop seal**
- **acoustic insulation capacity** $R_w = 37\text{dB}$
- door leaf rated **thickness 50 mm**

Interior entrance door for use in public buildings including offices, hotels, etc.

outward-opening door ODZP width "60" - "90" **mechanical resistance class 4** acc. to PN-EN 1192:2001

outward-opening door ODZP width "90 plus" - "110" **mechanical resistance class 3** acc. to PN-EN 1192:2001

outward-opening door ODWP width "60" - "110" **mechanical resistance class 3** acc. to PN-EN 1192:2001

acoustic insulation capacity: $R_w = 37\text{ dB}$, D1-35, D2-30

National Technical Assessment **ITB-KOT-2022/2187** release 1

HARMONY INVEST PRO door with HARMONY INVEST aluminium door frame and panelling system



HARMONY INVEST door with aluminium door frame



HARMONY INVEST PRO DOOR LEAF AND PANEL

colours	door leaf	panel*
raw for do-it-yourself painting		
LAMISTONE CPL		
UNI MAT PLUS		
SILKSTONE		
SILKSTONE CPL 0.5 mm		
LAMINATED CPL 0.2 mm		
PAINTED – white		
PAINTED – grey, beige		
PAINTED – black, sage		
VENEERED GROUP A		
VENEERED GROUP B		
VENEERED GROUP C		
SILKWOOD		

* 13 mm thick panels for the system price per m²
 Maximum panel dimensions: width 1100 mm x height 2500 mm
 - extra charge added to dimensions 2301 – 2500 mm **+10%** to price per m²
 - extra charge added to dimensions 80 – 299 mm **+10%** to price per m²

NOTE! For panels with a height of 2200 - 2500 mm, veneer has visible finger joints.

extra charge added to the basic colour white RAL 9003 acc. to RAL, NCS colour groups (p. 264)

GROUP I	GROUP II	GROUP III	GROUP IV	GROUP V

extra charge CPL 0.5 mm, CPL 0.7 mm to door in CPL laminate coating

CPL 0.5 mm ("60" - "80")	CPL 0.7 mm ("60" - "80")	CPL 0.5 mm ("90" - "110")	CPL 0.7 mm ("90" - "110")

VERSION W00 / V00

COLOURS

LAMISTONE CPL	SILKSTONE	SILKSTONE CPL 0.5 mm		
UNI MAT PLUS	LAMINATED CPL 0.2 mm	LAMINATED CPL 0.5 mm	LAMINATED HPL*	
VENEERED GROUP A	VENEERED GROUP B	VENEERED GROUP C	SILKWOOD	PAINTED

*available at extra charge subject to consultation with the Sales Department

DOOR FRAMES

HARMONY INVEST PRO ALUMINIUM DOOR FRAME FOR PANEL

ODW				ODZ				
door leaf dimensions [mm]	raw for do-it-yourself painting	PAINTED white	PAINTED grey, beige	BLACK black, sage	raw for do-it-yourself painting	PAINTED white	PAINTED grey, beige	BLACK black, sage
625-960 x 2050/2040								
1025-1125 x 2050/2040								
625-960 x 2150/2140								
1025x1125 x 2150/2140								
625-960 x 2250/2240								
1025x1125 x 2250/2240								
625-960 x 2350/2340								
1025-1125 x 2350/2340								
625-960 x 2450/2440								
1025-1125 x 2450/2440								

extra charge for structural colours **+10%**

Inward-opening door for panelling system

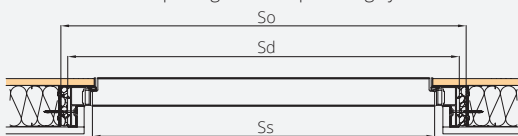

Outward-opening door for panelling system

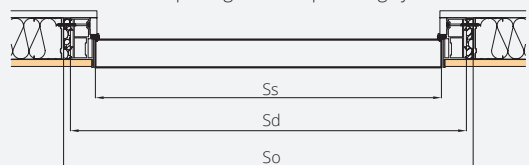

ODW INWARD-OPENING DOOR

WIDTH [MM]	HEIGHT [MM]		
	Ss	Sd	So
"60"	625	715	735
"70"	725	815	835
"80"	825	915	935
"90"	925	1015	1035
"90 plus" *	960	1050	1070
"100"	1025	1115	1135
"110"	1125	1215	1235

* width for public utility buildings

Ss - door leaf width
 Sd - door width on the door frame external side
 So - installation opening width

OUTWARD-OPENING DOOR ODZ

WIDTH [MM]	HEIGHT [MM]		
	Ss	Sd	So
"60"	625	715	735
"70"	725	815	835
"80"	825	915	935
"90"	925	1015	1035
"90 plus" *	960	1050	1070
"100"	1025	1115	1135
"110"	1125	1215	1235

Hs - door leaf height
 Hd - door height on the door frame external side
 Ho - installation opening height

EQUIPMENT

* extra charge to standard door height

**door with recuperation trim or ventilation undercut does not have a drop seal and does not deliver the declared acoustic and air permeability performance.

STANDARD
magnetic mortise lock, for key (spacing: 90 mm), for cylinder (spacing: 85 mm) or bathroom privacy lock (spacing: 90 mm)
outward-opening: SIMONSWERK hidden hinges, type TECTUS TE 541 3D FVZ adjustable 3D ("60"- "90" – 2 pcs, "100"."110" – 3 pcs)
inward-opening: SIMONSWERK hidden hinges, type TECTUS TE 240 3D adjustable 3D ("60"- "110" – 3 pcs)
door higher than standard – 3 pcs
drop seal
not available with an electric door strike
ADDITIONAL (available at an extra charge)
CPL laminate 0.5 mm ("60" - "90")*
CPL laminate 0.7 mm ("60" - "90")*
CPL laminate 0.5 mm ("90+" - "110")*
CPL laminate 0.7 mm ("90+" - "110")*
recuperation trim**

width "100"	+10%
width "110"	+20%
change of hinge colour to black, white	
ventilation undercut **	p. 245
higher door - 2150/2140	+10%
higher door - 2250/2240	+20%
higher door - 2350/2340	+30%
higher door - 2450/2440	+40%
wall panel wood grain suited to fit the door acc. to pattern (fitting tolerance up to 10 mm) (extra charge to prices of panels)	+20%
GEZE BOXER 2-4 door closer	

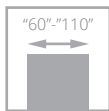

HARMONY INVEST ULTRA door with HARMONY ULTRA aluminium door frame

HARMONY INVEST ULTRA

NEW

HIDDEN DOOR

- door on hidden frame without lintel
- the latest design trend, perfectly suited for modern interiors

- **robust structure - wooden rail and stile set** reinforced with a special steel profile
- **wide range of colours** from collections ECO TOP, LAMINATED CPL, LAMISTONE CPL, SILKSTONE and UNI MAT PLUS, natural or painted veneers
- **aluminium door frame**, reinforced
- **door leaf rated thickness 50 mm**

Interior entrance door for use in public buildings including offices, hotels, etc.

door width "60" - "90" - **mechanical resistance class 4** acc. to PN-EN 1192:2001
 door width "90 plus" - "110" - **mechanical resistance class 3** acc. to PN-EN 1192:2001
 National Technical Assessment ITB-KOT-2022/2187
 release 1



HARMONY INVEST ULTRA door with aluminium door frame



raw leaf, prime coated for do-it-yourself painting
LAMISTONE CPL
UNI MAT PLUS
SILKSTONE
SILKSTONE CPL 0.5 mm
LAMINATED CPL 0.2 mm
PAINTED – white
PAINTED – grey, beige
PAINTED – black
VENEERED GROUP A
VENEERED GROUP B
VENEERED GROUP C

VERSION **W00**

COLOURS

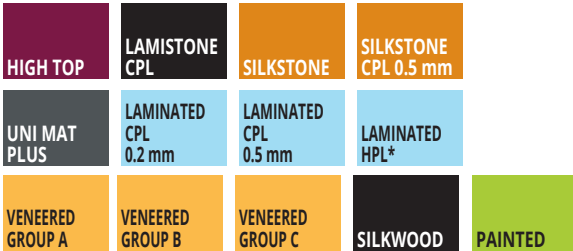

extra charge added to the basic colour white (RAL 9003) acc. to RAL, NCS colour groups

GROUP I	GROUP II	GROUP III	GROUP IV	GROUP V
---------	----------	-----------	----------	---------

extra charge CPL 0.5 mm, CPL 0.7 mm to door in CPL laminate coating (extra charge to standard door height)

CPL 0.5 mm ("60" - "90")	CPL 0.7 mm ("60" - "90")	CPL 0.5 mm ("90+" - "110")	CPL 0.7 mm ("90+" - "110")
--------------------------	--------------------------	----------------------------	----------------------------

*available at extra charge subject to consultation with the Sales Department

DOOR FRAMES

HARMONY INVEST ULTRA ALUMINIUM FRAME

dimensions provided for door leaf	raw for do-it-yourself painting	anodised aluminium	PAINTED white	PAINTED grey, beige	BLACK black, sage
625-960 x 2040 (2 hinges)					
1025-1125 x 2040 (3 hinges)					
625-1125 x 2140 (3 hinges)					
625-1125 x 2240 (3 hinges)					
625-1125 x 2340 (3 hinges)					
625-1125 x 2440 (3 hinges)					
extra charge for structural colours +10%					

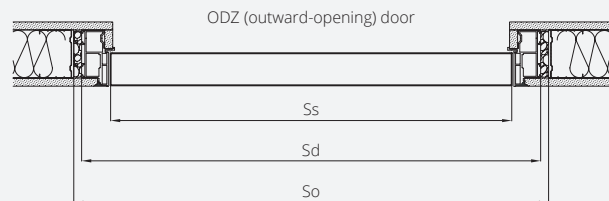
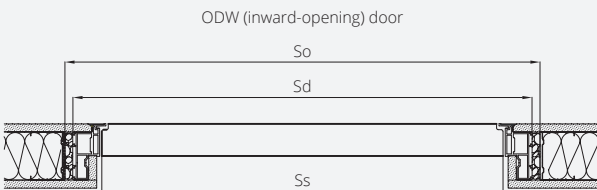

INWARD-OPENING DOOR ODW / OUTWARD-OPENING DOOR ODZ

	WIDTH [MM]			HEIGHT [MM]		
	Ss	Sd	So	Hs	Hd	Ho
"60"	625	715	735	1940	1952	1955
"70"	725	815	835	2040 - standard	2052	2055
"80"	825	915	935	2140	2152	2155
"90"	925	1015	1035	2240	2252	2255
"90 plus"	960	1050	1070	2340	2352	2355
"100"	1025	1115	1135	2440	2452	2455
"110"	1125	1215	1235			

Ss - door leaf width
Sd - door width on the door frame external side
So - installation opening width

Hs - door leaf height
Hd - door height on the door frame external side
Ho - installation opening height

* width for public utility buildings - 90 plus version allows to get the clear opening of min. 900 mm with the door leaf opening angle 90°.

EQUIPMENT

STANDARD	
magnetic mortise lock, for key (spacing: 90 mm), for cylinder (spacing: 85 mm) or bathroom privacy lock (spacing: 90 mm)	CPL laminate 0.5 mm ("90+" - "110")*
door frame colour anodised aluminium or for do-it-yourself painting – TECTUS TE 340 hinges, colour chrome satin, strike plate colour silver	CPL laminate 0.7 mm ("90+" - "110")*
door frame painted RAL 9003 – TECTUS TE 340 hinges colour chrome satin, strike plate colour chrome satin	width "100" +10%
SIMONSWERK hidden hinges, type TECTUS TE 340 adjustable 3D ("60"- "90" – 2 pcs, "100"- "110" – 3 pcs) door higher than standard – 3 pcs-recuperation trim	width "110" +20%
ADDITIONAL (available at an extra charge)	ventilation undercut p. 245
TECTUS TE 340 3D hinge colour change to black	mortise latch-and-deadbolt lock
CPL laminate 0.5 mm ("60" - "90")*	electric NC or NO strike
CPL laminate 0.7 mm ("60" - "90")*	higher door - 2150/2140 +10%
	higher door - 2250/2240 +20%
	higher door - 2350/2340 +30%
	higher door - 2450/2440 +40%

* extra charge added to standard door height

NEW

EXPAND OPTICALLY YOUR SPACE

HARMONY MIRROR

door prepared for installing a mirror to form a uniform surface with the mirror glued onto the wall

- door leaf thickness 40 mm
- infill: perforated board
- outward-opening

HARMONY MIRROR ODZ DOOR LEAF

OUTWARD-OPENING DOOR ODZ

door leaf dimensions [mm]	raw for do-it-yourself painting	LAMISTONE	PAINTED white	PAINTED grey, beige	BLACK black, sage	VENEERED GROUP A	VENEERED GROUP B	VENEERED GROUP C, D
		SILKSTONE						
		UNI MAT PLUS						
"60"- "90" x 2040								
"100" x 2040								
"60"- "90" x 2140								
"100" x 2140								
"60"- "90" x 2240								
"100" x 2240								

door leaf in standard version with perforated board

additional hidden hinge for Harmony Mirror door frame
ventilation undercut available

HARMONY MIRROR ODZ DOOR FRAME

OUTWARD-OPENING DOOR FRAME ODZ

door leaf dimensions [mm]	number of hinges	raw for do-it-yourself painting	anodised aluminium	PAINTED - white, grey (RAL 7047), beige (NCS S 2005 Y50R), black
"60"- "80" x 2040	3			
"90"- "100" x 2040	3			
"60"- "100" x 2140	4			
"60"- "100" x 2240	4			



SYSTEM FLEXI

POL-SKONE FOR HARMONY DOOR FRAME

**PATENTED
PATTERN**

MDF adjustment system for door frame **HARMONY, HARMONY MIRROR**



symbol	range in mm*	symbol	range in mm*	ECO TOP	PAINTED** white	PAINTED** grey, beige	BLACK black, sage	UNI MAT PLUS LAMISTONE SILKSTONE	veneered
HW1	85-90	HZ1	95-100						GROUP A (311, 312, 334)
HW2	90-95	HZ2	100-105						GROUP B (323, 370, 372, 390, 404, 405, 421, 422, 424)
HW3	95-105	HZ3	105-115						
HW4	105-130	HZ4	115-140						
HW5	130-150	HZ5	140-160						
HW6	150-170	HZ6	160-180						
HW7	170-190	HZ7	180-200						
HW8	190-210	HZ8	200-220						
HW9	210-230	HZ9	220-240						
HW10	230-250	HZ10	240-260						
HW11	250-270	HZ11	260-280						
HW12	270-290	HZ12	280-300						
HW13	290-310	HZ13	300-320						

* the adjustment range takes into account the thickness of the given aluminium frame

** only available with 80 mm wide architraves

SPECIFICATION OF COMPLETE SETS OF COMPONENTS

	adjustment range	HARMONY door frame ODW	adjustment range	HARMONY door frame ODZ	adjustment angle architrave	panel
HW1	85-90		HZ1	95-100	12 mm	46 mm
HW2	90-95		HZ2	100-105	12 mm	51 mm
HW3	95-105		HZ3	105-115	16 mm	56 mm
HW4	105-130		HZ4	115-140	32 mm	66 mm
HW5	130-150	HARMONY inward-opening door frame ODW	HZ5	140-160	32 mm	91 mm
HW6	150-170		HZ6	160-180	32 mm	111 mm
HW7	170-190		HZ7	180-200	32 mm	131 mm
HW8	190-210		HZ8	200-220	32 mm	151 mm
HW9	210-230		HZ9	220-240	32 mm	171 mm
HW10	230-250		HZ10	240-260	32 mm	191 mm
HW11	250-270		HZ11	260-280	32 mm	211 mm
HW12	270-290		HZ12	280-300	32 mm	231 mm
HW13	290-310		HZ13	300-320	32 mm	251 mm

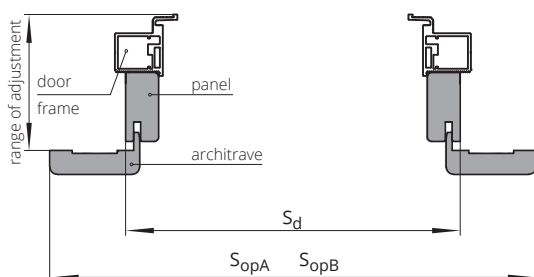

Sd – casing width

SopA – width on the external side of the architrave “60 mm”

SopB – width on the external side of the architrave “80 mm”

Hd – casing height

HopA – height on the external side of the architrave “60 mm”

HopB – height on the external side of the architrave “80 mm”

Casing dimension	inward-opening						outward-opening					
	Sd	SopA	SopB	Hd	HopA	HopB	Sd	SopA	SopB	Hd	HopA	HopB
“60”	683	783	823				663	763	803			
“70”	783	883	923				763	863	903			
“80”	883	983	1023	2086	2136	2156	863	963	1003	2067	2117	2137
“90”	983	1083	1123				963	1063	1103			
“100”	1083	1183	1223				1063	1163	1203			

Maximum ODW casing height – Hd 2286 mm

Maximum ODZ casing height – Hd 2267 mm



FLEXI system sold complete with door frame

- **non-standard dimensions are available on request**
- **single-leaf or double-leaf**
- **toplights and sidelights**
- **transparent or white satin tempered glass, optionally LINEA white satin tempered glass, one-sided ornament**

STEEL DOORS

The steel door collection includes unique glazed doors with structural steel muntin bars in the colour of the door leaf and accessories such as handrails or handles.

They are ideally suited for loft or industrial style interiors that need a lot of daylight. They will work perfectly in every interior.





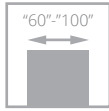

GALIO



GALIO door, S5 pattern, steel angle bar door frame

Interior door for use in public buildings, e.g. including offices, and apartments.
Interior door made in compliance with the PN-EN 14351-2:2 standard.



LINEA tempered glass pane in the colour of white satin, one-sided ornament - at extra charge



hinge



two-sided angle bar shaped handrail



GALIO door, S6 pattern, steel angle bar door frame



VERSION S1 / VS1 S2 / VS2 S3 / VS3 S4 / VS4 S5 / VS5



VERSION S6 / VS6 S7 / VS7 S8 / VS8 S9 / VS9

COLOURS

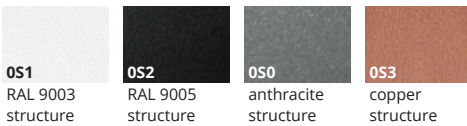

DOOR FRAMES

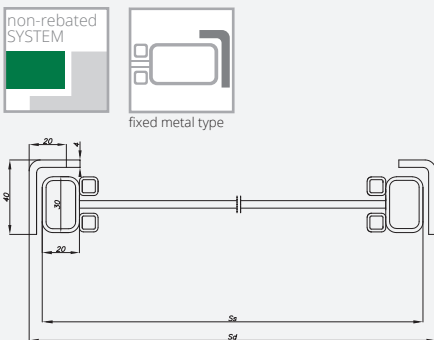

single-leaf door			
type	S _s	S _d	S _o
"60"	625	639	645
"70"	725	739	745
"80"	825	839	845
"90"	925	939	945
"100"	1025	1039	1045
standard – H _s - 2040 mm, H _d - 2057 mm, H _o - 2060 mm			
- 50 mm height – H _s - 1990 mm, H _d - 2007 mm, H _o - 2010 mm			
+ 50 mm height – H _s - 2090 mm, H _d - 2107 mm, H _o - 2110 mm			
+ 100 mm height – H _s - 2140 mm, H _d - 2157 mm, H _o - 2160 mm			

EQUIPMENT

STANDARD
leaf frame made of top-quality powder-coated steel profiles, on-glass metal muntin bars
structural powder paint, structural on-glass metal muntin bars
transparent or white satin 4 mm tempered thick glass
mat glass pane on hinge side
structural 20 mm wide muntin bars
two-sided angle bar shaped handrail in the colour of the leaf
leaf closing magnet
steel angle bar door frame
metal door frame hinges ("60"- "100" - 3 pcs.)
GALIO door maximum height – 2157 mm
ADDITIONAL (available at an extra charge)
colour OS3 copper structure
door higher or lower by 50 mm

door higher or lower up to 50 mm (non-standard dimension)			
door higher by 50-100 mm (non-standard dimension)			
doors with non-standard widths			
LINEA white satin 4 mm tempered thick glass, one-sided ornament			
GALIO colours	colour of hinges	colour of glazing seal (muntin bars)	colour of screws for moulding
OS1 RAL 9003 (white)	in the colour of the door leaf	white	white
OS2 RAL 9005 (black)	in the colour of the door leaf	black	black
OS0 anthracite	in the colour of the door leaf	anthracite	black
OS3 copper	in the colour of the door leaf	black	black

Doors of non-standard dimensions are available upon consultations with the Sales Department.



GALIO

DOUBLE-LEAF DOOR

NEW



GALIO double-leaf door, S2 pattern, steel angle bar door frame

- **symmetrical division of leaves** (asymmetrical division of leaves available on request)
- **double-leaf door with magnetic closing system** in the upper part of the door
- independent **opening of door leaves with two handrails**

NEW



LINEA tempered glass pane in the colour of white satin, one-sided ornament - at extra charge



two-sided angle bar shaped handrail



GALIO double-leaf door, S1 pattern, steel angle bar door frame



VERSION **S1 / VS1** **S2 / VS2** **S3 / VS3** **S4 / VS4** **S5 / VS5**



VERSION **S6 / VS6** **S7 / VS7** **S8 / VS8** **S9 / VS9**

COLOURS

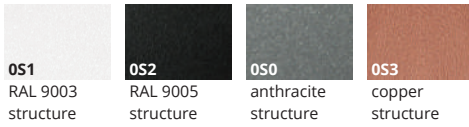

DOOR FRAMES

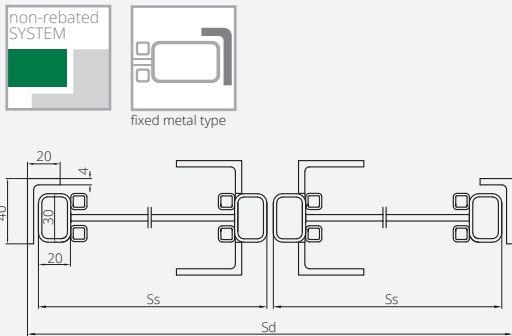

double-leaf door			
type	S _s	S _d	S _o
"60"×"60",	625 + 625	1271	1277
"70"×"70",	725 + 725	1471	1477
"80"×"80",	825 + 825	1671	1677
"90"×"90",	925 + 925	1871	1877
"100"×"100",	1025 + 1025	2071	2077
standard – H _s - 2040 mm, H _d - 2057 mm, H _o - 2060 mm			
- 50 mm height – H _s - 1990 mm, H _d - 2007 mm, H _o - 2010 mm			
+ 50 mm height – H _s - 2090 mm, H _d - 2107 mm, H _o - 2110 mm			
+ 100 mm height – H _s - 2140 mm, H _d - 2157 mm, H _o - 2160 mm			

EQUIPMENT

STANDARD	
leaf frame made of top-quality powder-coated steel profiles, on-glass metal muntin bars	
structural powder paint, structural on-glass metal muntin bars	
transparent or white satin 4 mm tempered thick glass	
mat glass pane on hinge side	
structural 20 mm wide muntin bars	
two-sided angle bar shaped handrail in the colour of the leaf	
leaf closing magnet	
steel angle bar door frame	
metal door frame hinges („60" + „60" - „100" + „100" – 6 pcs)	
GALIO door maximum height – 2157 mm	
ADDITIONAL (available at an extra charge)	
colour 0S3 copper structure	
door higher or lower by 50 mm	without an extra charge
door higher or lower up to 50 mm (non-standard dimension)	

door higher by 50-100 mm (non-standard dimension)			
doors with non-standard widths			
LINEA white satin 4 mm tempered thick glass, one-sided ornament			
GALIO colours	colour of hinges	colour of glazing seal (muntin bars)	colour of screws for moulding
0S1 RAL 9003 (white)	in the colour of the door leaf	white	white
0S2 RAL 9005 (black)	in the colour of the door leaf	black	black
0S0 anthracite	in the colour of the door leaf	anthracite	black
0S3 copper	in the colour of the door leaf	black	black

non-rebated
SYSTEM

"60"- "100"

"120"- "200"



GALIO SIDELIGHTS / TOPLIGHTS

NEW

- **sidelight/toplight frame made of top-quality structural powder-coated steel profiles**
- **20 mm wide structural on-glass muntin bars**
- **transparent or white satin**
4 mm thick **tempered glass**
- sidelight maximum height – 2157 mm
- sidelight/toplight minimum width - 300 mm

GALIO door with sidelight and toplight



GALIO door with sidelights

EXEMPLARY GALIO DOOR AND SIDELIGHT/ TOPLIGHT SETS



SIDELIGHT/TOPLIGHT PRICE = PRICE PER 1 M X 2 (A+B) + PRICE PER 1M² OF GLASS X A X B

SIDELIGHT/TOPLIGHT PRICE PER 1M EXCL. VAT = 60

TRANSPARENT 4 MM THICK TEMPERED GLASS PANE PRICE PER 1 SQ.M. EXCL. VAT = 31

WHITE SATIN 4 MM THICK TEMPERED GLASS PANE PRICE PER 1 SQ.M. EXCL. VAT = 37

A – width; B – height

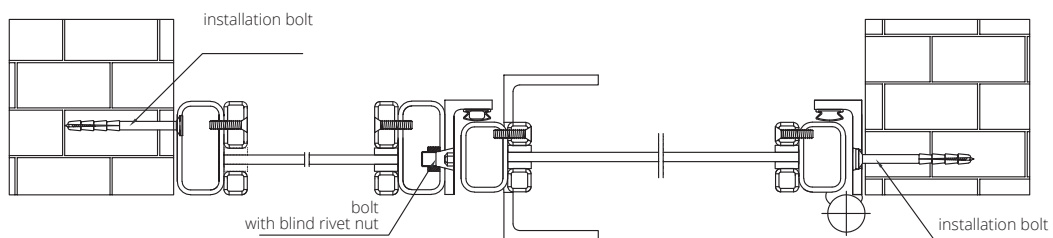
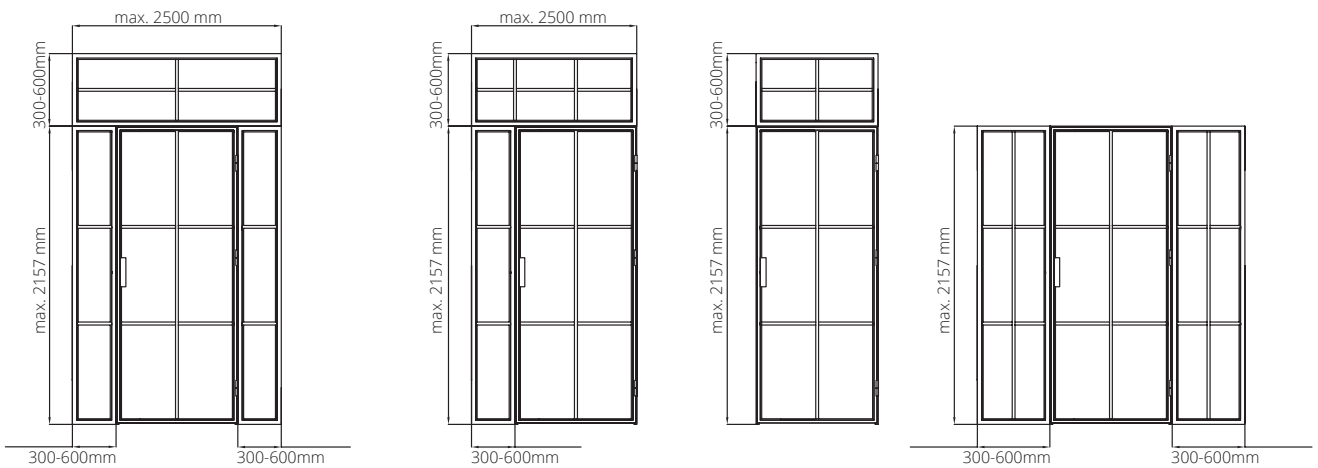

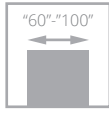

STALIO



STALIO door, S1 pattern, steel angle bar door frame

Interior door for use in public buildings, e.g. including offices, and apartments.
Interior door made in compliance with the PN-EN 14351-2:2 standard.

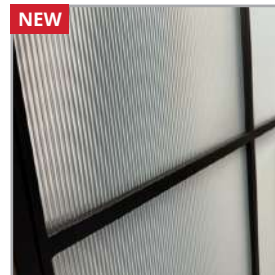

NEW
LINEA tempered glass pane in the colour of white satin, one-sided ornament - at extra charge



hinge



lock with handle



STALIO door, S5 pattern, steel angle bar door frame



VERSION S1 / VS1 S2 / VS2 S3 / VS3 S4 / VS4 S5 / VS5



VERSION S6 / VS6 S7 / VS7 S8 / VS8 S9 / VS9

COLOURS

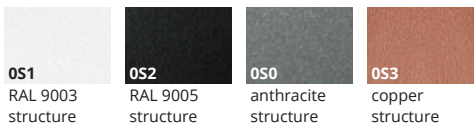

DOOR FRAMES

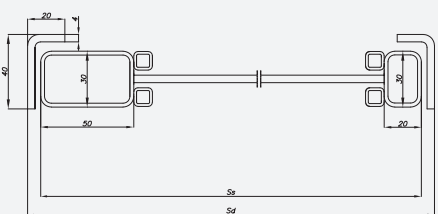

DIMENSIONS

	Ss	Sd	So
width			
"60"	625	643	649
"70"	725	743	749
"80"	825	843	849
"90"	925	943	949
"100"	1025	1043	1049
standard - Hs - 2040 mm, Hd - 2057 mm, Ho - 2060 mm			
- 50 mm height - Hs - 1990 mm, Hd - 2007 mm, Ho - 2010 mm			
+ 50 mm height - Hs - 2090 mm, Hd - 2107 mm, Ho - 2110 mm			
+ 100 mm height - Hs - 2140 mm, Hd - 2157 mm, Ho - 2160 mm			

EQUIPMENT

STANDARD	
leaf frame made of top-quality powder-coated steel profiles, on-glass metal muntin bars	
structural powder paint, structural on-glass metal muntin bars	
transparent or white satin 4 mm tempered thick glass	
mat glass pane on hinge side	
structural 20 mm wide muntin bars	
lock with handle	
steel angle bar door frame	
metal door frame hinges ("60"- "100" - 3 pcs.)	
STALIO door maximum height - 2157 mm	
ADDITIONAL (available at an extra charge)	
colour OS3 copper structure	
silver colour cylinder	
door higher or lower by 50 mm	without an extra charge
door higher or lower up to 50 mm (non-standard dimension)	

door higher by 50-100 mm (non-standard dimension)					
doors with non-standard widths					
LINEA white satin 4 mm tempered thick glass, one-sided ornament					
STALIO colours	colour of hinges	colour of glazing seal (muntin bars)	colour of handle	colour of lock plate	colour of screws for moulding
OS1 RAL 9003 (white)	in the colour of the door leaf	white	white	silver	white
OS2 RAL 9005 (black)	in the colour of the door leaf	black	black	black	black
OS0 anthracite	in the colour of the door leaf	anthracite	black	black	black
OS3 copper	in the colour of the door leaf	black	black	black	black

- **modern or classic**
- **wide range of available colours, laminated surfaces and veneers**
- **rich palette of RAL and NCS colours**
- **wooden, panelled or rail and stile**
- **rebated, hidden, non-rebated, reverse rebate, sliding systems**

INTERIOR DOOR

Interior doors are manufactured based on high quality structures and infills, which is why they fulfil the requirements of Customers and suit their needs. Fancy a classic door or a modern door? Our range of interior doors comprises over 450 door designs, including stylish profiled doors, plain doors, glazed or decorated doors.





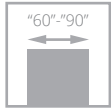

for door leaves with ventilation option



MODESTO door, W03 pattern, DIN SYSTEM adjustable door frame

MODESTO

NEW

NEW COLOURS

- robust structure based on **wooden frame**
- 3-layered **painting system – colour fastness** for many years
- panel thickness: 12 mm
- wide range of **RAL and NCS colours**
- adjustable type K, type C and adjustable type DUO hinge



milled pattern on the door leaf surface



INTERIOR DOORS | RAIL AND STILE TYPE | PAINTED



MODESTO door, W04 pattern, DIN adjustable door frame



VERSION **W00** **W01** **W02** **W03** **W04**

WHITE
GREY, BEIGE
BLACK, SAGE

COLOURS



OPTIONAL COLOURS

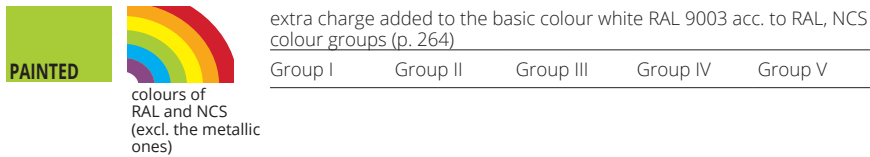

DOOR FRAMES

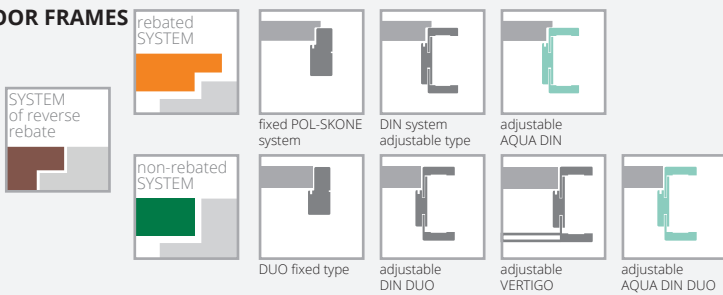

EQUIPMENT

STANDARD		
single-point lock, spacing: 72 mm (rebated sys.) or magnetic (non-rebated sys.) mortise key-operated lock (spacing: 90 mm), for cylinder (spacing: 85 mm) or bathroom privacy lock (spacing: 90 mm)		change of standard DUO hinge to the colour of white or black (for 1 piece)
hinges: type K – for DIN system door frame, type C – for wooden door frame or hidden DUO nickel satin ("60"- "80" – 2 pcs, "90" – 3 pcs)		ventilation undercut
not available with a door closer		bottom rail and stile set protected against excessive moisture (except door leaves with ventilation undercut)
ADDITIONAL (available at an extra charge)		door lower by 50 mm or 100 mm (rebated sys.)
size "100"	+10%	without an extra charge
REVES system (reversed rebate)		door lower by 55 mm or 100 mm (non-rebated sys.)
recuperation trim	without an extra charge	without an extra charge
third hinge in the door leaf:		door higher by 50 mm or 100 mm (third hinge required for an extra charge)
type C for a width of "60"- "80"		+10%
type K for width "60"- "80"		door higher by 150 mm or 200 mm (third hinge required for an extra charge)
hidden DUO for a width of "60"- "80"		+20%

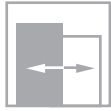
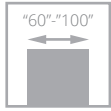

VILANO

NEW COLOURS



- **robust wooden frame structure**
- **3-layered painting system** - colour fastness for many years
- wide range of **RAL and NCS colours**
- **safe 6 mm thick tempered glass pane** in the colour of white matt
- adjustable type K, type C and adjustable type DUO hinge



VILANO door, W00 pattern, DIN adjustable door frame

DUO hidden hinge, white – optional for non-rebated sys.

moulding profile



INTERIOR DOORS | RAIL AND STILE TYPE | PAINTED



VILANO door, W00 pattern, DIN adjustable door frame



VERSION **W00 / V01** **OSD / V1SD**

WHITE
GREY, BEIGE
BLACK, SAGE

COLOURS



Only applicable to Vilano W00 door leaf and DIN, DIN DUO and Vertigo door frames.

OPTIONAL COLOURS



extra charge added to the basic white colour, RAL 9003 acc. to RAL, NCS colour groups (p. 264)

Group I	Group II	Group III	Group IV	Group V
---------	----------	-----------	----------	---------

DOOR FRAMES

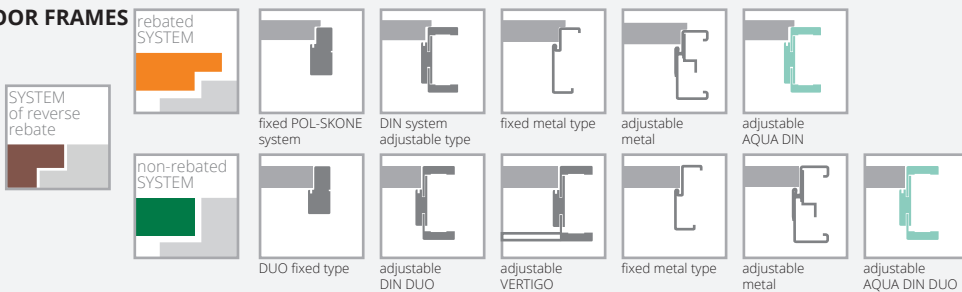

EQUIPMENT

STANDARD	rebated system, collection BLACK: lock colour change to black bottom rail and stile set protector against excessive moisture impact (except door leaves with ventilation undercut) door lower by 50 mm (rebated sys.) door lower by 55 mm (non-rebated sys.) door higher by 50 mm or 100 mm (third hinge required for an extra charge) door higher by 150 mm or 200 mm (third hinge required for an extra charge) recuperation trim REVES system (reversed rebate) (version W00) (above the ZW4 range, the door opening angle is 88°) third hinge in the door leaf: type M for width "60"-80" type C for a width of "60"-80" type K for width "60"-80" concealed DUO type for a width of "60"-80" change of standard DUO hinge to the colour of white or black (for 1 piece)	without an extra charge without an extra charge without an extra charge without an extra charge +10% +20% without an extra charge without an extra charge ventilation undercut (p. 245)
ADDITIONAL (available at an extra charge)	size "100" +20% without an extra charge	

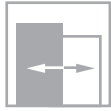
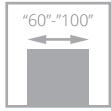

VERTIGO

NEW COLOURS



- **robust wooden frame structure**
- **3-layered painting system** - colour fastness for many years
- wide range of **RAL and NCS colours**
- **safe 6 mm thick tempered glass pane** in the colour of white matt
- adjustable type K, type C and adjustable type DUO hinge



VERTIGO door, W03 pattern, DIN SYSTEM adjustable door frame



moulding



DUO hidden hinge, white - optional for non-rebated sys.



architraves connected in a standard way at an angle of 45° for the DIN DUO door frame



INTERIOR DOORS RAIL AND STILE TYPE PAINTED



VERTIGO door, W02 pattern, SYSTEM VERTIGO adjustable door frame



VERSION **W00 / V01** **OSD / V1SD** **W02 / V02** **W02S1 / V2SD**

WHITE
GREY, BEIGE
BLACK, SAGE



VERSION **W03 / V03** **W03S1 / V3S1** **W03S2 / V3S2** **W03S3 / V3S3**

WHITE
GREY, BEIGE
BLACK, SAGE

COLOURS



Only applicable to Vertigo W00, W02, W03 door leaves and DIN, DIN DUO and Vertigo door frames.

OPTIONAL COLOURS



RAL and NCS colours (excluding metallic ones)

extra charge added to the basic colour white RAL 9003 acc. to RAL, NCS colour groups (p. 264)

Group I	Group II	Group III	Group IV	Group V
---------	----------	-----------	----------	---------

DOOR FRAMES

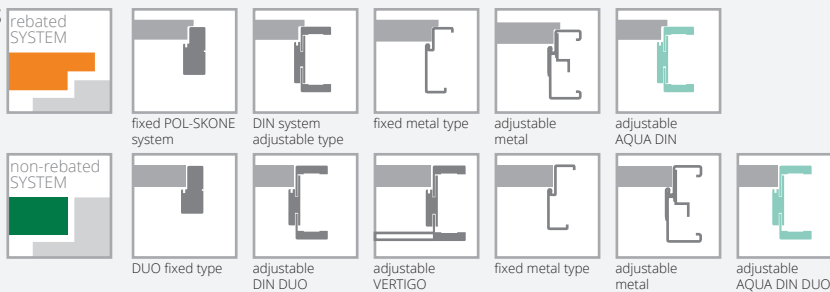

EQUIPMENT

STANDARD		
white matt 6 mm thick tempered glass transparent pane cannot be used		third hinge in the door leaf:
single-point lock, spacing: 72 mm (rebated sys.) or magnetic (non-rebated sys.)		type C for width "60"- "80"
mortise lock, for key (spacing: 90 mm), for cylinder (spacing: 85 mm) or for bathroom privacy lock (spacing: 90 mm)		type K for width "60"- "80"
hinges: type K - for DIN system door frame, type C - for wooden door frame, type M - for metal door frame or hidden DUO nickel satin ("60"- "80" - 2 pcs, "90" - 3 pcs)		type M for width "60"- "80"
not available with a door closer		concealed DUO type for width "60"- "80"
collection BLACK: standard magnetic lock face plate and DUO hinges are in the colour of black		change of standard DUO hinge to the colour of white or black (for 1 piece)
ADDITIONAL (available at an extra charge)		rebated system, collection BLACK: lock colour change to black
size "100"	+20%	without an extra charge
recuperation trim	without an extra charge	bottom rail and stile set protector against excessive moisture impact (except door leaves with ventilation undercut)
REVES system (reversed rebate) (versions: W00, W02, W03) (above the ZW5 range, the door opening angle is 87°)		door lower by 50 mm (rebated sys.)
		without an extra charge
		door lower by 55 mm (non-rebated sys.)
		without an extra charge
		door higher by 50 mm or 100 mm (third hinge required at an extra charge)
		+10%
		door higher by 150 mm or 200 mm (third hinge required at an extra charge)
		+20%
		ventilation undercut (p. 245)

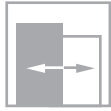
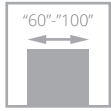

for door leaves with ventilation option



MODERN door, 02 pattern, DIN SYSTEM adjustable door frame

MODERN

NEW COLOURS



- **robust wooden frame structure**
- **3-layered painting system** - colour fastness for many years
- wide range of **RAL and NCS colours**
- adjustable type K, type C and adjustable type DUO hinge



door leaf rail and stile profile



DUO hidden hinge, white – optional for non-rebated sys.



painted architrave and crown



INTERIOR DOORS | RAIL AND STILE TYPE | PAINTED



MODERN door, 02 pattern with crown, DIN SYSTEM adjustable door frame



VERSION **01 / V01** **01S6 / V1S6** **02 / V02** **02S6 / V2S6**

WHITE
GREY, BEIGE
BLACK, SAGE



VERSION **05 / V05** **05S8 / V5S8** **08 / V08** **08S10 / V8S10**

WHITE
GREY, BEIGE
BLACK, SAGE

COLOURS



OPTIONAL COLOURS



extra charge added to the basic white colour, RAL 9003 acc. to RAL, NCS colour groups (p. 264)

Group I Group II Group III Group IV Group V

Only applicable to Modern 01, 02, 05, 08 door leaves and DIN, DIN DUO and Vertigo door frames.

DOOR FRAMES

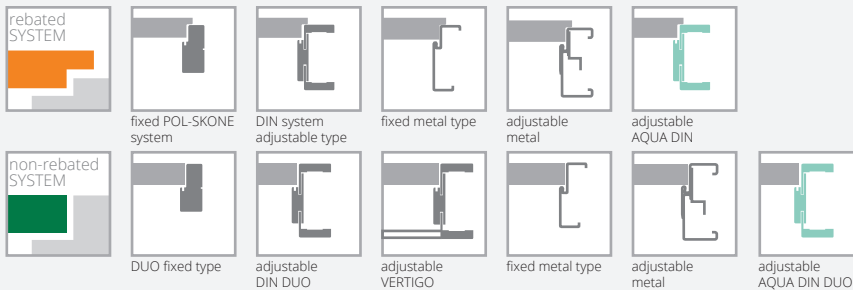

EQUIPMENT

STANDARD	
white matt or transparent 4 mm thick glass	
wooden muntins	
single-point lock, spacing: 72 mm (rebated sys.) or magnetic (non-rebated sys.)	
mortise lock, for key (spacing: 90 mm), for cylinder (spacing: 85 mm) or for bathroom privacy lock (spacing: 90 mm)	
hinges: type K - for DIN system door frame, type C - for wooden door frame, type M - for metal door frame or hidden DUO nickel satin ("60"-80" - 2 pcs, "90" - 3 pcs)	
not available with a door closer	
Collection BLACK: standard face plate of magnetic lock and DUO hinges in the colour of black	
ADDITIONAL (available at an extra charge)	
size "100"	+20%
recuperation trim	without an extra charge
REVES (reversed rebate) system (version 01, 02, 05, 08)	

third hinge in the door leaf:	
type C for width "60"-80"	
type K for width "60"-80"	
type M for width "60"-80"	
concealed DUO type for width "60"-80"	
change of standard DUO hinge to the colour of white or black (for 1 piece)	
rebated system, collection BLACK:	without an extra charge
lock colour change to black	
bottom rail and stile set protector against excessive moisture impact (except door leaves with ventilation undercut)	
door lower by 50 mm (rebated sys.)	without an extra charge
door lower by 55 mm (non-rebated sys.)	without an extra charge
door higher by 50 mm or 100 mm (third hinge required at an extra charge)	+10%
door higher by 150 mm or 200 mm (third hinge required at an extra charge)	+20%
ventilation undercut (p. 245)	

MODENA

NEW
COLOURS

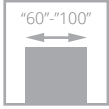

for door leaves with ventilation option



MODENA door, W02 pattern, DIN SYSTEM adjustable door frame

- **robust wooden frame structure**
- **3-layered painting system** - colour fastness for many years
- wide range of **RAL and NCS colours**
- adjustable type K, type C and adjustable type DUO hinge



door leaf rail and stile profile



INTERIOR DOORS | RAIL AND STILE TYPE | PAINTED



MODENA door, 08 pattern, DIN adjustable door frame



VERSION **02 / V02** **05 / V05** **08 / V08**

WHITE
GREY, BEIGE
BLACK, SAGE

COLOURS



001
white
(RAL 9003)



0M5
grey **matt**
(RAL 7047)

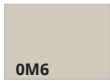

0M6
beige **matt**
(NCS S 2005 Y50R)



BLACK



002
black
(RAL 9005)



NEW
0M7
sage **matt**
(NCS S 4010-G50Y)

Only applicable to DIN, DIN DUO and Vertigo door frames.

OPTIONAL COLOURS



colours of
RAL and NCS
(excl. the metallic
ones)

extra charge added to the basic white colour, RAL 9003
acc. to RAL, NCS colour groups (p. 264)

Group I Group II Group III Group IV Group V

DOOR FRAMES



fixed system
POL-SKONE

DUO fixed type



adjustable
DIN system

adjustable
DIN DUO



adjustable
AQUA DIN

adjustable
VERTIGO

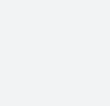

adjustable
AQUA DIN DUO

EQUIPMENT

STANDARD	
single-point lock, spacing: 72 mm (rebated sys.) or magnetic (non-rebated sys.) mortise key-operated lock (spacing: 90 mm), for cylinder (spacing: 85 mm) or bathroom privacy lock (spacing: 90 mm)	
hinges: type K - for DIN system door frame, type C - for wooden door frame or hidden DUO nickel satin ("60"-80" - 2 pcs, "90" - 3 pcs)	
not available with a door closer	
ADDITIONAL (available at an extra charge)	
size "100"	+10%
REVES system (reversed rebate)	
recuperation trim	without an extra charge
third hinge in the door leaf: type C for a width of "60"-80" type K for width "60"-80"	
concealed DUO type for width "60"-80"	

change of standard DUO hinge to the colour of white or black (for 1 piece)	
ventilation undercut (p. 245)	
bottom rail and stile set protected against excessive moisture (except door leaves with ventilation undercut)	
door lower by 50 mm or 100 mm (rebated sys.)	without an extra charge
door lower by 55 mm or 100 mm (non-rebated sys.)	without an extra charge
door higher by 50 mm or 100 mm (required third hinge available at an extra charge)	+10%
door higher by 150 mm or 200 mm (third hinge required at an extra charge)	+20%

PALAZZO

NEW
COLOURS

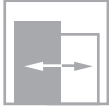
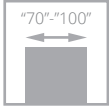

for door leaves
with ventilation
option



- **robust wooden** frame structure
- **unique** patterns
- rebated **or** non-rebated **system**
- **3-layered painting system** - colour fastness for many years
- **rich choice of colours** – standard: white, matt grey and matt beige, optionally: black
- **adjustable TYPE K hinge** for rebated door or **adjustable type DUO hinge** for non-rebated door



PALAZZO door, W00 pattern, DIN SYSTEM adjustable door frame, RAL 5014 matt

door leaf rail and stile profile



INTERIOR DOORS | RAIL AND STILE TYPE | PAINTED



PALAZZO door, W00 pattern, DIN adjustable door frame



VERSION W00

WHITE
GREY, BEIGE
BLACK, SAGE

COLOURS



Only applicable to DIN, DIN DUO and Vertigo door frames

OPTIONAL COLOURS



RAL and NCS colours (excluding metallic ones)

extra charge added to the basic white colour, RAL 9003 acc. to RAL, NCS colour groups (p. 264)

Group I Group II Group III Group IV Group V

DOOR FRAMES



EQUIPMENT

STANDARD	single-point lock, spacing: 72 mm (rebated sys.) or magnetic (non-rebated sys.) mortise key-operated lock (spacing: 90 mm), for cylinder (spacing: 85 mm) or bathroom privacy lock (spacing: 90 mm)
	hinges: type K – for DIN system door frame, type C – for wooden door frame or hidden DUO nickel satin ("70" – 2 pcs, "80" – "90" – 3 pcs)
	not available with a door closer
ADDITIONAL (available at an extra charge)	size "100"
	REVES system (reversed rebate)
	recuperation trim

third hinge in the door leaf: type C for a width of "70"- "80" type K for width "70"- "80" concealed DUO type for width "70"	
change of standard DUO hinge to the colour of white or black (for 1 piece)	
ventilation undercut	
bottom rail and stile set protected against excessive moisture (except door leaves with ventilation undercut)	
door lower by 50 mm or 100 mm (rebated sys.)	without an extra charge
door lower by 55 mm or 100 mm (non-rebated sys.)	without an extra charge
door higher by 50 mm or 100 mm	+10%

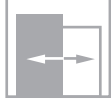
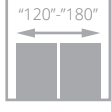
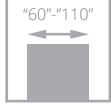

Class II



CAMBIO door, 00 pattern, DIN SYSTEM adjustable door frame

CAMBIO



- **robust structure - wooden rail and stile set**
- **3-layered painting system** - colour fastness for many years
- wide range of **RAL and NCS colours**
- **adjustable type K, type C hinge and adjustable type DUO hinge**



hidden DUO black hinge – standard for non-rebated sys., collection BLACK



DUO hidden hinge, white – optional for non-rebated sys.



laminated door leaf edge in the colour of black, graphite or grey - option (except the BLACK surface)



CAMBIO door, 00 pattern, DIN SYSTEM DUO door frame





VERSION **00 / V00** **02 / V2S** **03SD / V3SD** **04 / V4SD** **05 / V5SD**

WHITE
GREY, BEIGE
BLACK, SAGE

COLOURS



Only applicable to Cambio door leaves and DIN, DIN DUO and Vertigo door frames.

OPTIONAL COLOURS



extra charge added to the basic white colour, RAL 9003
acc. to RAL, NCS colour groups (p. 264)

Group I	Group II	Group III	Group IV	Group V
---------	----------	-----------	----------	---------

DOOR FRAMES

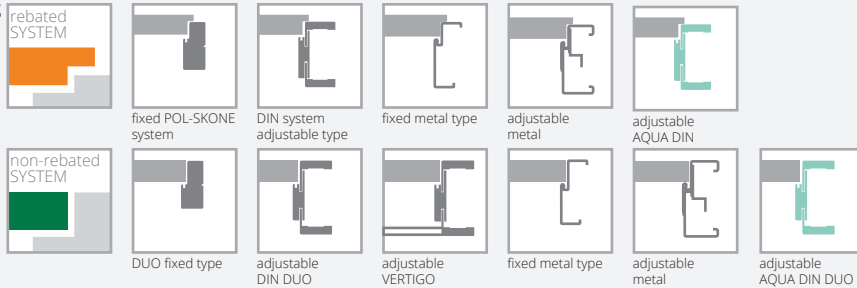

EQUIPMENT

STANDARD	
white matt or transparent 4 mm thick glass	
version 03SD: white matt tempered glass	
single-point lock, spacing: 72 mm (rebated sys.) or magnetic (non-rebated sys.) mortise lock, for key (spacing: 90 mm), for cylinder (spacing: 85 mm) or for bathroom privacy lock (spacing: 90 mm)	
hinges: type K, silver - for DIN system door frame, type C, silver - for wooden door frame, type M - for metal door frame or hidden DUO nickel satin ("60"- "80" - 2 pcs, "90" - 3 pcs)	
for a leaf with a door closer and DIN or metal frame, use type T hinges in the quantity of "60"- "80" - 3 pieces, "90"- "110" - 4 pcs. (replacement of standard hinges for type T hinge for an extra charge)	
collection BLACK: standard magnetic lock face plate and DUO hinges are in the colour of black	
ADDITIONAL (available at an extra charge)	
size "100" (glazing decoration as in "90")	+10%
size "110" (glazing decoration as in "90")	+20%
REVES (reversed rebate) system (version 00)	
recuperation trim	without an extra charge
perforated chipboard in-fill	
solid chipboard in-fill (third hinge recommended)	
third hinge in the door leaf or adjustable pivot hinge (1 piece price):	
type M for width "60"- "80"	
type C for width "60"- "80"	
type K for width "60"- "80"	
concealed DUO type for width "60"- "80"	
change of standard DUO hinge to the colour of white or black (for 1 piece)	
change of the DUO lock colour to black or golden gloss	
rebated system, collection BLACK:	without an extra charge
lock colour change to black	
rail and stile set (for do-it-yourself shortening to 50 mm)	
rail and stile set (for do-it-yourself shortening to 90 mm)	
reinforcement for door closer	
bottom rail and stile set protector against excessive moisture (except door leaves with ventilation undercut)	
door lower by 50 mm or 100 mm (rebated sys.)	without an extra charge
door lower by 55 mm or 100 mm (non-rebated sys.)	without an extra charge
door higher by 50 mm or 100 mm (third hinge required at an extra charge)	+10%
door higher by 150 mm or 200 mm (third hinge required at an extra charge)	+20%
ventilation undercut (p. 245)	
tempered glass:	
version 02, 04, 05	
door leaf edge in the colour of black, grey or graphite (except the REVES system)	without an extra charge
transparent 4 mm thick tempered glass	+10%

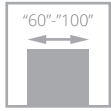

ESTATO door, A02 pattern, DIN SYSTEM adjustable door frame

ESTATO



- **robust structure - wooden rail and stile set**
- stable in-fill **made of perforated board**
- **3-layered painting system** - colour fastness for many years
- wide range of **RAL and NCS colours**
- **safe 6 mm thick tempered glass pane** in the colour of white matt or **laminated VSG 44.2 glass pane in the colour of black or white**
- **reinforced type T, C hinge and adjustable type DUO hinge**



milled pattern on the door leaf surface



laminated glass pane in the colour of white matt



laminated door leaf edge in the colour of black, graphite or grey - option (except the BLACK surface)



pane in the colour of black - optional



ESTATO door, A01 pattern, DIN SYSTEM adjustable door frame



WHITE MATT TEMPERED GLASS PANE

VERSION A01 / V1SA A02 / V2SA A03 / V3SA B1 / VF11 B2 / VF12 B3 / VF13

WHITE
GREY, BEIGE



LAMINATED BLACK GLASS PANE

LAMINATED WHITE MATT GLASS PANE

VERSION A01 / V1SA A02 / V2SA A03 / V3SA A01 / V1SA A02 / V2SA A03 / V3SA

WHITE
GREY, BEIGE

COLOURS

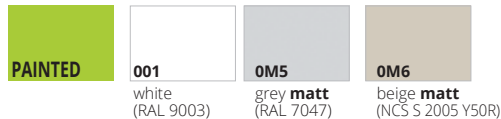

OPTIONAL COLOURS

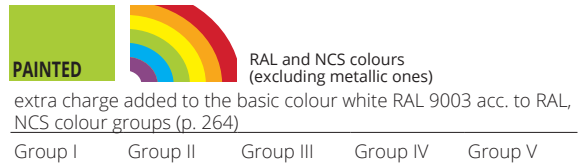

Group I Group II Group III Group IV Group V

DOOR FRAMES

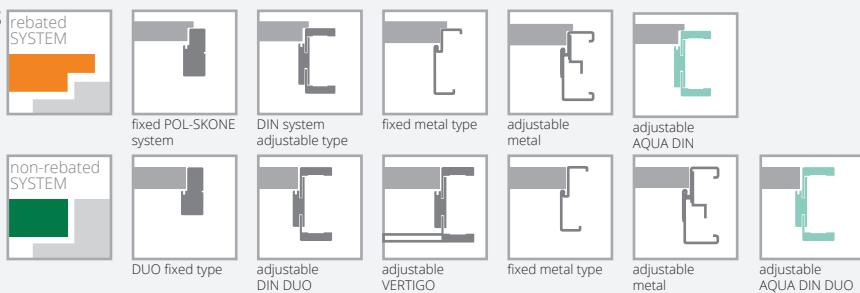

EQUIPMENT

STANDARD		
white matt 6 mm tempered thick glass (patterns: A01-58 mm, A02-208 mm, A03-280 mm)*		reinforcement for a door closer (except versions A01, A02, A03)
laminated 44.2 glass, 8.5 mm thick, in the colour of black or white matt (patterns: A01-54 mm, A02-205 mm, A03-276 mm)		bottom rail and stile set protector against excessive moisture (except door leaves with ventilation undercut) (except versions A01, A02, A03)
single-point lock, spacing: 72 mm (rebated sys.) or magnetic (non-rebated sys.)		door lower by 50 mm or 100 mm (rebated sys.) without an extra charge
mortise lock, for key (spacing: 90 mm), for cylinder (spacing: 85 mm) or for bathroom privacy lock (spacing: 90 mm)		(except versions A01, A02, A03)
hinges: type T - for DIN system door frame, type C - for wooden door frame, („60“-„80“ - 2 pcs, „90“ - 3 pcs) or hidden DUO nickel satin for non-rebated system (“60“-„70“ - 2 pcs, “80“ - “90“ - 3 pcs)		door lower by 55 mm or 100 mm (non-rebated sys.) without an extra charge
ADDITIONAL (available at an extra charge)		(except versions A01, A02, A03)
size "100"	+20%	door higher by 50 mm or 100 mm (third hinge available at an extra charge) (except versions A01, A02, A03) +10%
REVES system (reversed rebate)		door higher by 150 mm or 200 mm (third hinge available at an extra charge) (except versions A01, A02, A03) +20%
solid chipboard in-fill (third hinge recommended)		versions A01, A02, A03 door lower by 50 mm (rebated sys.) without an extra charge
third hinge in the door leaf:		versions A01, A02, A03 door lower by 55 mm (non-rebated sys.) without an extra charge
type C for width "60"-„80"		versions A01, A02, A03 door higher by 100 mm (third hinge available at an extra charge) +10%
type T for a width of "60"-„80"		versions A01, A02, A03 door higher by 200 mm (third hinge available at an extra charge) +20%
concealed DUO type for width "60"-„70"		ventilation undercut (versions B1, B2, B3 only) (p. 245)
change of standard DUO hinge to the colour of white or black (for 1 piece)		ventilation undercut A01 with widths "60" - "100" (p. 245)
rebated system, collection BLACK:		ventilation undercut A02, A03 with widths "70" - "100" (p. 245)
change of type T hinge to the colour of black (for 1 piece)	without an extra charge	6 mm tempered glass pane in the colour of graphite, brown +10%
lock colour change to black		sliding system (except version A01) p. 238-243
frame (for do-it-yourself shortening of the door leaf up to 50 mm) (except versions A01, A02, A03)		door leaf edge in the colour of black, grey or graphite without an extra charge
frame (for do-it-yourself shortening of the door leaf up to 90 mm) (except versions A01, A02, A03)		(except the REVES system)

*dimension tolerance +/- 2 mm

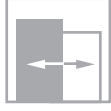
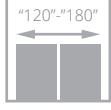
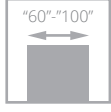

TIARA door, W02 pattern, RAL 5011, DIN SYSTEM adjustable door frame

TIARA

NEW PATTERNS

NEW COLOURS



- **robust structure - wooden rail and stile set**
- stable **solid board in-fill**
- **3-layered painting system** - colour fastness for many years
- wide range of **RAL and NCS colours**
- **adjustable type K, type C hinge and adjustable type DUO hinge**



aluminium decors on the leaf surface in the colour of matt chrome (standard)



DUO hidden hinge, white - optional for non-rebated sys.

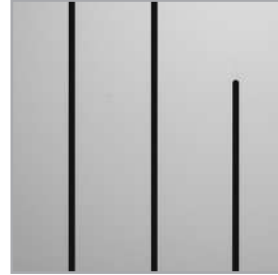

aluminium decors on the leaf surface in the colour of black, golden gloss, chrome gloss



hidden DUO black hinge - standard for non-rebated sys., collection BLACK



TIARA door, W02 pattern, DIN DUO adjustable door frame





VERSION
 WHITE
 GREY, BEIGE
 BLACK, SAGE



VERSION
 WHITE
 GREY, BEIGE
 BLACK, SAGE



laminated door leaf edge in the colour of black, graphite or grey - option (except the BLACK surface)

COLOURS



OPTIONAL COLOURS



extra charge added to the basic white colour, RAL 9003 acc. to RAL, NCS colour groups (p. 264)

Group I	Group II	Group III	Group IV	Group V
---------	----------	-----------	----------	---------

Only applicable to Tiara door leaves and DIN, DIN DUO and Vertigo door frames.

DOOR FRAMES

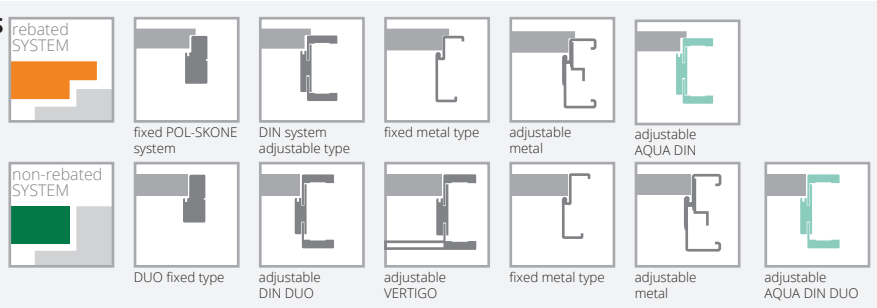

EQUIPMENT

STANDARD	change of standard DUO hinge to the colour of white or black (for 1 piece)	
single-point lock, spacing: 72 mm (rebated sys.) or magnetic (non-rebated sys.) mortise lock, for key (spacing: 90 mm), for cylinder (spacing: 85 mm) or for bathroom privacy lock (spacing: 90 mm)	change of the DUO lock colour to black or golden gloss	
hinges: type K, silver - for DIN system door frame, type C, silver - for wooden door frame, type M - for metal door frame or hidden DUO nickel satin ("60"- "70" - 2 pcs, "80" - "90" - 3 pcs)	rebated system, collection BLACK: lock colour change to black	without an extra charge
collection BLACK: standard magnetic lock face plate and DUO hinges are in the colour of black	rail and stile set (for do-it-yourself shortening to 50 mm) (except patterns W08, W09, W10, W11)	
patterns W09, W10, W11, aluminium decors, 25 mm and 10 mm wide, in the colour of chrome matt, black matt, copper matt	rail and stile set (for do-it-yourself shortening to 90 mm) (except patterns W08, W09, W10, W11)	
patterns W08, W09, W10, W11: ventilation slot or ventilation grill cannot be provided	bottom rail and stile set protector against excessive moisture (except door leaves with ventilation undercut)	
ADDITIONAL (available at an extra charge)	door lower by 50 mm or 100 mm (rebated sys.)	without an extra charge
size "100"	door lower by 55 mm or 100 mm (non-rebated sys.)	without an extra charge
REVES system (reversed rebate)	door higher by 50 mm or 100 mm (third hinge required at an extra charge)	+10%
recuperation trim	door higher by 150 mm or 200 mm (third hinge required at an extra charge)	+20%
third hinge in the door leaf: type C for width "60"- "80" type K for width "60"- "80" type M for width "60"- "80" concealed DUO type for width "60"- "70"	ventilation undercut (p. 245)	
	door leaf edge in the colour of black, grey or graphite (except the REVES system)	without an extra charge

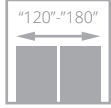
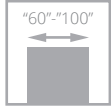

SUBLIME

NEW COLOURS



- **robust structure - wooden rail and stile set**
- stable in-fill **made of perforated board**
- **3-layered painting system** - colour fastness for many years
- wide range of **RAL and NCS colours**
- **reinforced type T, C hinge and adjustable type DUO hinge**



milling on the door leaf surface, 30 mm wide, on pattern B9



milling on the door leaf surface, 15 mm wide, on pattern B12



milling on the door leaf surface, 6 mm wide, on patterns A1-A3 and B2-B6



laminated door leaf edge in the colour of black, graphite or grey - option (except the BLACK surface)

SUBLIME door, B12 pattern, DIN SYSTEM adjustable door frame

INTERIOR DOORS **PAINTED**



SUBLIME door, B12 pattern, DIN SYSTEM adjustable door frame

REBATED SYSTEM



VERSION **A0 / V00** **A1 / VF1** **A2 / VF2** **A3 / VF3** **B2 / VF4** **B4 / VF5** **B6 / VF6** **B9 / VF7** **B12 / VF8**

WHITE
GREY, BEIGE
BLACK, SAGE

COLOURS

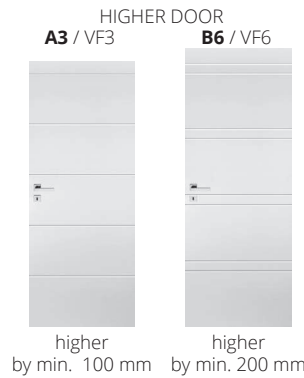
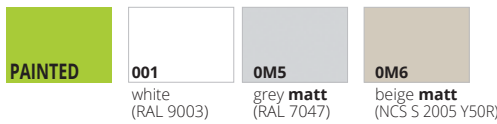

OPTIONAL COLOURS



Only applicable to Sublime door leaves and DIN, DIN DUO and Vertigo door frames.

extra charge added to the basic white colour, RAL 9003 acc. to RAL, NCS colour groups (p. 264)

Group I Group II Group III Group IV Group V

DOOR FRAMES

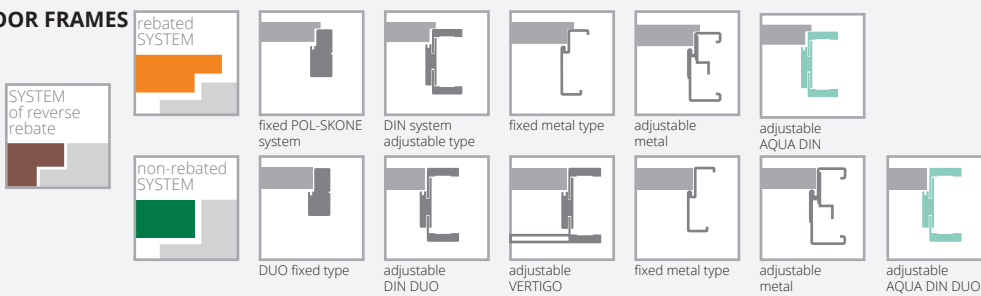

EQUIPMENT

STANDARD		
single-point lock, spacing: 72 mm (rebated sys.) or magnetic (non-rebated sys.)		change of the DUO lock colour to black or golden gloss
mortise lock, for key (spacing: 90 mm), for cylinder (spacing: 85 mm) or for bathroom privacy lock (spacing: 90 mm)		rebated system, collection BLACK: change of type T hinge to the colour of black (for 1 piece) without an extra charge
silver hinges: type T – for the DIN system door frame and the metal door frame, type C – for the wooden door frame, ("60"- "80" – 2 pcs, "90" – 3 pcs) or hidden DUO nickel satin ("60"- "70" – 2 pcs, "80" – "90" – 3 pcs)		lock colour change to black without an extra charge
door higher than standard – non-standard milling location		rail and stile set (for do-it-yourself shortening of the door leaf by max. 50 mm on a do-it-yourself basis)
collection BLACK: standard face plate of magnetic lock and DUO hinges in the colour of black		rail and stile set (for do-it-yourself shortening of the door leaf by max. 90 mm on a do-it-yourself basis)
patterns B9 wider milling, patterns B12, A1-A3, B2-B6 narrower milling		reinforcement for door closer
ADDITIONAL (available at an extra charge)		ventilation undercut (p. 245)
size "100"	+20%	bottom rail and stile set protector against excessive moisture (except door leaves with ventilation undercut)
REVES (reverse rebate) system		door lower by 50 mm or 100 mm (rebated sys.) without an extra charge
recuperation trim	without an extra charge	door lower by 55 mm or 100 mm (non-rebated sys.) without an extra charge
solid chipboard in-fill (third hinge recommended)		door higher by 50 mm or 100 mm (third hinge required at an extra charge) +10%
third hinge in the door leaf:		door higher by 150 mm or 200 mm (third hinge required at an extra charge) +20%
type C for width "60"- "80"		door leaf edge in the colour of black, grey or graphite without an extra charge
type T for a width of "60"- "80"		(except the REVES system)
concealed DUO type for width "60"- "70"		
change of standard DUO hinge to the colour of white or black (for 1 piece)		

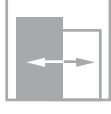
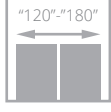
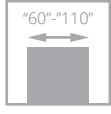

SUBITO door, 07 pattern, DIN SYSTEM adjustable door frame

SUBITO



- **robust structure - wooden rail and stile set**
- **3-layered painting system** - colour fastness for many years
- wide range of **RAL and NCS colours**
- **adjustable** type K, type C hinge and adjustable type DUO hinge



laminated door leaf edge in the colour of black, graphite or grey - option (except the BLACK surface)



SUBITO door, 07 pattern, DIN SYSTEM adjustable door frame

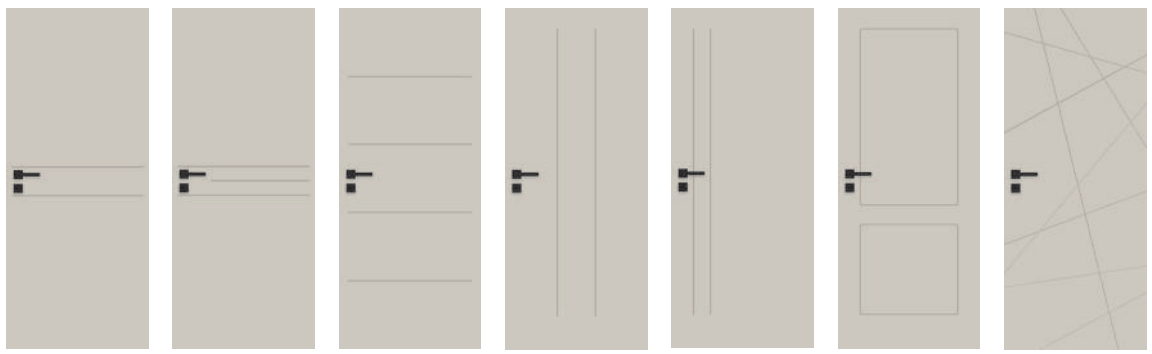

VERSION **01 / VF1** **02 / VF2** **03 / VF3** **04 / VF14** **05 / VF15** **06 / VF9** **07 / VF16**

WHITE
GREY, BEIGE
BLACK, SAGE

COLOURS



Only applicable to Subito door leaves and DIN, DIN DUO and Vertigo door frames.

OPTIONAL COLOURS



extra charge added to the basic white colour, RAL 9003 acc. to RAL, NCS colour groups (p. 264)

Group I	Group II	Group III	Group IV	Group V
---------	----------	-----------	----------	---------

DOOR FRAMES

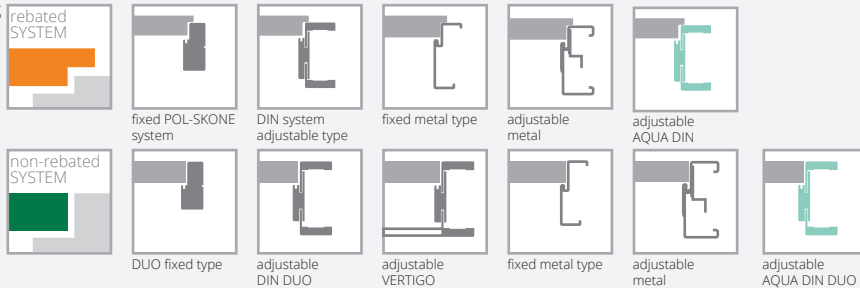

EQUIPMENT

STANDARD	
single-point lock, spacing: 72 mm (rebated sys.) or magnetic (non-rebated sys.) mortise lock, for key (spacing: 90 mm), for cylinder (spacing: 85 mm) or for bathroom privacy lock (spacing: 90 mm)	third hinge in the door leaf or adjustable pivot hinge (1 piece price): type M for width "60"- "80" type C for width "60"- "80" type K for width "60"- "80"
hinges: type K, silver - for DIN system door frame, type C, silver - for wooden door frame, type M - for metal door frame or hidden DUO nickel satin ("60"- "80" - 2 pcs, "90" - 3 pcs)	concealed DUO type for width "60"- "80" change of standard DUO hinge to the colour of white or black (for 1 piece)
for a leaf with a door closer and DIN or metal frame, use type T hinges in the quantity of "60"- "80" - 3 pieces, "90"- "110" - 4 pcs. (replacement of standard hinges for type T hinge for an extra charge)	rebated system, collection BLACK: lock colour change to black
collection BLACK: standard face plate of magnetic lock and DUO hinges in the colour of black	without an extra charge
pattern 07 - in case of double-leaf door, symmetrical division available on request: "60"+ "60", "70"+ "70", "80"+ "80", "90"+ "90"	rail and stile set (for do-it-yourself shortening to 50 mm)
asymmetric double-leaf door unavailable on request (only 07 version)	rail and stile set (for do-it-yourself shortening to 90 mm)
patterns 01-06 - milling width 6 mm pattern 07 - milling width 4 mm	reinforcement for door closer
ADDITIONAL (available at an extra charge)	bottom rail and stile set protector against excessive moisture (except door leaves with ventilation undercut)
size "100"	door lower by 50 mm or 100 mm (rebated sys.)
size "110"	without an extra charge
REVES (reverse rebate) system	door lower by 55 mm or 100 mm (non-rebated sys.)
recuperation trim	without an extra charge
perforated chipboard in-fill	door higher by 50 mm or 100 mm (third hinge required at an extra charge)
solid chipboard in-fill (third hinge recommended)	without an extra charge
	door higher by 150 mm or 200 mm (third hinge required at an extra charge)
	+10%
	ventilation undercut (p. 245)
	door leaf edge in the colour of black, grey or graphite (except the REVES system)
	without an extra charge

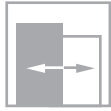
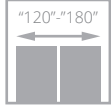
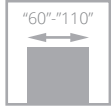

SIMPLE door, 00 pattern, DIN SYSTEM adjustable door frame

SIMPLE

NEW COLOURS



- **robust structure - wooden rail and stile set**
- **3-layered painting system** - colour fastness for many years
- wide range of **RAL and NCS colours**
- **adjustable** type K, type C hinge and adjustable type DUO hinge



milled pattern view



DUO hidden hinge, white - optional for non-rebated sys.



new type of milling



laminated door leaf edge in the colour of black, graphite or grey - option (except the BLACK surface)



SIMPLE door, 02 pattern (door on the left), 00 pattern (door on the right), DIN SYSTEM adjustable door frame



VERSION **00 / VF0** **01 / VF1SD** **02 / VF2SD** **03 / VF4SD** **04 / VF4SM**

WHITE
GREY, BEIGE
BLACK, SAGE

COLOURS



Only applicable to Simple door leaves and DIN, DIN DUO and Vertigo door frames.

OPTIONAL COLOURS



extra charge added to the basic white colour, RAL 9003 acc. to RAL, NCS colour groups (p. 264)

Group I	Group II	Group III	Group IV	Group V
---------	----------	-----------	----------	---------

HIGHER DOOR



DOOR FRAMES

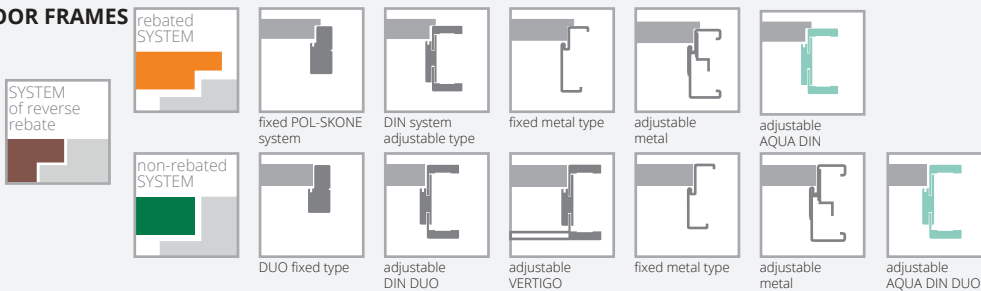

EQUIPMENT

STANDARD	
white matt or translucent 4 mm thick glass	
for pattern 01 and 02 white matt 4 mm thick tempered glass	
single-point lock, spacing: 72 mm (rebated sys.) or magnetic (non-rebated sys.) mortise lock, for key (spacing: 90 mm), for cylinder (spacing: 85 mm) or for bathroom privacy lock (spacing: 90 mm)	
hinges: type K, silver - for DIN system door frame, type C, silver - for wooden door frame, type M - for metal door frame or hidden DUO nickel satin ("60"-80" - 2 pcs, "90" - 3 pcs)	
for a leaf with a door closer and DIN or metal frame, use type T hinges in the quantity of "60"-80" - 3 pieces, "90"-110" - 4 pcs. (replacement of standard hinges for type T hinge for an extra charge)	
collection BLACK: standard face plate of magnetic lock and DUO hinges in the colour of black	
ADDITIONAL (available at an extra charge)	
size "100" (glazing decoration as in "90")	change of standard DUO hinge to the colour of white or black (for 1 piece)
size "110" (glazing decoration as in "90")	rebated system, collection BLACK: lock colour change to black
REVES (reversed rebate) system (version 00)	without an extra charge
recuperation trim	rail and stile set (for do-it-yourself shortening to 50 mm)
without an extra charge	rail and stile set (for do-it-yourself shortening to 90 mm)
perforated chipboard in-fill	reinforcement for door closer
solid chipboard in-fill (third hinge recommended)	bottom rail and stile set protector against excessive moisture (except door leaves with ventilation undercut)
third hinge in the door leaf or adjustable pivot hinge (1 piece price):	door lower by 50 mm or 100 mm (rebated sys.)
type M for width "60"-80"	without an extra charge
type C for width "60"-80"	door lower by 55 mm or 100 mm (non-rebated sys.)
type K for width "60"-80"	without an extra charge
concealed DUO type for width "60"-80"	door higher by 50 mm or 100 mm (third hinge required at an extra charge)
	+10%
	door higher by 150 mm or 200 mm (third hinge required at an extra charge)
	+20%
	ventilation undercut (p. 245)
	door leaf edge in the colour of black, grey or graphite (except the REVES system)
	without an extra charge
	tempered glass (versions 03, 04)
	transparent 4 mm tempered thick glass (versions 01, 02)
	+10%

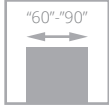

FIORD door, 00 pattern, DIN SYSTEM DUO adjustable door frame

FIORD



- **robust structure - wooden rail and stile set**
- **3-layered painting system** - colour fastness for many years
- wide range of **RAL and NCS colours**
- **adjustable type K, type C hinge and adjustable type DUO hinge**



glazing, moulding



DUO hidden hinge, white - optional for non-rebated sys.



door leaf profile



FIORD door, 00 pattern, adjustable door frame





VERSION **00 / V03** **01 / V3S1** **03 / V3S3** **04 / V3SD**

WHITE
GREY, BEIGE
BLACK, SAGE

COLOURS



Only applicable to Fiord 00 door leaf and DIN, DIN DUO, Vertigo door frames.

OPTIONAL COLOURS



extra charge added to the basic white colour, RAL 9003 acc. to RAL, NCS colour groups (p. 264)

Group I	Group II	Group III	Group IV	Group V
---------	----------	-----------	----------	---------

DOOR FRAMES

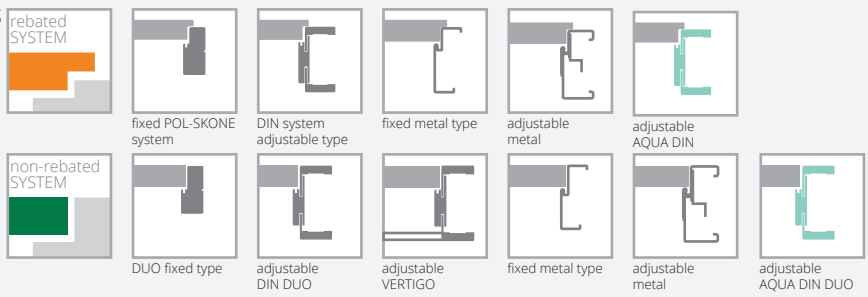

EQUIPMENT

STANDARD	white matt or translucent 4 mm thick glass; version 04: white matt tempered 4 mm thick glass	change of standard DUO hinge to the colour of white or black (for 1 piece)	
	single-point lock, spacing: 72 mm (rebated sys.) or magnetic (non-rebated sys.) mortise lock, for key (spacing: 90 mm), for cylinder (spacing: 85 mm) or for bathroom privacy lock (spacing: 90 mm)	rebated system, collection BLACK: lock colour change to black	without an extra charge
	hinges: type K silver - for DIN system door frame, type C silver - for wooden door frame, type M - for metal door frame or hidden DUO nickel satin ("60"-80" - 2 pcs, "90" - 3 pcs)	change of the DUO lock colour to black or golden gloss	
	for a leaf with a door closer and DIN or metal door frame, use type T hinges in the quantity of "60"-80" - 3 pieces, "90" - 4 pcs. (replacement of standard hinges for type T hinge for an extra charge)	reinforcement for door closer	
	collection BLACK: standard face plate of magnetic lock and DUO hinges in the colour of black	bottom rail and stile set protector against excessive moisture (except door leaves with ventilation undercut)	
ADDITIONAL (available at an extra charge)	recuperation trim	door lower by 50 mm or 100 mm (rebated sys.)	without an extra charge
	solid chipboard in-fill (third hinge recommended)	door lower by 55 mm or 100 mm (non-rebated sys.)	without an extra charge
	third hinge in the door leaf:	ventilation undercut (p. 245)	
	type M for width "60"-80"	transparent 4 mm thick tempered glass	+10%
	type C for width "60"-80"		
	type K for width "60"-80"		
	concealed DUO type for width "60"-80"		

SEMPRE LUX

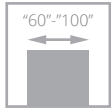

for door leaves with ventilation option



- **robust wooden frame-based structure**
- doors covered **with natural veneers**
- **environment-friendly UV varnish** ensures colour fastness and resistance to scratches
- leaves are available with a one-sided **magnetic board (Z/AZ)** and a **one-sided mirror (WL Z, WL AZ)**
- adjustable type K, type C hinge and adjustable DUO hinge



rail and stile set wood grain



horizontal wood grain of boards

SEMPRE LUX door, W04 pattern, DIN SYSTEM adjustable door frame



INTERIOR DOORS RAIL AND STILE TYPE VENEERED



SEMPRE LUX door, W0354 pattern, POL-SKONE system adjustable door frame



VERSION W00 / V01 W01 / V1SD W04 / V4SM W05 / V4SD Z A/Z WLZ WLA/Z W02P / V02 W02 / V2S5 W02S1 / V2S1 W02S2 / V2S2

GROUP A

GROUP B

GROUP C, D



VERSION W02S3 / V2S3 W02S4 / V2S4 W02A / V2SA W03P / V03 W03 / V3S5 W03S1 / V3S1 W03S2 / V3S2 W03S3 / V3S3 W03S4 / V3S4 W03A / V3SA

GROUP A

GROUP B

GROUP C, D

* Z, WLZ - board/mirror on the hinge side, A/Z, WLA/Z - board/mirror on the side opposite to the hinge side

COLOURS



VERSION W06 / V05 W07 / V06 W05 VERSE / V6SD

GROUP A

GROUP B

GROUP C, D

* colours available subject to consultation with the Sales Department

DOOR FRAMES

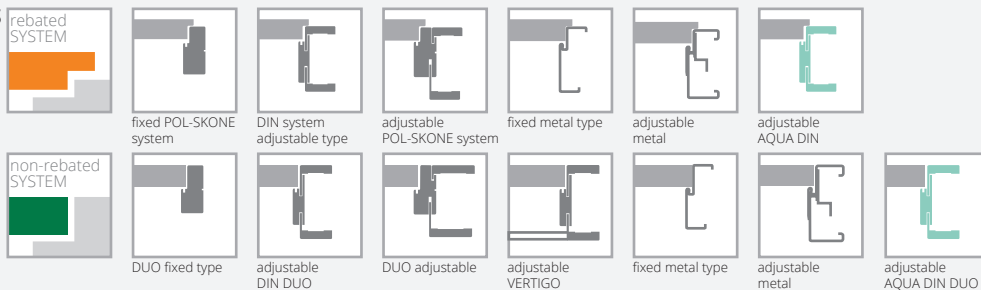

EQUIPMENT

STANDARD		
white / brown / graphite or translucent 4 mm glass		
pattern W01, W05 - 4 mm tempered glass		
pattern W00, 12 mm thick panel		
single-point lock, spacing: 72 mm (rebated sys.) or magnetic (non-rebated sys.) mortise lock, for key (spacing: 90 mm), for cylinder (spacing: 85 mm) or for bathroom privacy lock (spacing: 90 mm)		
hinges: type K brushed nickel - for DIN system door frame, type C brushed nickel - for wooden door frame, type M - for metal door frame or hidden DUO nickel satin ("60"- "80" - 2 pcs, "90" - 3 pcs)		
not available with a door closer		
not available with a drop seal		
VERSE version W05 - only applicable to width "70" - "100"		
ADDITIONAL (available at an extra charge)		
size "100"	+20%	
recuperation trim (only standard height)	+10%	
		third hinge in the door leaf:
		type C for width "60"- "80"
		type K for width "60"- "80"
		type M for width "60"- "80"
		concealed DUO type for width "60"- "80"
		door lower by 50 mm (rebated sys.) (except WLZ, WLA/Z)
		without an extra charge
		door lower by 55 mm (non-rebated sys.) (except WLZ, WLA/Z)
		without an extra charge
		door higher by 50 mm or 100 mm (third hinge required for an extra charge) (except WLZ, WLA/Z)
		+10%
		ventilation undercut (p. 245)
		laminated VSG 22.1 glass, black (only applicable to 1 glass pane):
		version W02
		version W03
		transparent 4 mm thick tempered glass
		+10%

FORTIMO LUX

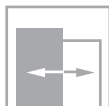
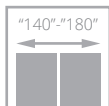
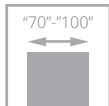

for door leaves with ventilation option

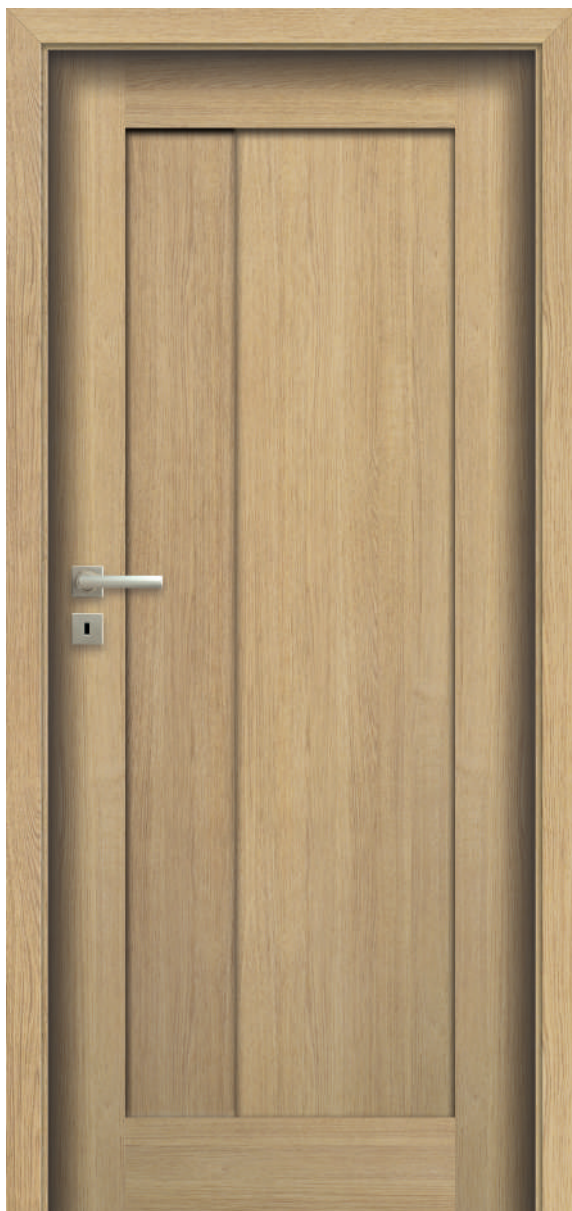

NEW COLOURS

- **robust wooden frame-based structure**
- doors covered **with natural veneers**
- **environment-friendly UV varnish** ensures colour fastness and resistance to scratches
- vertical **wood grain**
- **4 mm thick tempered glass pane** in the colour of white matt, brown, graphite or transparent
- adjustable type K, type C and adjustable type DUO hinge



glazing, board



interconnection of architraves at an angle of 45°

FORTIMO LUX door, W03 pattern, DIN SYSTEM adjustable door frame



INTERIOR DOORS RAIL AND STILE TYPE VENEERED



FORTIMO LUX door, W03S1 pattern, SYSTEM VERTIGO adjustable door frame



VERSION **W01 / V01** **W01S1 / V1S** **W03 / V02** **W03S1 / V2S**

GROUP A

GROUP B

GROUP C, D

COLOURS

VENEERED GROUP A						
	312 limba	334 European oak				
VENEERED GROUP B						
	340 ebony	351 marrone*	390 natural walnut			
	404 dark walnut	405 bright walnut	421 cappuccino	422 mocca	424 teak	
VENEERED GROUP C						
	370 white-stained oak					
VENEERED GROUP D						
	311 bright oak*	NEW 313 classic oak	460 macassar			

* colours available subject to consultation with the Sales Department

DOOR FRAMES

rebated SYSTEM							
	fixed POL-SKONE system	DIN system adjustable type	adjustable POL-SKONE system	fixed metal type	adjustable metal	adjustable AQUA DIN	
non-rebated SYSTEM							
	DUO fixed type	adjustable DIN DUO	DUO adjustable	adjustable VERTIGO	fixed metal type	adjustable metal	adjustable AQUA DIN DUO

EQUIPMENT

STANDARD	recuperation trim (only standard height)	+10%
white matt 4 mm thick tempered glass	third hinge in the door leaf:	
single-point lock, spacing: 72 mm (rebated sys.) or magnetic (non-rebated sys.) mortise lock, for key (spacing: 90 mm), for cylinder (spacing: 85 mm) or for bathroom privacy lock (spacing: 90 mm)	type C for width "60"- "80"	
hinges: type K - for DIN system door frame, type C - for wooden door frame, type M - leaf for metal door frame or hidden DUO nickel satin ("60"- "80" - 2 pcs, "90" - 3 pcs)	type K for width "60"- "80"	
ADDITIONAL (available at an extra charge)	type M for width "60"- "80"	
size "100"	concealed DUO type for width "60"- "80"	
size "60" (only W01, W01S1)	door lower by 50 mm (rebated sys.)	without an extra charge
	door lower by 55 mm (non-rebated sys.)	without an extra charge
	ventilation undercut (p. 245)	
	laminated VSG 22.1. matt, transparent or black glass	
	brown, graphite or transparent 4 mm thick tempered glass	+10%

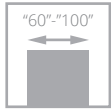

for door leaves with ventilation option



INTERSOLID

NEW COLOURS



- **robust wooden frame-based structure**
- doors covered **with natural veneers**
- **environment-friendly UV varnish** ensures colour fastness and resistance to scratches
- adjustable type K, type C hinge



INTERSOLID door, 02 pattern, DIN SYSTEM adjustable door frame

INTERSOLID moulding



INTERIOR DOORS RAIL AND STILE TYPE **VENEERED**



INTERSOLID door, 05 pattern (door on the left), 05 S8 pattern (door on the right), DIN SYSTEM adjustable door frame



VERSION	02 / V02	02S6 / V2S6	05 / V05	05S8 / V5S8	08 / V08	08S10 / V8S10
---------	----------	-------------	----------	-------------	----------	---------------

GROUP A
GROUP B
GROUP C, D

COLOURS



DOOR FRAMES

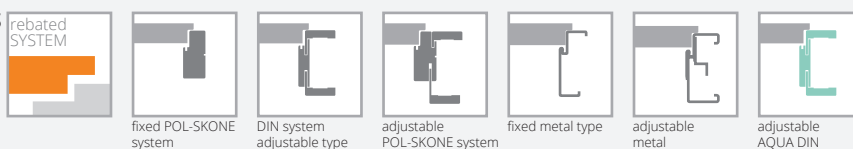

EQUIPMENT

STANDARD	ADDITIONAL (available at an extra charge)
white matt or transparent 4 mm thick glass	size "100" +20%
single-point mortise lock, spacing: 72 mm, for key, cylinder or for bathroom privacy lock	third hinge in the door leaf: type C for width "60"- "80" type K for width "60"- "80" type M for width "60"- "80"
hinges: type K - for DIN system door frame, type C - for wooden door frame, type M - leaf for metal door frame ("60"- "80" - 2 pcs, "90" - 3 pcs)	bottom rail and stile set protector against excessive moisture (except door leaves with ventilation undercut)
	door lower by 50 mm without an extra charge
	door higher by 50 mm or 100 mm (third hinge required at an extra charge) +10%
	ventilation undercut (p. 245)
	white matt or transparent 4 mm thick tempered glass +10%

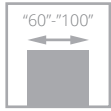

for door leaves with ventilation option



INTERSOLID II



- **robust wooden frame-based structure**
- door covered **with natural veneers**
- **environment-friendly UV varnish** ensures colour fastness and resistance to scratches
- **decorative milled panels**
- adjustable type K, type C hinge



wooden muntin



door leaf profile

INTERSOLID II door, 02 S6 pattern, DIN SYSTEM adjustable door frame



INTERIOR DOORS RAIL AND STILE TYPE **VENEERED**



INTERSOLID II door, 02 pattern, adjustable door frame



VERSION 01 / V01 01S6 / V1S6 02 / V02 02S6 / V2S6 03 / V03 03S6 / V3S6 04 / V04 04S8 / V4S8 05 / V05

GROUP A
GROUP B



VERSION 05S8 / V5S8 06 / V06 06S8 / V6S8 07 / V07 07S10 / V7S10 08 / V08 08S10 / V8S10 09 / V09 09S10 / V9S10

GROUP A
GROUP B

COLOURS

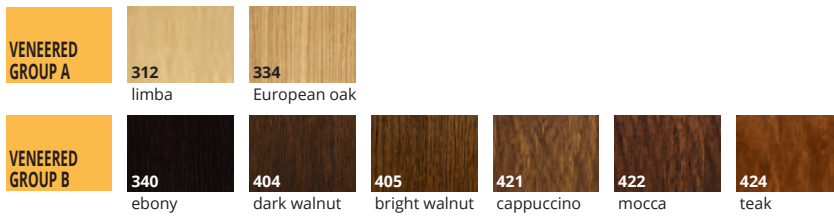

DOOR FRAMES



EQUIPMENT

STANDARD	ADDITIONAL (available at an extra charge)
white matt or transparent 4 mm thick glass	size "100" +20%
single-point mortise lock, spacing: 72 mm, for key, cylinder or for bathroom privacy lock	third hinge in the door leaf: type C for a width of "60"- "80" type K for a width of "60"- "80" type M for width "60"- "80"
hinges: type K - for DIN system door frame, type C - for wooden door frame, type M - leaf for metal door frame ("60"- "80" - 2 pcs, "90" - 3 pcs)	bottom rail and stile set protector against excessive moisture (except door leaves with ventilation undercut)
	door lower by 50 mm without an extra charge
	door higher by 50 mm or 100 mm (third hinge required at an extra charge) +10%
	ventilation undercut (p. 245)
	white matt or transparent 4 mm thick tempered glass +10%

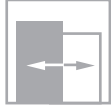
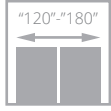
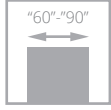

for door leaves with ventilation option



PASSO

NEW COLOURS

- **robust wooden frame-based structure**
- **colours** from LAMISTONE CPL, SILKSTONE and natural veneer **surfaces**
- stile - vertical or horizontal wood grain (version H), horizontal boards
- wide 24 mm thick boards
- adjustable type K, type C and adjustable type DUO hinge



rail and stile set, boards and glass pane connection



top door leaf edge without a rebate

PASSO door, W05 pattern, DIN SYSTEM DUO adjustable door frame



INTERIOR DOORS RAIL AND STILE TYPE **VENEERED**



PASSO door, W03 pattern (door on the left), W02 pattern (door on the right), DUO adjustable door frame



VERSION W01 / V01 W02 / V1S1 W03 / V1S2 W04 / V1S3 W05 / V1S4 W06 / V2SD W07 / V3SD

LAMISTONE
SILKSTONE

GROUP A

GROUP B

COLOURS

LAMISTONE CPL	231 halif oak	243 delano oak	244 black	250 terra oak	260 white oak	NEW 213 superwhite
	263 premium walnut	265 wenge	289 grey	531 anthracite	232 segato walnut	
SILKSTONE	230 gran oak	254 Royal H anthracite	255 Polish ash H	276 Polish oak	293 Royal anthracite	294 Royal ash
	295 Royal merbau	297 Royal nougat	299 Royal H ash			
	312 limba	334 European oak				
VENEERED GROUP A						
VENEERED GROUP B	340 ebony	404 dark walnut	405 bright walnut	421 cappuccino	422 mocca	424 teak

DOOR FRAMES

rebated SYSTEM					
	fixed POL-SKONE system	DIN system adjustable type	adjustable POL-SKONE system	adjustable AQUA DIN	
non-rebated SYSTEM					
	DUO fixed type	adjustable DIN DUO	DUO adjustable	adjustable VERTIGO	adjustable AQUA DIN DUO

EQUIPMENT

STANDARD	ADDITIONAL (available at an extra charge)
<p>painted white/brown matt or transparent 4 mm thick glass</p> <p>single-point lock, spacing: 72 mm (rebated sys.) or magnetic (non-rebated sys.) mortise lock, for key (spacing: 90 mm), for cylinder (spacing: 85 mm) or for bathroom privacy lock (spacing: 90 mm)</p> <p>hinges: type K - for DIN system door frame, type C - for wooden door frame or hidden DUO nickel satin ("60"-80" - 2 pcs, "90" - 3 pcs)</p> <p>not available with a door closer</p> <p>not available with a drop seal</p>	<p>third hinge in the door leaf: type C for width "60"-80" type K for width "60"-80" concealed DUO type for width "60"-80"</p> <p>door lower by 55 mm (non-rebated sys.) without an extra charge</p> <p>door lower by 50 mm (rebated sys.) without an extra charge</p> <p>ventilation undercut (p. 245)</p> <p>transparent 4 mm thick tempered glass +10%</p>

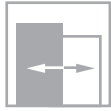
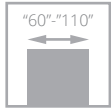

ESPINA door, W03 pattern, DIN SYSTEM adjustable door frame

ESPINA

NEW
PATTERN



- **robust structure - wooden rail and stile set**
- stable in-fill **made of perforated board**
- **perfect combination** of black and natural veneers
- environment-friendly UV varnish ensures colour fastness and resistance to scratches
- **safe 6 mm thick tempered glass pane** in the colour of white matt or laminated black 8.5 mm thick VSG 44.2 glass pane
- adjustable type K, type C hinge and adjustable DUO hinge

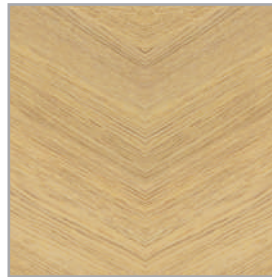

wood grain



ESPINA door, W03 pattern, DIN SYSTEM door frame

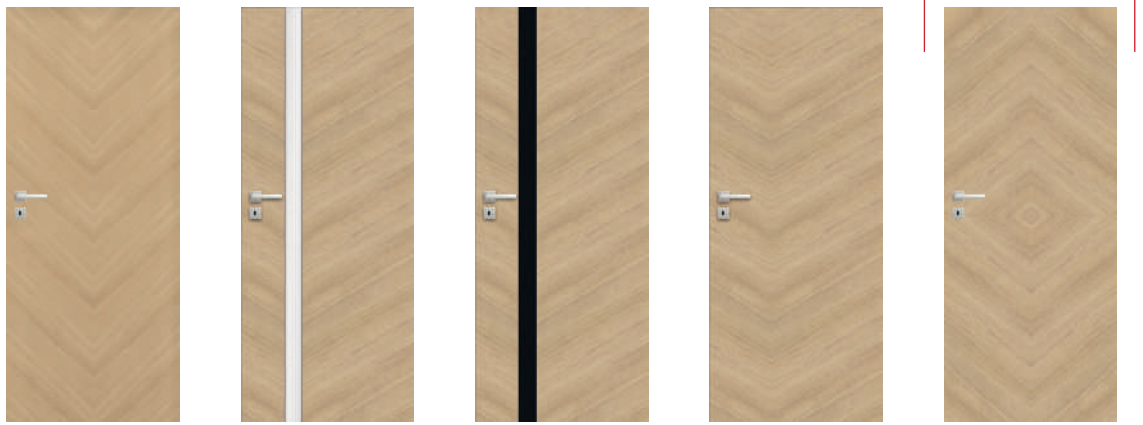

VERSION **W00 / V00** **W01 / V1S** **W01 / V1S** **W02 / V01** **W03 / V03**

GROUP A
GROUP B
GROUP D

COLOURS

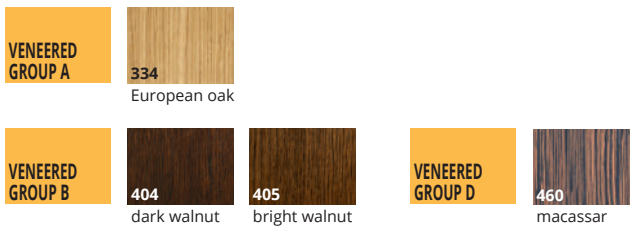

DOOR FRAMES

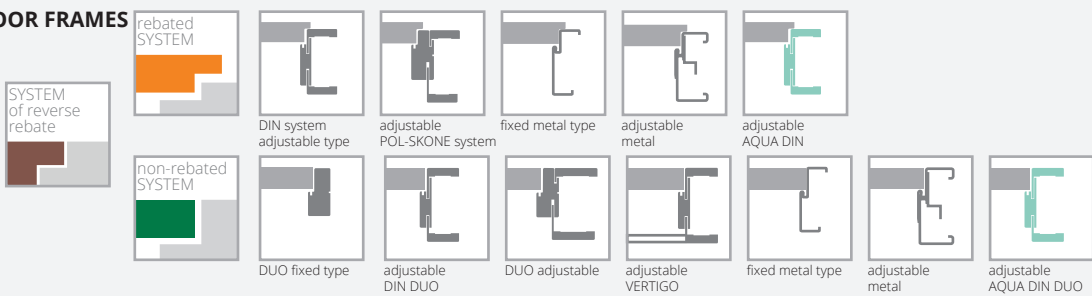

EQUIPMENT

STANDARD		
6 mm thick tempered glass in the colour of white matt		
laminated 8.5 mm thick 44.2 glass in the colour of black		
single-point lock, spacing: 72 mm (rebated sys.) or magnetic (non-rebated sys.) mortise key-operated lock (spacing: 90 mm), for cylinder (spacing: 85 mm) or bathroom privacy lock (spacing: 90 mm)		
hinges: type K – for DIN system door frame, type C – for wooden door frame, type M – door leaf for metal door frame ("60"-80" - 2 pcs., "90" - 3 pcs) or hidden DUO nickel satin ("60"-70" - 2 pcs, "80"-90" - 3 pcs)		third hinge in the door leaf: type T for a width of "60"-80" type C for width "60"-80" type K for width "60"-80" type M for width "60"-80" concealed DUO type for width "60"-70"
door leaf with door closer and DIN door frame or metal door frame should be equipped with type T hinges in the number of "60"-80" - 3 pcs, "90"-110" - 4 pcs (standard hinges are replaced with type T hinges at extra charge)		rail and stile set (for do-it-yourself shortening to 50 mm) except pattern W01
ADDITIONAL (available at an extra charge)		rail and stile set (for do-it-yourself shortening to 90 mm) except pattern W01
size "100"	+20%	reinforcement for door closer (except version W01)
size "110" (versions: W00, W02, W03 only)	+40%	bottom rail and stile set protected against excessive moisture (except door leaves with ventilation undercut)
REVES system (reversed rebate) (versions: W00, W01, W02, W03)		door lower by 50 mm or 100 mm (rebated sys.)
recuperation trim	without an extra charge	without an extra charge
solid chipboard in-fill (third hinge recommended)		door lower by 55 mm or 100 mm (non-rebated sys.)
		door higher by 50 mm or 100 mm (third hinge required at extra charge)
		door higher by 150 mm or 200 mm (third hinge required at extra charge)
		ventilation undercut (pattern W00, W02, W03)
		ventilation required (pattern W01)

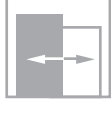
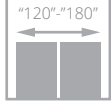
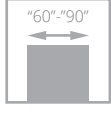

TEO

NEW



- door covered **with natural veneer**
- environment-friendly UV varnish ensures colour fastness and resistance to scratches
- unique **decorative milling** in the colour of **black**, **protected with varnish**

TEO door, VF1 pattern, DIN SYSTEM adjustable door frame

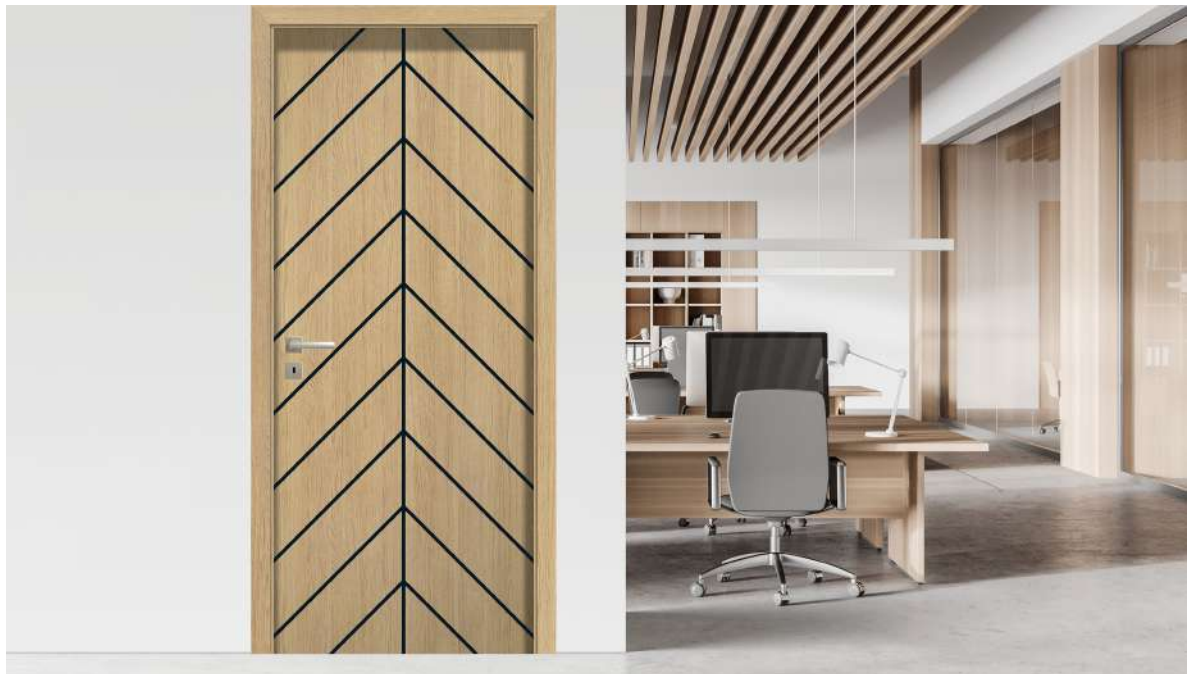

TEO door, VF6 pattern, DIN adjustable door frame



VERSION VF1 VF2 VF3 VF4



VERSION VF5 VF6 VF7

COLOURS

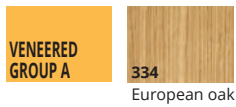

DOOR FRAMES

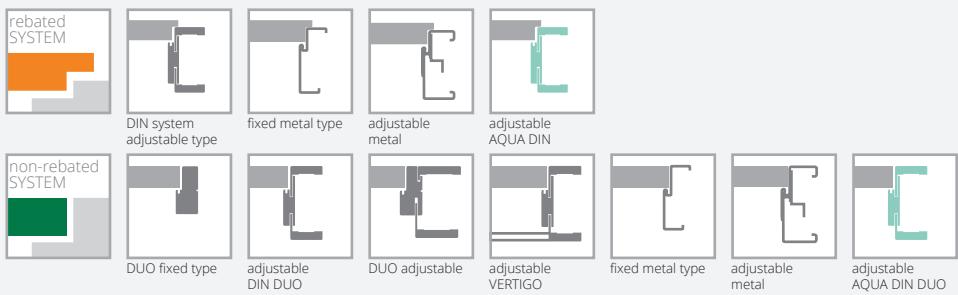

EQUIPMENT

STANDARD	ADDITIONAL (available at an extra charge)
wooden rail and stile set topped with two HDF boards with veneered surface with decorative milling in the colour of black	lock colour change to silver without an extra charge
single-point lock, spacing: 72 mm (rebated sys.) or magnetic (non-rebated sys.) mortise lock, for key (spacing: 90 mm), for cylinder (spacing: 85 mm) or for bathroom lock (spacing: 90 mm) in the colour of black	size "100" +20%
black hinges: type T – for the DIN system door frame and the metal door frame ("60"- "80" – 2 pcs, "90" – 3 pcs) or DUO hidden ("60"- "70" – 2 pcs, "80"- "90" – 3 pcs)	rail and stile set (ready for DIY shortening of the door leaf by max. 50 mm)
	reinforcement for door closer
	bottom rail and stile set protected against excessive moisture (except door leaves with ventilation undercut)
	third hinge in the door leaf: type T for a width of "60"- "80" concealed DUO type for width "60"- "70"
	ventilation undercut

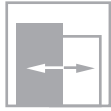
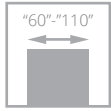

DECO LUX door, 00 pattern, DIN SYSTEM adjustable door frame

DECO LUX with the Soft moulding

NEW COLOURS



- **robust structure - wooden rail and stile set**
- doors covered **with natural veneers**
- **environment-friendly UV varnish** ensures colour fastness and resistance to scratches
- adjustable type K, type C hinge and adjustable DUO hinge

INTERIOR DOORS **VENEERED**



DECO LUX door, 00 pattern, DIN SYSTEM door frame



VERSION **00 / V00** **02 / V2S** **03SD / V3SD** **04 / V4SD** **05 / V5SD**

GROUP A

GROUP B

GROUP C, D

COLOURS

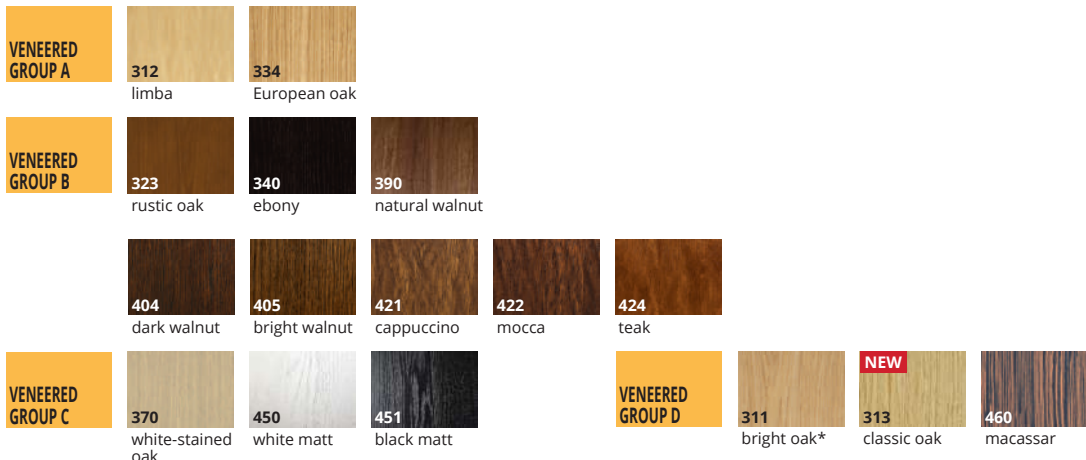

* colours available subject to consultation with the Sales Department

DOOR FRAMES

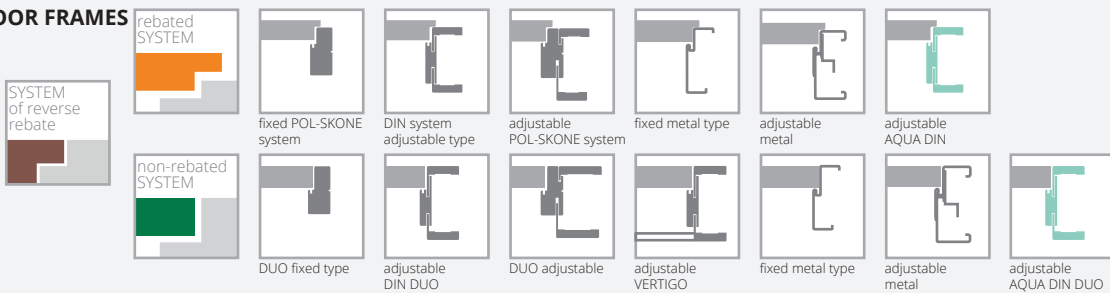

EQUIPMENT

STANDARD			
white matt or translucent 4 mm thick glass		rail and stile set (for do-it-yourself shortening to 50 mm)	
version 03SD: white matt tempered glass		rail and stile set (for do-it-yourself shortening to 90 mm)	
single-point lock, spacing: 72 mm (rebated sys.) or magnetic (non-rebated sys.) mortise lock, for key (spacing: 90 mm), for cylinder (spacing: 85 mm) or for bathroom privacy lock (spacing: 90 mm)		reinforcement for door closer	
hinges: type K silver - for DIN system door frame, type C - for wooden door frame, type M - leaf for metal door frame or hidden DUO nickel satin ("60"-80" - 2 pcs, "90" - 3 pcs)		bottom rail and stile set protector against excessive moisture (except door leaves with ventilation undercut)	
for a leaf with a door closer and DIN or metal frame, use type T hinges in the quantity of "60"-80" - 3 pieces, "90"-110" - 4 pcs. (replacement of standard hinges for type T hinge for extra charge)		door lower by 50 mm or 100 mm (rebated sys.)	without an extra charge
ADDITIONAL (available at an extra charge)		door lower by 55 mm or 100 mm (non-rebated sys.)	without an extra charge
size "100" (glazing decoration as in "90")	+20%	door higher by 50 mm or 100 mm (third hinge required at an extra charge)	+10%
size "110" (glazing decoration as in "90")	+40%	door higher by 150 mm or 200 mm (third hinge required at an extra charge)	+20%
REVES (reversed rebate) system (version 00)		ventilation undercut (p. 245)	
recuperation trim	without an extra charge	tempered glass: versions: 02, 04, 05	
perforated chipboard in-fill		transparent 4 mm thick tempered glass	+10%
solid chipboard in-fill (third hinge recommended)		DECO LUX door in mechanical class III available on request	technical door catalogue
third hinge in the door leaf:			
type C for a width of "60"-80"			
type K for a width of "60"-80"			
type M for width "60"-80"			
concealed DUO type for width "60"-80"			

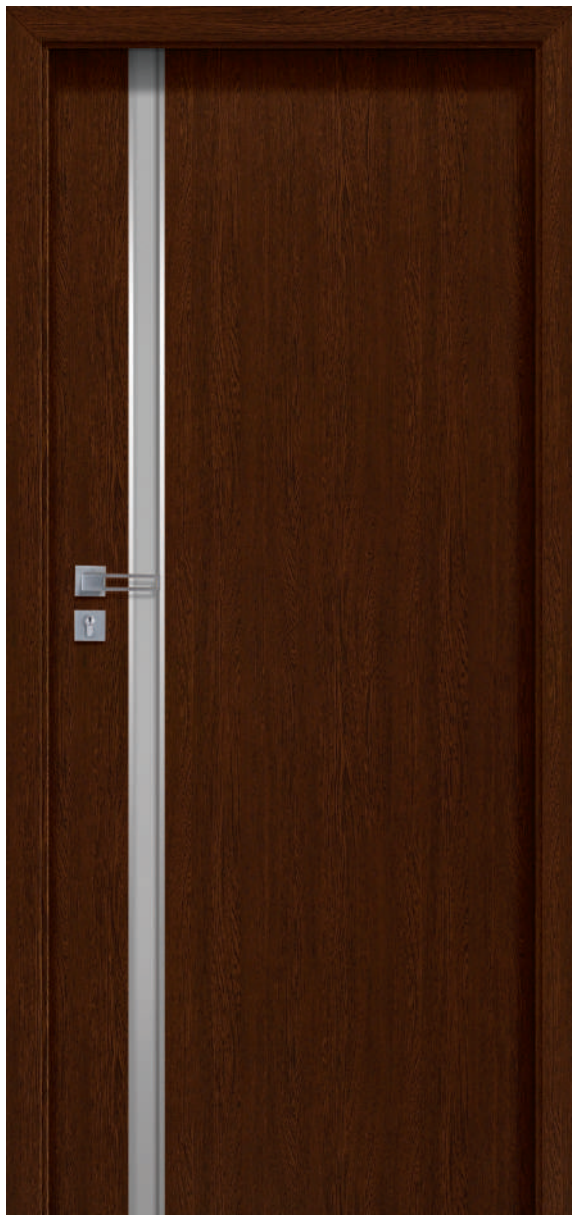
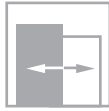
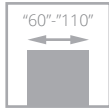

ETIUDA LUX door, A01 pattern, DIN SYSTEM adjustable door frame

ETIUDA LUX

- robust structure - wooden rail and stile set
- **door covered with natural veneers**
- **environment-friendly UV varnish** ensures colour fastness and resistance to scratches
- 6 mm thick tempered glass pane in the colour of white matt or graphite
- decorative glazing mouldings in the colour of silver or black
- adjustable type K, type C and adjustable type DUO hinge



aluminium glazing mouldings in the colour of silver or black

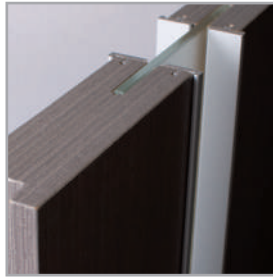

top door leaf edge without a rebate



option: aluminium decorative mouldings in the colour of black



ETIUDA LUX door, A02 pattern, DIN SYSTEM adjustable door frame



VERSION **B0 / V00** **B1 / VD11** **A01 / V1SA** **A02 / V2SA** **A03 / V3SA**

GROUP A

GROUP B

COLOURS



DOOR FRAMES

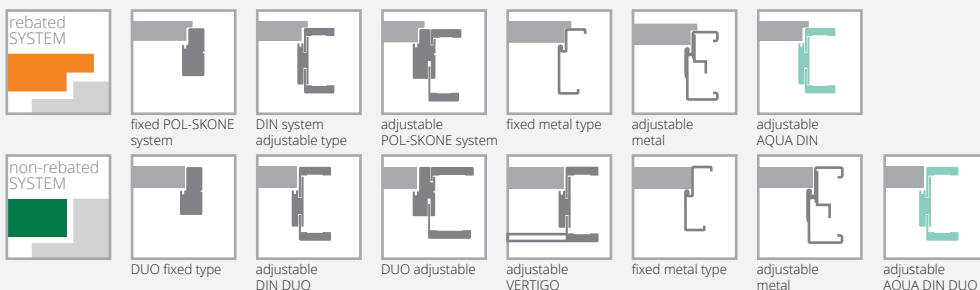

EQUIPMENT

STANDARD	
white/brown matt 6 mm thick tempered glass	reinforcement for a door closer (except versions: A01, A02, A03)
glass pane in the colour of black is unavailable	bottom rail and stile set protector against excessive moisture (except door leaves with ventilation undercut) (except versions: A01, A02, A03)
glazing width in versions A01 – 54 mm; A02 – 205 mm, A03 – 276 mm*	door lower by 50 mm or 100 mm (rebated sys.) (except versions: A01, A02, A03)
single-point lock, spacing: 72 mm (rebated sys.) or magnetic (non-rebated sys.) mortise lock, for key (spacing: 90 mm), for cylinder (spacing: 85 mm) or for bathroom privacy lock (spacing: 90 mm)	door lower by 55 mm or 100 mm (non-rebated sys.) (except versions: A01, A02, A03)
hinges: type K silver - for DIN system door frame, type C - for wooden door frame, type M - leaf for metal door frame or hidden DUO nickel satin ("60"-80" – 2 pcs, "90" – 3 pcs)	door higher by 50 mm or 100 mm (third hinge required at an extra charge) (except versions A01, A02, A03)
version B1: solid board in-fill	door higher by 150 mm or 200 mm (third hinge required at an extra charge) (except versions: A01, A02, A03)
ADDITIONAL (available at an extra charge)	
size "100"	+20%
size "110" (versions: B0, B1 only)	+40%
solid chipboard in-fill (versions: B0, A01, A02, A03) (third hinge recommended)	
third hinge in the door leaf:	
type C for width "60"-80"	
type K for width "60"-80"	
type M for width "60"-80"	
concealed DUO type for width "60"-80"	
rail and stile set (for do-it-yourself shortening to 50 mm) (version B0 only)	
rail and stile set (for do-it-yourself shortening to 90 mm) (version B0 only)	
change of colour of decorative mouldings to black:	
version B1	
version A01-A03	

without an extra charge
without an extra charge
+10%
+20%
without an extra charge
without an extra charge
+10%
+20%
+10%
p. 238-243

*dimension tolerance +/- 2 mm

ESTATO LUX

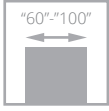

- **robust structure - wooden rail and stile set**
- **stable perforated board in-fill**
- doors covered **with natural veneers**
- environment-friendly UV varnish ensures colour fastness and resistance to scratches
- vertical **wood grain**
- **safe 6 mm thick tempered** glass pane in the colour of white/brown matt or **laminated 8.5 mm thick VSG 44.2 glass pane** in the colour of black



ESTATO LUX door, A01 pattern, DIN adjustable door frame

black pane



ESTATO LUX door, A01 pattern, DIN SYSTEM DUO adjustable door frame



WHITE / BROWN MATT TEMPERED GLASS PANE

LAMINATED BLACK GLASS PANE

VERSION A01 / V1SA A02 / V2SA A03 / V3SA A01 / V1SA black pane A02 / V2SA black pane A03 / V3SA black pane

GROUP A
GROUP B



LAMINATED WHITE MATT GLASS PANE

VERSION A01 / V1SA A02 / V2SA A03 / V3SA

GROUP A
GROUP B

COLOURS



DOOR FRAMES

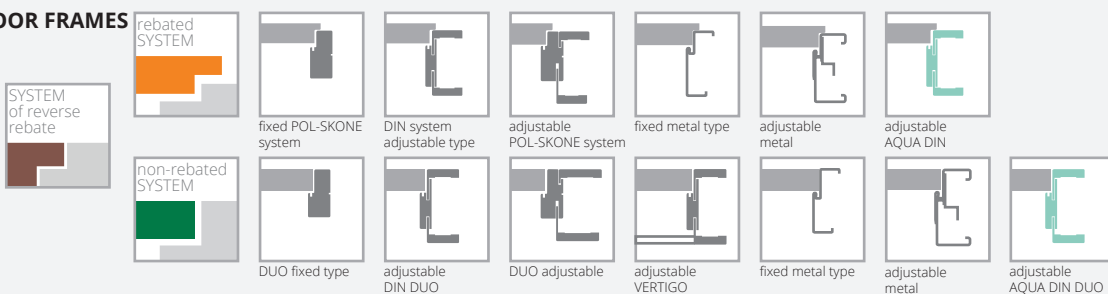

EQUIPMENT

STANDARD	
white/brown matt 6 mm thick tempered glass (patterns: A01 - 58 mm, A02 - 208 mm, A03 - 280 mm)*	
laminated 8.5 mm thick 44.2 glass in the colour of black or white matt	
single-point lock, spacing: 72 mm (rebated sys.) or magnetic (non-rebated sys.) mortise lock, for key (spacing: 90 mm), for cylinder (spacing: 85 mm) or for bathroom privacy lock (spacing: 90 mm)	
silver: type T – for the DIN system door frame and the metal door frame, type C – for the wooden door frame, ("60"-80" – 2 pcs, "90" – 3 pcs) or hidden DUO nickel satin for the non-rebated system ("60"-70" – 2 pcs, "80"-90" – 3 pcs)	
not available with a door closer	
ADDITIONAL (available at an extra charge)	
size "100"	+20%
REVES (reverse rebate) system	
solid chipboard in-fill (third hinge recommended)	

third hinge in the door leaf: type C for width "60"-80" type T for a width of "60"-80" hidden DUO for a width of "60"-70"	
versions: A01, A02, A03 door lower by 50 mm (rebated sys.)	without an extra charge
versions: A01, A02, A03 door lower by 55 mm (non-rebated sys.)	without an extra charge
versions: A01, A02, A03 door higher by 100 mm (third hinge required at an extra charge)	+10%
versions: A01, A02, A03 door higher by 200 mm (third hinge required at an extra charge)	+20%
ventilation undercut (except versions A02, A03) (p. 245)	
ventilation undercut A01 with widths "60" - "100" (p. 245)	
ventilation undercut A02, A03 with widths "70" - "100" (p. 245)	
tempered 6 mm glass in the colour of graphite or transparent sliding system (except version A01)	+10%

*Possible tolerance +/- 1-2 mm

SONATA LUX

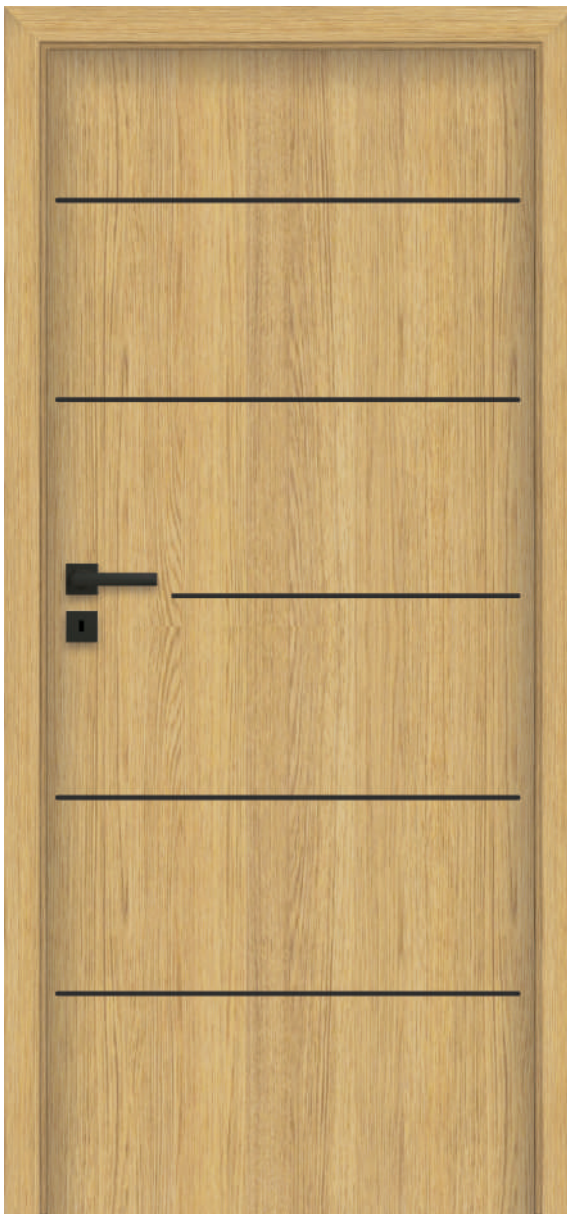
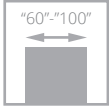

- **robust structure - wooden rail and stile set**
- stable in-fill **made of perforated board**
- doors covered **with natural veneers**
- **environment-friendly UV varnish** ensures colour fastness and resistance to scratches
- **aluminium decors** in the colour of black
- adjustable type K, type C and adjustable type DUO hinge

SONATA LUX door, W5 pattern, DIN SYSTEM adjustable door frame



SONATA LUX door, W2 pattern, DIN adjustable door frame



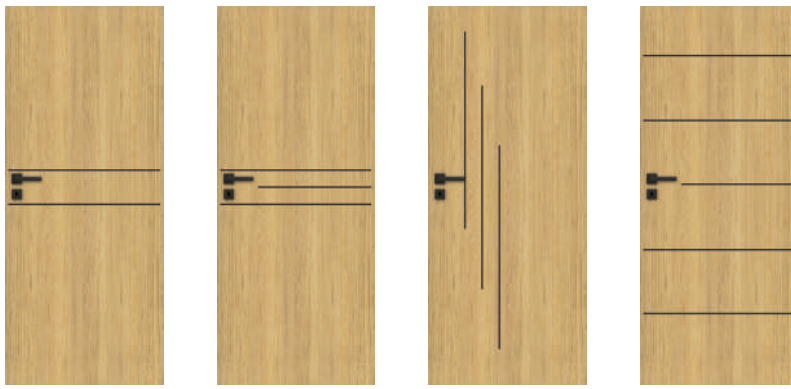

VERSION **W1 / VD1** **W2 / VD2** **W4 / VD4** **W5 / VD5**

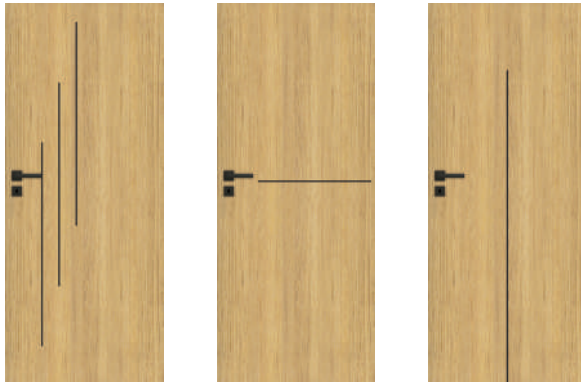

VERSION **W6 / VD6** **W7 / VD7** **W8 / VD8**

COLOURS

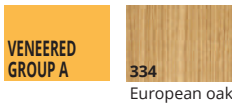

DOOR FRAMES

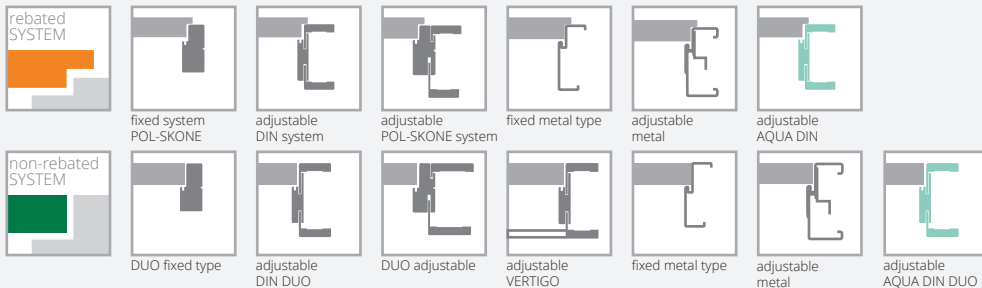

EQUIPMENT

STANDARD			
single-point lock, spacing: 72 mm, silver colour (rebated sys.) or magnetic (non-rebated sys.) mortise key-operated lock (spacing: 90 mm), for cylinder (spacing: 85 mm) or bathroom privacy lock (spacing: 90 mm)		change of the DUO hinge colour to black (non-rebated system)	
hinges: type K – for DIN system door frame, type C – for wooden door frame, type M – door leaf for metal door frame or hidden DUO nickel satin ("60"- "70" – 2 pcs, "80"- "90" – 3 pcs)		change of the DUO lock colour to black (non-rebated system)	
for door leaf with a door closer and DIN or metal door frame, use type T hinges in the quantity of "60"- "80" – 3 pieces, "90"- "100" – 4 pcs. (replacement of standard hinges for type T hinge for an extra charge)		reinforcement for door closer	
aluminium decors in the colour of black		bottom rail and stile set protected against excessive moisture (except door leaves with ventilation undercut)	
version W8: no possibility to use ventilation slot or ventilation grill		door lower by 50 mm (rebated sys.)	without an extra charge
ADDITIONAL (available at an extra charge)		door lower by 55 mm (non-rebated sys.)	without an extra charge
size "100"	+20%	door higher by 50 mm or 100 mm (third hinge required at an extra charge)	+10%
REVES (reverse rebate) system		door higher by 150 mm or 200 mm (third hinge required at an extra charge)	+20%
recuperation trim	without an extra charge	ventilation undercut (p. 245)	
solid chipboard in-fill (third hinge recommended)		door leaf edging in the colour of black	without an extra charge
third hinge in the door leaf			
type C for width "60"- "80"			
type K for width "60"- "80"			
type M for width "60"- "80"			
concealed DUO type for width "60"- "70"			
type T hinge in the colour of black (rebated sys.)			

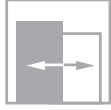
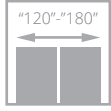
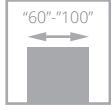

for door leaves with ventilation option



SEMPRE



- **robust wooden frame-based structure**
- **colours** from LAMISTONE CPL and SILKSTONE **surfaces**
- leaves are available with a one-sided **magnetic board** (Z/AZ) and a **one-sided mirror** (WL Z, WL A/Z)
- adjustable type K, type C or adjustable Duo hinge



glazing



laminated VSG 22.1 glass pane in the colour of black: available at an extra charge

SEMPRE door, W02 pattern, DIN SYSTEM adjustable door frame



INTERIOR DOORS RAIL AND STILE TYPE LAMINATED



SEMPRE door, W02 pattern (door on the left), DIN SYSTEM adjustable door frame, W02A pattern (door on the right), POL-SKONE fixed door frame



VERSION **W00 / V01** **W01 / V1SD** **W04 / V4SM** **W05 / V4SD** board* Z A/Z mirror* WLZ WLA/Z **W02P / V02** **W02 / V2S5** **W02S1 / V2S1** **W02S2 / V2S2**



VERSION **W02S3 / V2S3** **W02S4 / V2S4** **W02A / V2SA** **W03P / V03** **W03 / V3S5** **W03S1 / V3S1** **W03S2 / V3S2** **W03S3 / V3S3** **W03S4 / V3S4** **W03A / V3SA**



VERSION **W06 / V05** **W07 / V06** **W05 VERSE / V6SD**

* Z, WLZ - board/mirror on the hinge side, A/Z, WLA/Z - board/mirror on the side opposite to the hinge side

COLOURS



DOOR FRAMES

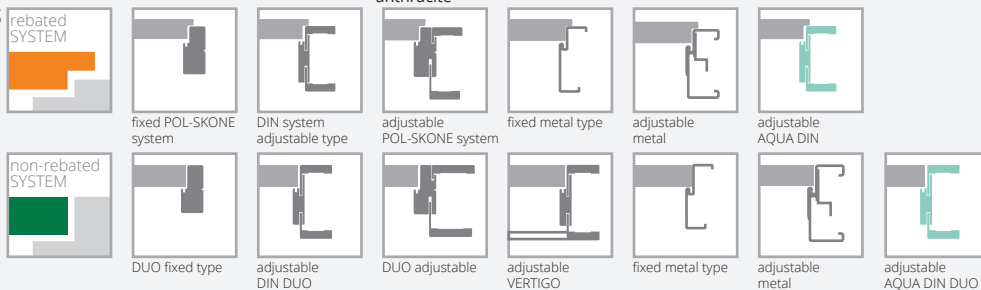

EQUIPMENT

STANDARD		
white/brown/graphite or transparent 4 mm glass		
W01, W05 tempered 4 mm glass		
pattern W00, W06, W07, panel thickness: 12 mm		
single-point lock, spacing: 72 mm (rebated sys.) or magnetic (non-rebated sys.) mortise lock, for key (spacing: 90 mm), for cylinder (spacing: 85 mm) or for bathroom privacy lock (spacing: 90 mm)		
hinges: type K brushed nickel - for DIN system door frame, type C brushed nickel - for wooden door frame, type M - for metal door frame or hidden DUO nickel satin ("60"- "80" - 2 pcs, "90" - 3 pcs)		
not available with a door closer		
not available with a drop seal		
version W05 VERSE - only applicable to width "70" - "100"		
ADDITIONAL (available at an extra charge)		
size "100"	+20%	
recuperation trim (only standard height)	+10%	
third hinge in the door leaf: type C for width "60"- "80" type K for width "60"- "80" type M for width "60"- "80" concealed DUO type for width "60"- "70"		
door lower by 50 mm (rebated sys.) (except WLZ, WLA/Z)		without an extra charge
door lower by 55 mm (non-rebated sys.) (except WLZ, WLA/Z)		without an extra charge
door higher by 50 mm or 100 mm (third hinge required for an extra charge) (except WLZ, WLA/Z, W05 VERSE)		+10%
ventilation undercut (p. 245)		
laminated VSG 22.1 glass, black (only applicable to 1 glass pane): version W02 version W03		
transparent 4 mm thick tempered glass		+10%

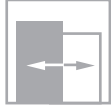
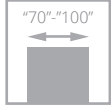

for door leaves with ventilation option

FORTIMO

NEW COLOURS



- **robust wooden frame structure**
- **colours** from LAMISTONE CPL and SILKSTONE **surfaces**
- door leaf stiles - vertical wood grain, board - vertical wood grain
- **tempered glass pane** in the colour of white matt, brown, graphite or transparent glass pane, 4 mm thick

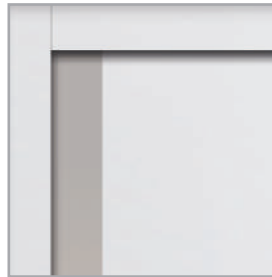

FORTIMO door, W01S1 pattern, DIN SYSTEM adjustable door frame

glazing



INTERIOR DOORS RAIL AND STILE TYPE LAMINATED



FORTIMO door, W01S1 pattern, DIN SYSTEM adjustable door frame



VERSION **W01 / V01** **W01S1 / V1S** **W03 / V02** **W03S1 / V2S**

COLOURS



DOOR FRAMES

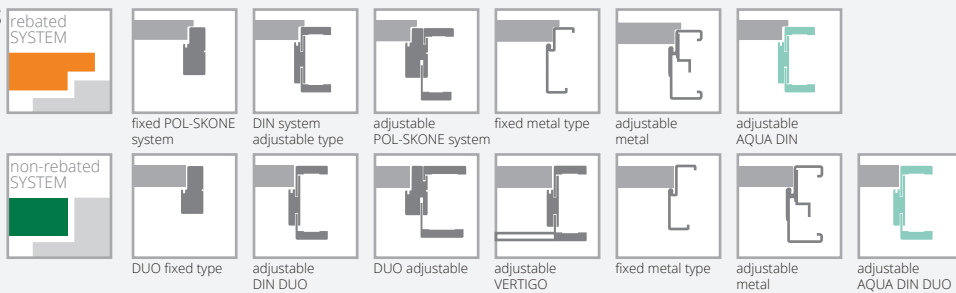

EQUIPMENT

STANDARD	white matt 4 mm thick tempered glass	third hinge in the door leaf: type C for width "70"- "80" type K for width "70"- "80" type M for width "70"- "80" concealed DUO type for width "70"- "80"
	single-point lock, spacing: 72 mm (rebated sys.) or magnetic (non-rebated sys.) mortise lock, for key (spacing: 90 mm), for cylinder (spacing: 85 mm) or for bathroom privacy lock (spacing: 90 mm)	door lower by 50 mm (rebated sys.) without an extra charge
	hinges: type K - for DIN system door frame, type C - for wooden door frame, type M - for metal door frame or hidden DUO nickel satin ("70"- "80" - 2 pcs, "90" - 3 pcs)	door lower by 55 mm (non-rebated sys.) without an extra charge
	not available with a door closer	ventilation undercut (p. 245)
ADDITIONAL (available at an extra charge)	size "100" +20%	laminated VSG 22.1. matt or transparent glass
	size "60" (only W01, W01S1) without an extra charge	laminated VSG 22.1 glass, black
	recuperation trim (only standard height) +10%	brown, graphite or transparent 4 mm thick tempered glass +10%

MONA

NEW
COLOURS



for door leaves with ventilation option



- **robust wooden frame-based structure**
- **colours** from LAMISTONE CPL **surface**
- board with vertical wood grain, panel in the colour of black (versions: W01, W02), black laminated glass pane (versions: W01S1, W02S2)
- safe laminated VSG 22.1 glass pane in the colour of black



board in the colour of black



black pane

MONA door, W02 pattern, DIN SYSTEM DUO adjustable door frame



INTERIOR DOORS RAIL AND STILE TYPE LAMINATED



MONA door, W02 pattern, DIN SYSTEM DUO adjustable door frame



VERSION **W01 / V01** with black board **W02 / V02** with black board **W01S1 / V1S** with black glass pane **W02S2 / V2S** with black glass pane

COLOURS

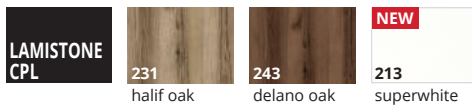

DOOR FRAMES

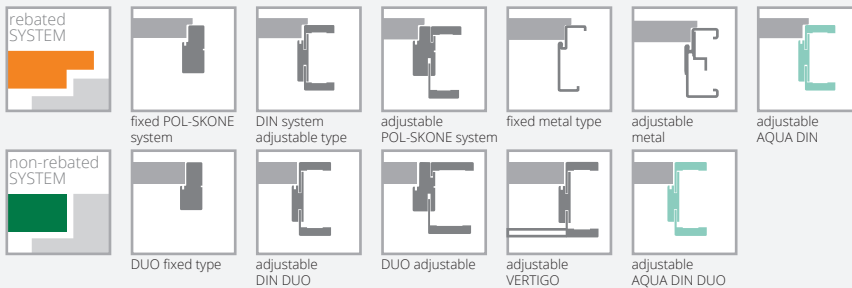

EQUIPMENT

STANDARD		
laminated non-transparent 4.2 mm thick black VSG 22.1 glass		third hinge in the door leaf:
single-point lock, spacing: 72 mm (rebated sys.) or magnetic (non-rebated sys.) mortise lock, for key (spacing: 90 mm), for cylinder (spacing: 85 mm) or for bathroom privacy lock (spacing: 90 mm)		type C for width "70"- "80"
hinges: type K - for DIN door frame, type C - for wooden door frame; type M - for metal door frame or hidden DUO nickel satin ("60"- "80" - 2 pcs, "90" - 3 pcs)		type K for width "70"- "80"
		type M for width "70"- "80"
		hidden DUO silver for a width of "70"- "80"
		hidden DUO black for a width of "70"- "80"
		door lower by 50 mm (rebated sys.)
		without an extra charge
		door lower by 55 mm (non-rebated sys.)
		without an extra charge
ADDITIONAL (available at an extra charge)		door lower by 50 mm (rebated sys.)
size "100"	+20%	ventilation undercut (p. 245)
size "60" and "60"+ "60" (versions W01, W01S1 only)	without an extra charge	sliding in-wall, on-wall, Premium system
recuperation trim (only standard height)	+10%	p. 238-243

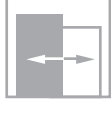
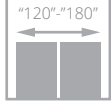

INVERNO

NEW COLOURS



- **robust structure - wooden rail and stile set**
- stable **solid board in-fill**
- **colours** from LAMISTONE CPL, SILKSTONE and UNIT MAT PLUS **surfaces**
- adjustable type K, type C hinge and adjustable DUO hinge



INVERNO door, 01 pattern, DIN SYSTEM adjustable door frame

moulding profile



INTERIOR DOORS RAIL AND STILE TYPE LAMINATED



INVERNO door, 00 pattern, DIN SYSTEM adjustable door frame



VERSION	00 / V01	0SD / V1SD	01 / V02	01SD / V2SD
LAMISTONE/ SILKSTONE				
UNI MAT PLUS				

COLOURS

LAMISTONE CPL		289 grey		213 superwhite
		276 Polish oak		
UNI MAT PLUS		640 graphite		641 titano
		642 white		643 beige
		644 black		
		645 lava		646 stone
		647 indigo		648 moss
		649 sage		

DOOR FRAMES

SYSTEM of reverse rebate							

EQUIPMENT

STANDARD	versions 0SD, 01SD: 4 mm thick tempered white matt glass	third hinge in the door leaf: type C for width "60"- "80" type K for width "60"- "80" type M for width "60"- "80" concealed DUO type for width "60"- "80"	
	single-point lock, spacing: 72 mm (rebated sys.) or magnetic (non-rebated sys.) mortise lock, for key (spacing: 90 mm), for cylinder (spacing: 85 mm) or for bathroom privacy lock (spacing: 90 mm)	change of standard DUO hinge to the colour of white or black (for 1 piece)	
	hinges: type K - for DIN system door frame, type C - for wooden door frame, type M - for metal door frame or hidden DUO nickel satin ("60"- "80" - 2 pcs, "90" - 3 pcs)	reinforcement for door closer	
	for door leaf with a door closer and DIN or metal door frame, use type T hinges in the quantity of "60"- "80" - 3 pieces, "90"- "100" - 4 pcs. (replacement of standard hinges for type T hinge for an extra charge)	bottom rail and stile set protector against excessive moisture (except door leaves with ventilation undercut)	
	rebated sys., black colour 644: silver hinges, black lock non-rebated sys., black colour 644: hinges and lock in the colour of black	door lower by 50 mm or 100 mm (rebated sys.)	without an extra charge
	not available with transparent glass pane	door lower by 55 mm or 100 mm (non-rebated sys.)	without an extra charge
ADDITIONAL (available at an extra charge)	size "100" (glazing decoration as in "90")	door higher by 50 mm or 100 mm (third hinge required at an extra charge)	+10%
	REVES system (reversed rebate) (versions: 00, 01) (above the ZW4 range, the door opening angle is 88°)	door higher by 150 mm or 200 mm (third hinge required at an extra charge)	+20%
	recuperation trim	ventilation undercut (p. 245)	
			without an extra charge

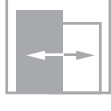

NOSTRE

NEW COLOURS



- **robust structure - wooden rail and stile set**
- stable **solid board in-fill**
- **colours** from LAMISTONE CPL and SILKSTONE **surfaces**
- adjustable type K, type C hinge and adjustable DUO hinge



NOSTRE door, 03 pattern, DIN SYSTEM adjustable door frame

NOSTRE door leaf decorative moulding



INTERIOR DOORS RAIL AND STILE TYPE LAMINATED



NOSTRE door, 03 pattern, DIN SYSTEM adjustable door frame



VERSION **00 / V01** **OSD / V1SD** **01 / V02** **01SM / V2SM** **01SD / V2SD**



VERSION **02 / V03** **02S1 / V3S1** **02S3 / V3S3** **03 / V04** **03SD / V4SD**

COLOURS



DOOR FRAMES

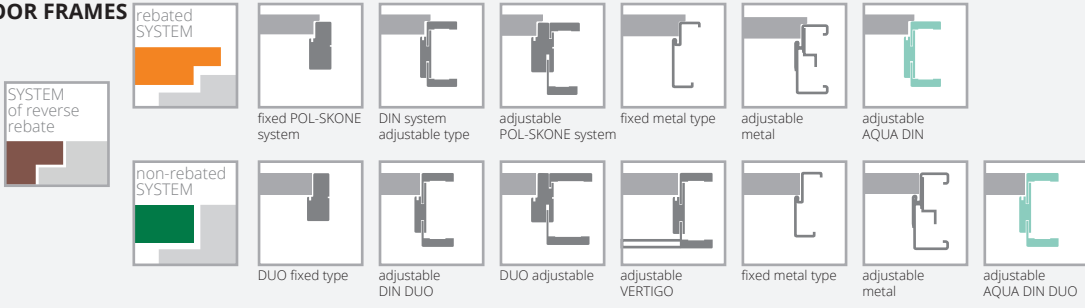

EQUIPMENT

STANDARD		
white matt glass, thickness: 4 mm		third hinge in the door leaf:
versions OSD, 01SD, 03SD: 4 mm thick tempered white matt glass		type C for width "60"- "80"
single-point lock, spacing: 72 mm (rebated sys.)		type K for width "60"- "80"
or magnetic (non-rebated sys.) mortise lock, for key (spacing: 90 mm), for cylinder (spacing: 85 mm) or for bathroom privacy lock (spacing: 90 mm)		type M for width "60"- "80"
hinges: type K - for DIN system door frame, type C - for wooden door frame, type M - for metal door frame ("60"- "80" - 2 pcs., "90" - 3 pcs.) or hidden DUO nickel satin ("60"- "70" - 2 pcs., "90" - 3 pcs)		concealed DUO type for width "60"- "80"
for door leaf with a door closer and DIN or metal door frame, use type T hinges in the quantity of "60"- "80" - 3 pieces, "90"- "100" - 4 pcs. (replacement of standard hinges for type T hinge for an extra charge)		reinforcement for door closer
ADDITIONAL (available at an extra charge)		bottom rail and stile set protector against excessive moisture (except door leaves with ventilation undercut)
size "100" (glazing decoration as in "90")	+20%	door lower by 50 mm or 100 mm (rebated sys.)
REVES system (reversed rebate) (versions: 00, 01, 02, 03) (above the ZW4 range, the door opening angle is 88°)		without an extra charge
recuperation trim	without an extra charge	door lower by 55 mm or 100 mm (non-rebated system)
		without an extra charge
		door higher by 50 mm or 100 mm (third hinge required at an extra charge)
		+10%
		door higher by 150 mm or 200 mm (third hinge required at an extra charge)
		+20%
		ventilation undercut (p. 245)

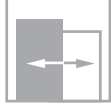
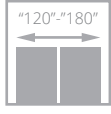
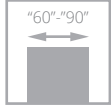

for door leaves with ventilation option

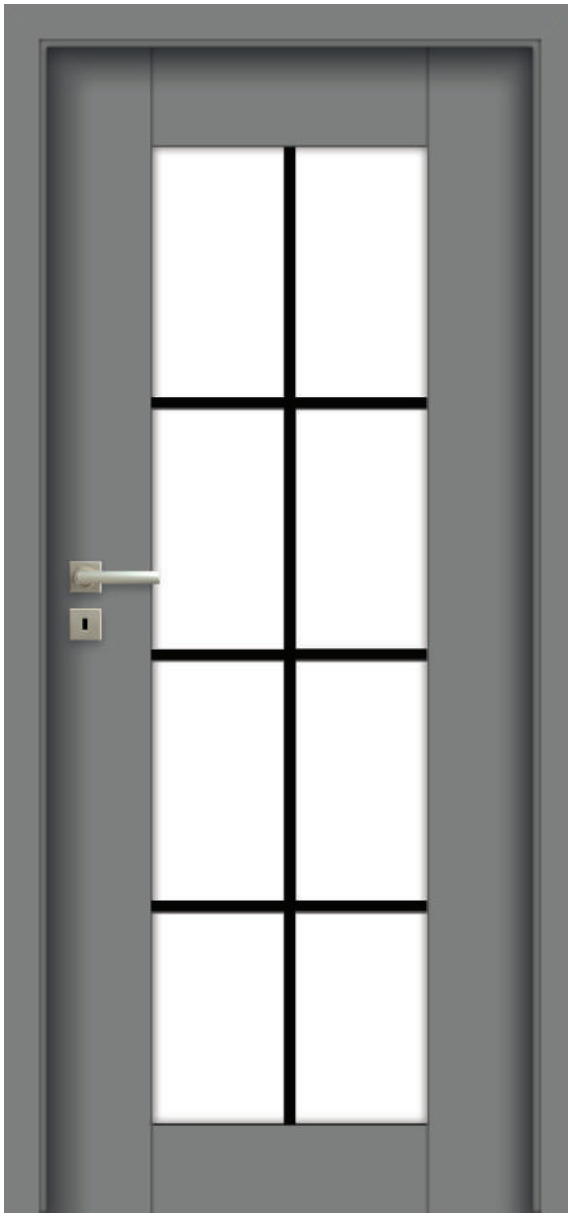

SEDO

NEW PATTERNS

NEW COLOURS



- **robust structure of the rail and stile set** made of high quality MDF
- **rich palette of colours of UNI MAT PLUS surface** with silky tactile experience and special fingerprint-proof coating



SEDO door, W01S8 pattern, DIN SYSTEM adjustable door frame

muntin bar profile



SEDO door, W03 pattern, DIN adjustable door frame

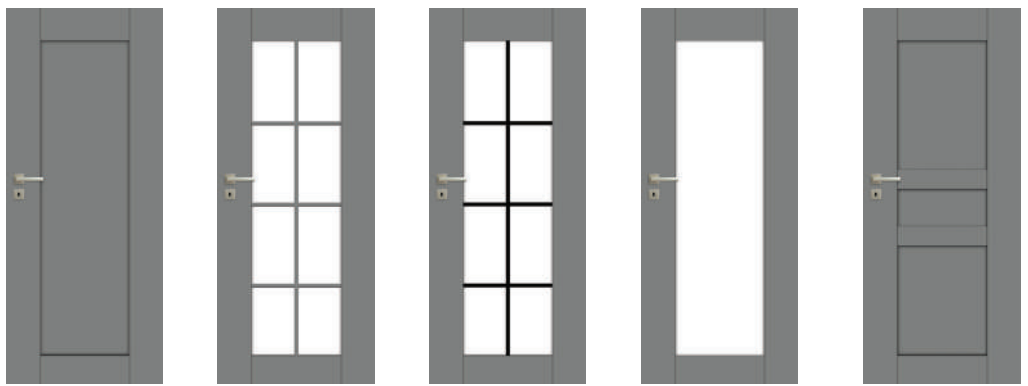

VERSION	W00 / V01	W01S8 / V1S8	W01S8 black muntins	W01 / V1SD	W02 / V02
height standard					

height 2140 mm (non-rebated)

height 2240 mm (non-rebated)



VERSION	W03 / V03	W04 / V04
height standard		

height 2140 mm (non-rebated)

height 2240 mm (non-rebated)

COLOURS

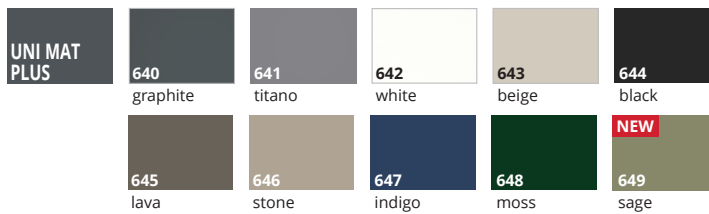

DOOR FRAMES

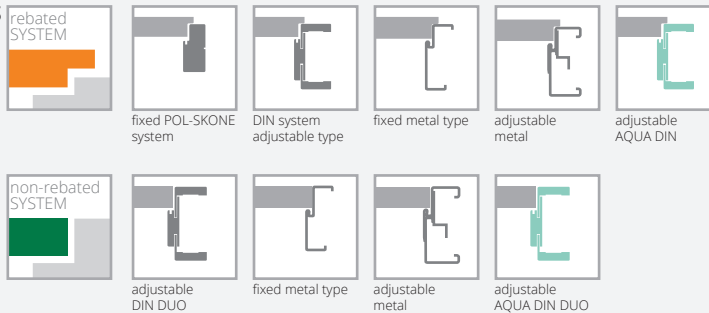

EQUIPMENT

STANDARD
versions: W00, W02, W03, W04: 12 mm thick panel version W01: tempered 4 mm thick white matt glass pane version W01, W01S8: tempered transparent or white matt 4 mm thick glass pane VSG 22.1, VSG 33.1 laminated glass pane cannot be used
single-point lock, spacing: 72 mm (rebated sys.) or magnetic (non-rebated sys.) mortise lock, for key (spacing: 90 mm), for cylinder (spacing: 85 mm) or for bathroom privacy lock (spacing: 90 mm) black 644, rebated sys.: lock in the colour of black, hinges in the colour of brushed nickel black 644, non-rebated sys.: lock and hinges in the colour of black
hinges: type B – for DIN system door frame, type C – for metal door frame or hidden DUO nickel satin ("60"-90" – 3 pcs) black 644: hidden DUO hinge in the colour of black
not available with an electric door strike

ADDITIONAL (available at an extra charge)	
recuperation trim (only standard height)	+10%
door lower by 50 mm (rebated sys.)	without an extra charge
door lower by 55 mm (non-rebated sys.)	without an extra charge
ventilation undercut	
version W01S8: muntin bars in the colour of black	without an extra charge

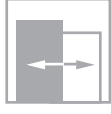
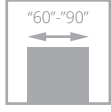

for door leaves with ventilation option

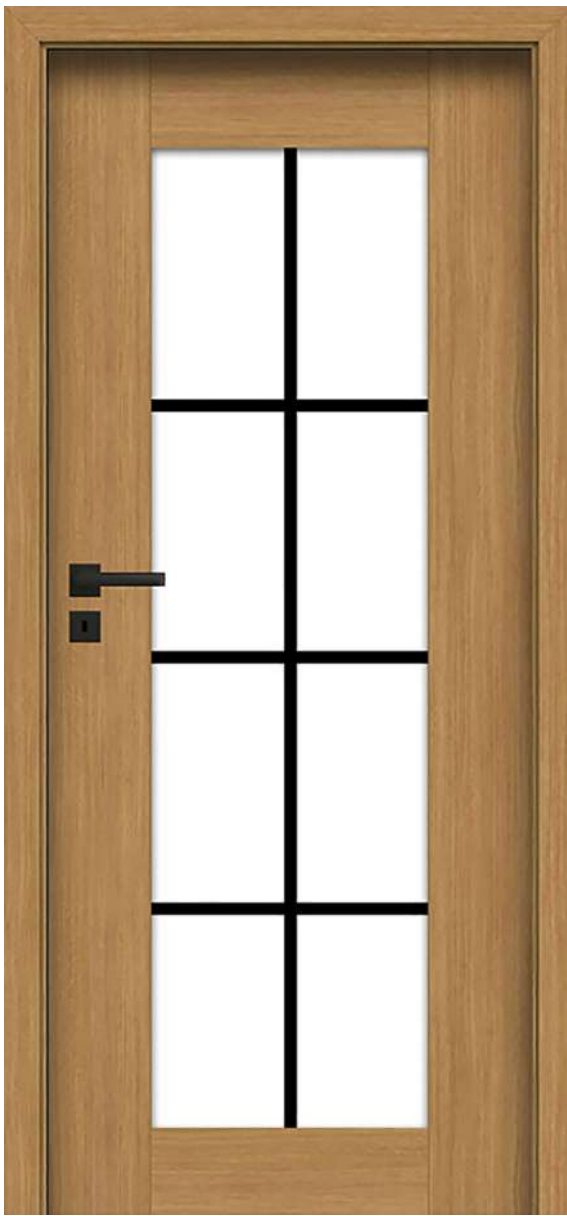

SAMOS

NEW

NEW COLOURS

- **robust structure of the rail and stile set** made of high quality MDF
- **stiles** with a thickness of 40 mm
- **rails** with a thickness of 35 mm
- **muntin bars** in the colour of door leaf or black

SAMOS door, V158 pattern, DIN SYSTEM adjustable door frame

INTERIOR DOORS RAIL AND STILE TYPE LAMINATED



SAMOS door, V155 pattern, DIN adjustable door frame



VERSION V01 V1S6 V1S8 V1S1 V1S5 V1S3

COLOURS

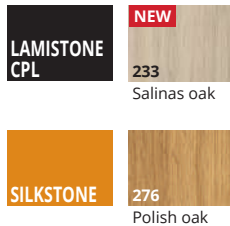

DOOR FRAMES

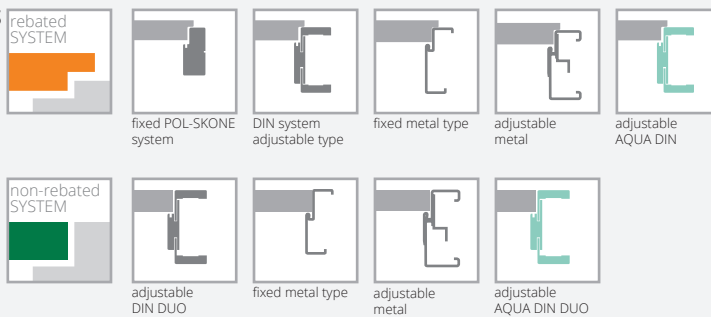

EQUIPMENT

STANDARD	ADDITIONAL (available at an extra charge)	
40 mm thick MDF stiles; 35 mm thick rails covered with CPL 0.15 laminate from LAMISTONE, SILKSTONE collections	recuperation trim (only standard height)	+10%
pattern V01 12 mm thick MDF panel covered with CPL 0.15 LAMISTONE, SILKSTONE laminated finish, vertical wood grain	door lower by 50 mm (rebated sys.)	without an extra charge
patterns V1S6, V1S8, V1S1, V1S5, V1S3 tempered 4 mm thick glass pane, white matt or translucent	door lower by 55 mm (non-rebated sys.)	without an extra charge
single-point white zinc-coated mortise lock, spacing: 72 mm (rebated sys.), magnetic (non-rebated sys.) mortise lock in the colour of nickel satin, for key (spacing: 90 mm), for cylinder (spacing: 85 mm) or for bathroom privacy lock (spacing: 90 mm)	ventilation undercut	
hinge: type B for DIN system door frame, type D - for wooden door frame, type M - for metal door frame or hidden DUO nickel satin ("60"- "90" - 9 pcs, "90" - 3 pcs)		
hidden DUO hinge, nickel satin - 3 pcs ("60"- "90")		
not available with a door closer		
not available with a drop seal		
VSG 22.1 and VSG 33.1 laminated glass pane cannot be used		
not available with an electric door strike		

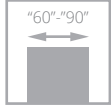

for leaves with ventilation option



MODO door, W00 pattern, DIN SYSTEM adjustable door frame

MODO

NEW COLOURS

- **robust structure** – rail and stile sets made of high quality MDF
- **rails and stiles** are of the same thickness of 40 mm
- MDF rail and stile set covered with **UNI MAT PLUS, LAMISTONE, SILKSTONE surface**
- 12 mm thick MDF panel covered with **UNI MAT PLUS, LAMISTONE, SILKSTONE surface**
- **spatial** decorative moulding



moulding profile

INTERIOR DOORS RAIL AND STILE TYPE LAMINATED



MODO door, W00 pattern, DIN adjustable door frame















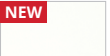



VERSION **W00 / V01** **W01 / V1SD** **W02 / V02** **W03 / V03**

height
standard





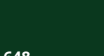



height 2140 mm
(non-rebated)

height 2240 mm
(non-rebated)

COLOURS

LAMISTONE CPL	 250 terra oak	 289 grey	 531 anthracite	 NEW 213 superwhite	
	 230 gran oak	 276 Polish oak	 295 Royal merbau		
UNI MAT PLUS	 640 graphite	 641 titano	 642 white	 643 beige	 644 black
	 645 lava	 646 stone	 647 indigo	 648 moss	 NEW 649 sage

DOOR FRAMES

rebated SYSTEM	 DIN system adjustable type	 fixed metal type	 adjustable metal	 adjustable AQUA DIN
		 adjustable DIN DUO	 fixed metal type	 adjustable metal

EQUIPMENT

STANDARD
 pattern W01 - white matt 4 mm thick tempered glass pane
 single-point white zinc-coated mortise lock, spacing: 72 mm (rebated system), in the colour of UNI MAT PLUS black 644 single-point mortise lock in the colour of black, spacing: 72 mm (rebated system) or magnetic mortise lock in the colour of nickel satin (non-rebated system) for key (spacing: 90 mm), for cylinder (spacing: 85 mm) or for bathroom privacy lock (spacing: 90 mm) in the colour of UNI MAT PLUS black 644 magnetic mortise lock in the colour of black (non-rebated system) for key (spacing: 90 mm), for cylinder (spacing: 85 mm) or for bathroom privacy lock (spacing: 90 mm)
 silver hinges: type B - for DIN system door frame, type M - for the metal door frame or hidden DUO nickel satin ("60"-90" - 3 pcs), in the colour of UNI MAT PLUS black 644 DUO hidden hinges in the colour of black
 not available with a door closer
 not available with a drop seal
 VSG 22.1; VSG 33.1 laminated glass pane is not available
 not available with an electric door strike

ADDITIONAL (available at an extra charge)	
recuperation trim (only standard height)	+10%
door lower by 50 mm (rebated sys.)	without an extra charge
door lower by 55 mm (non-rebated sys.)	without an extra charge
ventilation undercut	
transparent 4 mm tempered thick glass	+10%

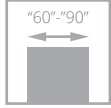

for leaves with ventilation option



VERI

NEW COLOURS

- **robust structure** – rail and stile sets made of high quality MDF
- **rails and stiles** are of the same thickness of 40 mm
- MDF rail and stile set covered with **UNI MAT PLUS, LAMISTONE, SILKSTONE surface**
- 12 mm thick MDF panel covered with **UNI MAT PLUS, LAMISTONE, SILKSTONE surface**
- **spatial** decorative moulding



moulding profile



chamfered connection of rails and stiles

VERI door, W02 pattern, DIN SYSTEM adjustable door frame



VERI door, W00 pattern, DIN DUO adjustable door frame

INTERIOR DOORS RAIL AND STILE TYPE LAMINATED





VERSION **W00 / V01** **W01 / V1SD** **W02 / V02** **W03 / V03**

height
standard

height 2140 mm
(non-rebated)

height 2240 mm
(non-rebated)

COLOURS

LAMISTONE CPL					
	250 terra oak	289 grey	531 anthracite	213 superwhite	
SILKSTONE					
	230 gran oak	276 Polish oak	295 Royal merbau		
UNI MAT PLUS	640 graphite	641 titano	642 white	643 beige	644 black
	645 lava	646 stone	647 indigo	648 moss	649 sage

DOOR FRAMES

rebated SYSTEM					
	DIN system adjustable type	fixed metal type	adjustable metal	adjustable AQUA DIN	
	non-rebated SYSTEM				
		adjustable DIN DUO	fixed metal type	adjustable metal	adjustable AQUA DIN DUO

EQUIPMENT

STANDARD	ADDITIONAL (available at an extra charge)
pattern W01 - white matt 4 mm thick tempered glass pane	recuperation trim (only standard height) +10%
single-point white zinc-coated mortise lock, spacing: 72 mm (rebated system), in the colour of UNI MAT PLUS black 644 single-point mortise lock in the colour of black, spacing: 72 mm (rebated system) or magnetic mortise lock in the colour of nickel satin (non-rebated system) for key (spacing: 90 mm), for cylinder (spacing: 85 mm) or for bathroom privacy lock (spacing: 90 mm) in the colour of UNI MAT PLUS black 644 magnetic mortise lock in the colour of black (non-rebated system) for key (spacing: 90 mm), for cylinder (spacing: 85 mm) or for bathroom privacy lock (spacing: 90 mm)	door lower by 50 mm (rebated sys.) without an extra charge
silver hinges: type B - for DIN system door frame, type M - for the metal door frame or hidden DUO nickel satin ("60"- "90" - 3 pcs), in the colour of UNI MAT PLUS black 644 DUO hidden hinges in the colour of black	door lower by 55 mm (non-rebated sys.) without an extra charge
not available with a door closer	ventilation undercut
not available with a drop seal	transparent 4 mm tempered thick glass +10%
VSG 22.1; VSG 33.1 laminated glass pane is not available	
not available with an electric door strike	

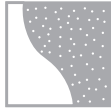
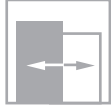
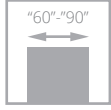

for leaves with ventilation option



EGRO door, W00 pattern, DIN SYSTEM adjustable door frame

EGRO

NEW COLOURS

- **robust structure** – rail and stile sets made of high quality MDF
- **rails and stiles** are of the same thickness of 40 mm
- MDF rail and stile set covered with **UNI MAT PLUS, LAMISTONE, SILKSTONE surface**
- 16 mm thick MDF panel covered with **UNI MAT PLUS, LAMISTONE, SILKSTONE surface**
- **three-dimensional** 16 mm thick panel



three-dimensional panel

INTERIOR DOORS RAIL AND STILE TYPE LAMINATED



EGRO door, W00 pattern, DIN adjustable door frame



VERSION **W00 / V01** **W01 / V1SD** **W02 / V02** **W03 / V2SD** **W04 / V03** **W05 / V3SD**

height
standard

height 2140 mm
(non-rebated)

height 2240 mm
(non-rebated)

COLOURS

LAMISTONE CPL	250 terra oak	289 grey	531 anthracite	NEW 213 superwhite	
	230 gran oak	276 Polish oak	295 Royal merbau		
UNI MAT PLUS	640 graphite	641 titano	642 white	643 beige	644 black
	645 lava	646 stone	647 indigo	648 moss	NEW 649 sage

DOOR FRAMES

rebated SYSTEM	DIN system adjustable type	fixed metal type	adjustable metal	adjustable AQUA DIN	
	non-rebated SYSTEM	adjustable DIN DUO	fixed metal type	adjustable metal	adjustable AQUA DIN DUO

EQUIPMENT

STANDARD

pattern W01, W02, W03 - white matt 4 mm thick tempered glass pane
 pattern W00, W02, W04 - 16 mm thick three-dimensional panel
 single-point white zinc-coated mortise lock, spacing: 72 mm (rebated system), in the colour of UNI MAT PLUS black 644 single-point mortise lock in the colour of black, spacing: 72 mm (rebated system) or magnetic mortise lock in the colour of nickel satin (non-rebated system) for key (spacing: 90 mm), for cylinder (spacing: 85 mm) or for bathroom privacy lock (spacing: 90 mm) in the colour of UNI MAT PLUS black 644 magnetic mortise lock in the colour of black (non-rebated system) for key (spacing: 90 mm), for cylinder (spacing: 85 mm) or for bathroom privacy lock (spacing: 90 mm)

silver hinges: type B - for DIN system door frame,
 type M - for the metal door frame or hidden DUO nickel satin ("60"-90" - 3 pcs), in the colour of UNI MAT PLUS black 644
 DUO hidden hinges in the colour of black

not available with a door closer
 not available with a drop seal
 VSG 22.1; VSG 33.1 laminated glass pane is not available
 not available with an electric door strike

ADDITIONAL (available at an extra charge)	
recuperation trim (only standard height)	+10%
door lower by 50 mm (rebated sys.)	without an extra charge
door lower by 55 mm (non-rebated sys.)	without an extra charge
ventilation undercut	
transparent 4 mm tempered thick glass	+10%

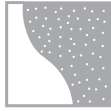
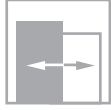
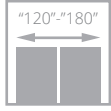
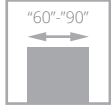

for leaves with ventilation option



ESTO

NEW

NEW COLOURS



- **robust structure** - made of high quality MDF
- **stiles** with a thickness of 40 mm
- **35 mm thick rails** (upper and lower)
- 22 mm thick boards

ESTO door, V355 pattern, DIN SYSTEM adjustable door frame

INTERIOR DOORS RAIL AND STILE TYPE LAMINATED



ESTO door, V355 pattern, DIN adjustable door frame



VERSION **V03** **V3S1** **V3S2**



VERSION **V3S3** **V3S4** **V3S5**

COLOURS

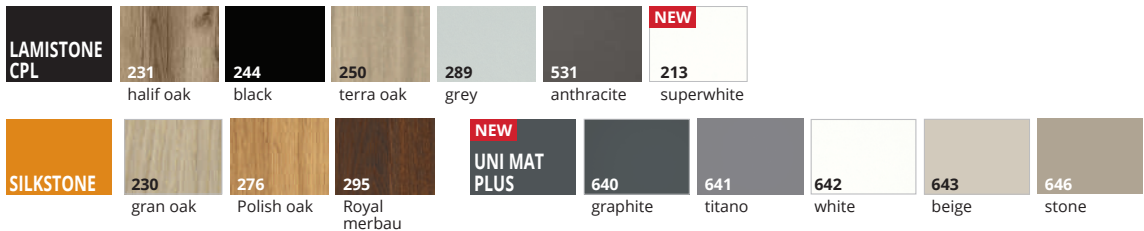

DOOR FRAMES

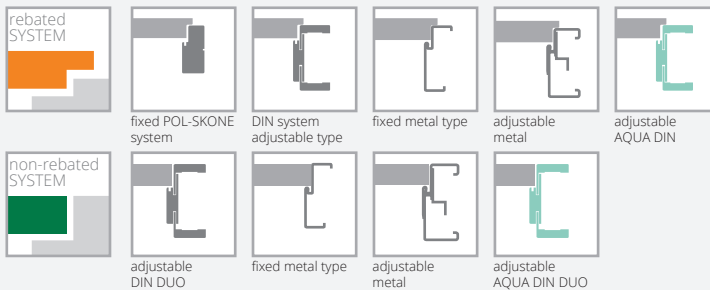

EQUIPMENT

STANDARD	ADDITIONAL (available at an extra charge)	
robust structure made of high quality MDF	recuperation trim (only standard height)	+10%
40 mm thick stiles	door lower by 50 mm (rebated sys.)	without an extra charge
35 mm thick rails (upper and lower)	door lower by 55 mm (non-rebated sys.)	without an extra charge
22 mm thick boards	ventilation undercut	
white matt glass, thickness: 4 mm	transparent 4 mm tempered thick glass	+10%
single-point white zinc-coated mortise lock, spacing: 72 mm (rebated system), in the colour of black 244 single-point mortise lock in the colour of black, spacing: 72 mm (rebated system) or magnetic mortise lock in the colour of nickel satin (non-rebated system) for key (spacing: 90 mm), for cylinder (spacing: 85 mm) or for bathroom privacy lock (spacing: 90 mm) in the colour of black 244 magnetic mortise lock in the colour of black (non-rebated system) for key (spacing: 90 mm), for cylinder (spacing: 85 mm) or for bathroom privacy lock (spacing: 90 mm)		
silver hinges: type B – for DIN system door frame, type M – for metal door frame or hidden DUO nickel satin ("60"- "90" – 3 pcs)		
black 244: DUO hinge in the colour of black		
not available with an electric door strike		

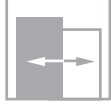
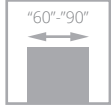

for leaves with ventilation option



ARCO door, W03P pattern, DIN SYSTEM adjustable door frame

ARCO



- **robust structure** of rail and stile set made of high quality MDF
- FSC® Mix Certificate only available upon Customer's request



rail and stile set - vertical wood grain, boards and panel - horizontal wood grain



boards, glazing



available at extra charge: **laminated VSG 22.1 glass in the colour of black**



The mark of responsible forestry

ARCO with FSC® Mix Certificate only available upon Customer's request



ARCO door, W02 pattern (door on the left and on the right), DIN adjustable door frame



VERSION W02P / V02 W2S / V2S2 W02 / V2S5 W2D / V1SD W03P / V03 W3S / V3S2 W03 / V3S5 W5P / V4S2 W5S / V4S4 W05 / V4S3

ECO TOP
LAMISTONE
SILKSTONE



VERSION W06 / V05 W6S1 / V5S1 W6S2 / V5S2 W6S3 / V5S3 W07 / V06 W07S1 / V6S1 W07S3 / V6S3 W08 / V07 W08S1 / V7S1 W08S4 / V7S4

ECO TOP
LAMISTONE
SILKSTONE

COLOURS



DOOR FRAMES

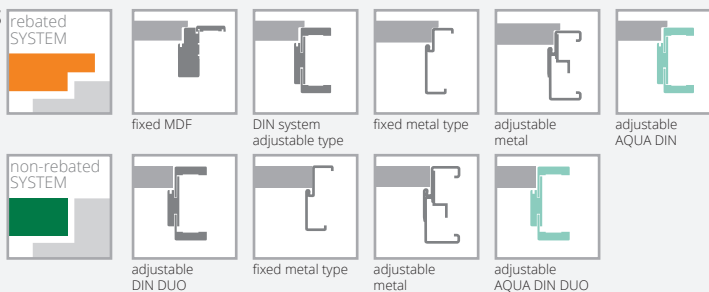

EQUIPMENT

STANDARD	ADDITIONAL (available at an extra charge)
white/brown matt or transparent 4 mm thick glass	recuperation trim (only standard height) +10%
patterns W2D, W5S, W05, W6S1, W6S2, W6S3	door lower by 50 mm (rebated sys.) without an extra charge
standard – tempered glass pane	door lower by 55 mm (non-rebated sys.) without an extra charge
single-point lock, spacing: 72 mm (rebated sys.) or magnetic mortise lock (non-rebated system) for key (spacing: 90 mm), for cylinder (spacing: 85 mm) or for bathroom privacy lock (spacing: 90 mm)	ventilation undercut (p. 245)
hinges: type B – for DIN system door frame, type D - for MDF door frame, type M – for metal door frame or hidden DUO nickel satin (*60°-90° – 3 pcs)	laminated VSG 22.1 glass pane, white or transparent (only applicable to 1 glass pane): version W02, W08 version W03
not available with a door closer	transparent 4 mm tempered thick glass +10%
not available with a drop seal	laminated VSG 22.1 glass pane, black (only applicable to 1 glass pane): version W02, W08 version W03
not available with an electric door strike	

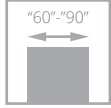

for leaves with ventilation option



UNITO

NEW

NEW COLOURS

- **robust structure** of rail and stile set made of high quality MDF
- **rich colour palette** of the UNI MAT PLUS surface offers a silky tactile experience and has a special fingerprint-proof coating
- **stiles** with a thickness of 40 mm
- **rails** with a thickness of 35 mm
- 16 mm thick boards



rail / stile



boards, glazing



available at extra charge: **laminated VSG 22.1 glass in the colour of black**

UNITO door, W03P pattern, DIN SYSTEM adjustable door frame

INTERIOR DOORS RAIL AND STILE TYPE LAMINATED



UNITO door, W02 pattern, DIN adjustable door frame



VERSION **W02P / V02** **W2S / V2S2** **W02 / V2S5** **W03P / V03** **W3S / V3S2** **W03 / V3S5**

COLOURS

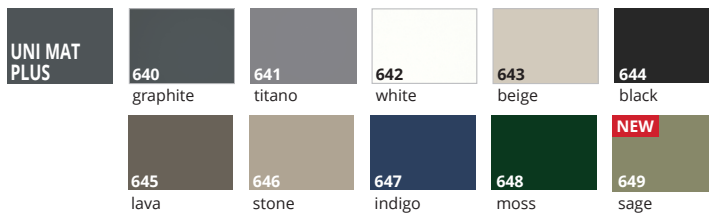

DOOR FRAMES

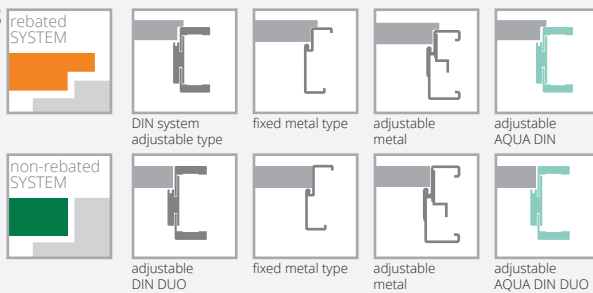

EQUIPMENT

STANDARD	
40 mm thick MDF stiles; 35 mm thick rails covered with UNI AT PLUS surface	Colour 642 white: rebated system – hinges: silver colour; lock in the colour of white non-rebated system – hinges and lock in the colour of white
16 mm thick boards made of MDF and covered with UNI MAT PLUS surface	not available with a door closer
white matt or brown matt 4 mm thick glass pane patterns W2S/V2S2; W02/V2S5; W3S/V3S2; W03/V3S5	not available with a drop seal
pattern W02P/V02 – 4 mm thick panel in the colour of door leaf with the UNI MAT PLUS surface	not available with an electric door strike
single-point mortise lock, spacing: 72 mm, for key WK, WB, WC or magnetic mortise lock, for key (spacing: 90 mm), for cylinder (spacing: 85 mm) or for bathroom privacy lock (spacing: WC)	ADDITIONAL (available at an extra charge)
hinges: type B for DIN door frame, type D for MDF door frame, type M for metal door frame or non-rebated hidden DUO hinge 3 pcs ("60"-/90")	door lower by 50 mm (rebated sys.) without an extra charge
Colour 644 black: rebated system – hinges: silver colour; lock in the colour of black non-rebated system – hinges and lock in the colour of black	door lower by 55 mm (non-rebated sys.) without an extra charge
	ventilation undercut
	recuperation trim (only standard heights) +10%
	laminated VSG 22.1 glass, black
	version W02
	version W03

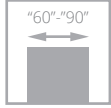

for leaves with ventilation option



FIORI

NEW COLOURS

- **robust structure** – rails and stiles **made of high quality MDF**
- rails and stiles **are of the same thickness of 40 mm**



special chamfer on the stile and rail connection



available at extra charge: **laminated VSG 22.1 glass in the colour of black**

FIORI door, W02S2P pattern, DIN SYSTEM adjustable door frame

INTERIOR DOORS RAIL AND STILE TYPE LAMINATED



FIORI door, W02 pattern, DIN adjustable door frame



VERSION **W02 / V4S4** **W02P / V04** **W02S2P / V4S2**

COLOURS

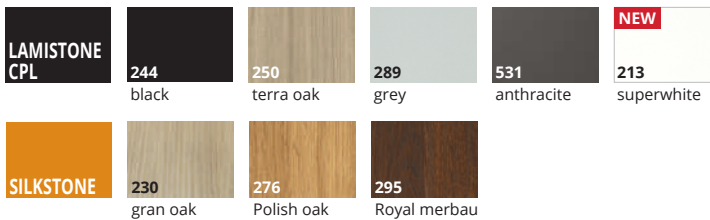

DOOR FRAMES

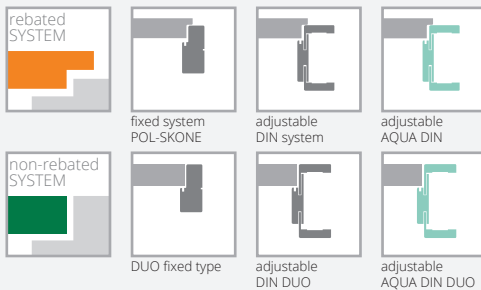

EQUIPMENT

STANDARD	
white/brown matt or transparent 4 mm thick glass	change of standard DUO hinge to the colour of white or black (to 1 piece)
single-point lock, spacing: 72 mm (rebated sys.) or magnetic (non-rebated sys.) mortise key-operated lock (spacing: 90 mm), for cylinder (spacing: 85 mm) or bathroom privacy lock (spacing: 90 mm)	door lower by 50 mm (rebated sys.) without an extra charge
hinges: type B – for DIN system door frame, type D – for wooden door frame or hidden DUO nickel satin ("60"-“90" – 3 pcs)	door lower by 55 mm (non-rebated sys.) without an extra charge
not available with a door closer	ventilation undercut (p. 245)
not available with a drop seal	laminated VSG 22.1 glass, frosted or transparent (only applicable to 1 glass pane)
not available with an electric door strike	transparent 4 mm tempered thick glass +10%
ADDITIONAL (available at an extra charge)	laminated VSG 22.1 glass, black colour (only applicable to 1 glass pane): version W02, W02S2P
recuperation trim (only standard height) +10%	change of colour of DUO lock to the colour of golden gloss
lock in the colour of black, rebated system	

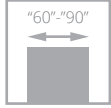

for leaves with ventilation option



ARIA door, W01 pattern, DIN SYSTEM adjustable door frame

ARIA

NEW

NEW COLOURS

COMPOSE YOUR ARIA

feel free to make **your own selection** of the **colours** of muntin bars

- robust **structure** – rail and stile set made of high **quality MDF**
- 30 mm thick muntin bars applied by gluing, covered with **UNI MAT PLUS or SILKSTONE surface**
- panel thickness: 12 mm
- rails and stiles **are of the same thickness of 40 mm**
- rich colour palette of the UNI MAT PLUS surface offers a **silky tactile experience** and has a special **fingerprint-proof** coating



muntin bar

INTERIOR DOORS RAIL AND STILE TYPE LAMINATED



ARIA door, W03 pattern, DIN adjustable door frame



VERSION **W01 / V01** **W01S* / V1SD** **W02 / V02** **W02S* / V2SD** **W03 / V03** **W03S* / V3SD**

*glazed version



COLOURS

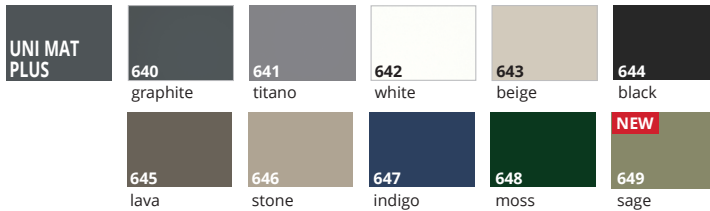

DOOR FRAMES

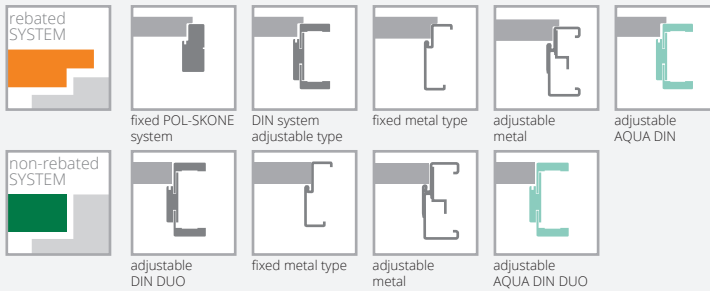

EQUIPMENT

STANDARD	ADDITIONAL (available at an extra charge)
pattern W01S, W02S, W03S - white matt 4 mm thick tempered glass pane	recuperation trim (only standard height) +10%
robust structure of the rail and stile set made of high quality MDF	door lower by 50 mm (rebated sys.) without an extra charge
12 mm thick MDF panel covered with UNI MAT PLUS surface	door lower by 55 mm (non-rebated sys.) without an extra charge
rails and stiles are of the same thickness of 40 mm	ventilation undercut
30 mm thick muntin bars applied by gluing, covered with UNI MAT PLUS or SILKSTONE surface	transparent 4 mm tempered thick glass +10%
single-point white zinc-coated mortise lock, spacing: 72 mm (rebated system), in the colour of UNI MAT PLUS black 644 single-point mortise lock in the colour of black, spacing: 72 mm (rebated system) or magnetic mortise lock in the colour of nickel satin (non-rebated system) for key (spacing: 90 mm), for cylinder (spacing: 85 mm) or for bathroom privacy lock (spacing: 90 mm) in the colour of UNI MAT PLUS black 644 magnetic lock in the colour of black (non-rebated system), mortise type, for key (spacing: 90 mm), for cylinder (spacing: 85 mm) or for bathroom privacy lock (spacing: 90 mm)	
silver hinges: type B - for DIN system door frame, type M - for the metal door frame or hidden DUO nickel satin ("60"-90" - 3 pcs), in the colour of UNI MAT PLUS black 644	
DUO hidden hinges in the colour of black	

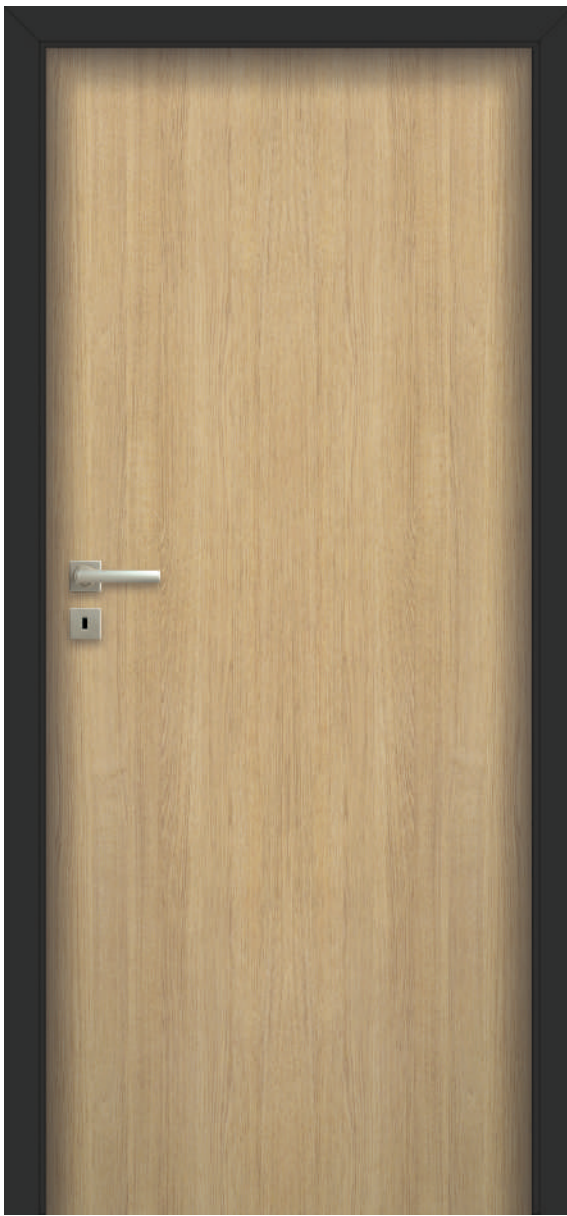
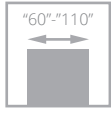

LOFTY

NEW COLOURS

- **robust structure - wooden rail and stile set**
- stable **solid board in-fill**
- adjustable, reinforced type T hinge and adjustable type DUO hinge in the colour of black

LOFTY door, W00 pattern, DIN SYSTEM adjustable door frame, black colour

INTERIOR DOORS PANELLED LAMINATED



LOFTY door, W00 pattern, DIN adjustable door frame, black colour 244



SET PRICE
 =
DOOR LEAF PRICE
 +
DIN/DIN DUO DOOR FRAME PRICE
(244 or 644 black)
 or
HARMONY DOOR FRAME PRICE
(BLACK RAL 9005)
 or
METAL DOOR FRAME PRICE

VERSION **W00 / V00**

- ECO TOP
- LAMISTONE CPL
- SILKSTONE
- VENEERED GROUP A
- VENEERED GROUP D







COLOURS

ECO TOP	 121 oak	 141 Salinas oak	 160 sonoma oak	 161 halif oak
SILKSTONE	 230 gran oak	 276 Polish oak		
LAMISTONE CPL	 231 halif oak	 243 delano oak	 250 terra oak	
VENEERED GROUP A	 334 European oak	VENEERED GROUP D	 311 bright oak*	 313 classic oak
				 460 macassar

* colours available subject to consultation with the Sales Department

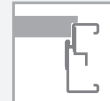
DOOR FRAMES

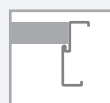

rebated SYSTEM				
	DIN system adjustable type	fixed metal type	adjustable metal	adjustable AQUA DIN
non-rebated SYSTEM				
	adjustable DIN DUO system	fixed metal type	adjustable metal	adjustable AQUA DIN DUO

EQUIPMENT

STANDARD	single-point lock in the colour of black, spacing: 72 mm (rebated sys.) or magnetic (non-rebated sys.) mortise lock, for key (spacing: 90 mm), for cylinder (spacing: 85 mm) or for bathroom privacy lock (spacing: 90 mm)	reinforcement for door closer	without an extra charge
	hinges: type T - for metal door frame or hidden DUO in the colour of black ("60"- "80" - 2 pcs, 90" - 3 pcs)	bottom rail and stile set protected against excessive moisture (except door leaves with ventilation undercut)	
	for a door leaf with a door closer and DIN or metal door frame, use type T hinges in the quantity of "60"- "80" - 3 pieces, "90"- "110" - 4 pcs. (replacement of standard hinges for type T hinge for extra charge)	door lower by 50 mm or 100 mm (rebated sys.)	without an extra charge
ADDITIONAL (available at an extra charge)	size "100"	door higher by 50 mm or 100 mm (third hinge required at an extra charge)	+10%
	size "110"	door higher by 150 mm or 200 mm (third hinge required at an extra charge)	+20%
	REVES system (reversed rebate)	ventilation undercut (p. 245)	
	recuperation trim	door leaf edging in the colour of black	without an extra charge
	third hinge in the door leaf or adjustable pivot hinge (1 piece price):	ABS edge in the colour of black or Polish oak (except the REVES system)	without an extra charge
	type T black colour for width "60"- "80"		
	hidden DUO black colour for width "60"- "80"		

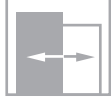
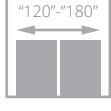

ZENN

NEW

NEW COLOURS



- new unique CPL 0.15 surface with a texture of linen fabric interwoven with metallic shine
- robust structure - wooden rail and stile set
- stable perforated board in-fill
- safe tempered glass pane, transparent or black matt or white matt



ZENN door, W00 pattern, DIN adjustable door frame

surface texture

INTERIOR DOORS PANELLED LAMINATED



ZENN door, A01 pattern, DIN adjustable door frame

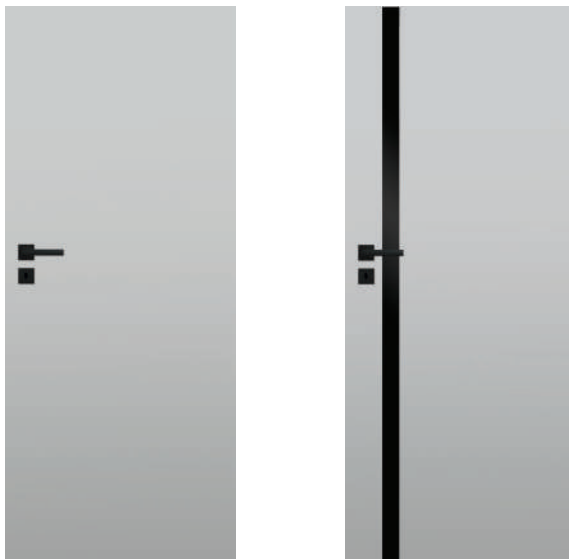

VERSION **W00 / V01**

A01 / V1SA



filo colour – stone edging

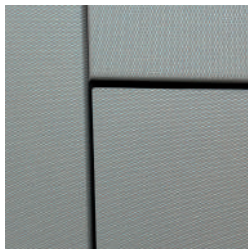

fibra colour – lava edging

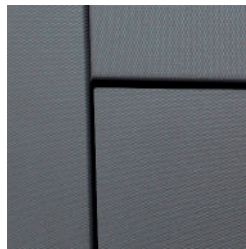

lino colour – titano edging

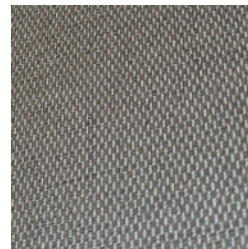

new **unique** CPL 0.15 surface with a texture of **linen fabric** interwoven with **metallic shine**

COLOURS



DOOR FRAMES

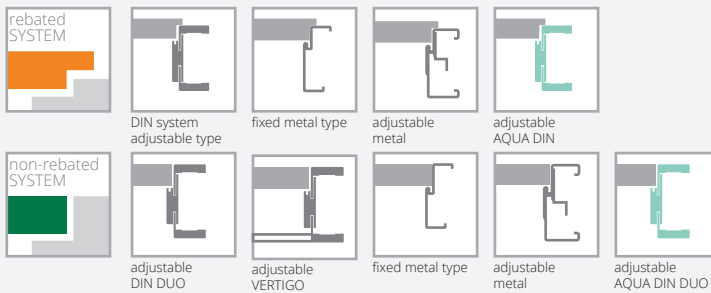

EQUIPMENT

STANDARD	ADDITIONAL (available at an extra charge)
pattern A01: laminated 8.4 mm thick VSG 44.2 glass pane in the colour of black matt	size "100" +20%
REBATED SYSTEM	solid chipboard in-fill (W00) (third hinge recommended in the door leaf at extra charge)
single-point mortise lock, spacing: 72 mm, for key (WK), for cylinder (WB) or bathroom privacy lock (WC) black colour	third hinge in the door leaf or adjustable pivot hinge (1 piece price):
type T hinge black colour ("60"- "80" – 2 pcs; "90" – 3 pcs)	type T for a width of "60"- "80"
NON-REBATED SYSTEM	concealed DUO type for a width of "60"- "80"
magnetic mortise lock for key (WK) - spacing: 90 mm, for bathroom privacy lock (WC) - spacing: 90 mm; for cylinder (WB) - spacing: 85 mm, black colour	bottom rail and stile set protected with ABS edging from excessive moisture (except door leaves with ventilation undercut and version A01) without an extra charge
non-rebated hidden hinges (DUO non-rebated system) - black ("60"- "80" – 2 pcs, "90" – 3 pcs)	ventilation undercut (except A01) (p. 245)
	ventilation undercut (A01 version)
	UNI MAT PLUS surface edge: filo colour – stone edging, fibra colour – lava edging, lino colour – titano edging without an extra charge
	sliding in-wall, on-wall, Premium system (except A01) p. 238-243

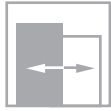
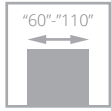

DECO door, 00 pattern, DIN SYSTEM adjustable door frame

DECO



- robust structure - wooden rail and stile set
- Surface covered with 0.2 mm, 0.5 mm or 0.7 mm thick CPL laminate resistant to scratching and chemicals
- door also available in **mechanical class III**
- adjustable type K, type C hinge and adjustable DUO hinge



spacer



glazing



DECO door, 05 pattern, DIN SYSTEM adjustable door frame



To obtain mechanical class III, you need to order the door leaf with a metal door frame, wooden door frame or adjustable DIN frame in mechanical class III. DIN door frame, strength class III, with a pine board reinforcement under the striker plate; angular striker plate - extra charge **+10%** added to the adjustable DIN frame price.

VERSION	00 / V00	02 / V2S	03SD / V3SD	04 / V4SD	05 / V5SD
----------------	-----------------	-----------------	--------------------	------------------	------------------

LAMINATED CPL 0.2 mm

LAMINATED CPL 0.2 mm
mechanical class III

COLOURS

SILKSTONE CPL 0.5 mm	976 Polish oak	993 Royal anthracite	994 Royal ash	995 Royal merbau	997 Royal nougat						
LAMINATED CPL 0.2 mm	820 white	222 grey	229 oak	821 anthracite	863 premium walnut	849 industry 3	225 terra oak	227 delano oak	844 black	280 halif oak *	228 segato walnut
LAMINATED CPL 0.5 mm*	945 white texture	252 oak	922 grey texture	926 anthracite texture	965 wenge	963 premium walnut	946 black texture	961 halif oak			
LAMINATED CPL 0.7 mm*	745 white texture	722 grey texture	779 oak	726 anthracite texture	765 wenge	763 premium walnut	746 black texture	761 halif oak			
LAMINATED HPL*					* available upon consultation with the Sales Department						

For door leaves with textured laminate, door frame surface with plain laminate.

DOOR FRAMES

SYSTEM of reversed rebate	rebated SYSTEM								
	non-rebated SYSTEM								

EQUIPMENT

STANDARD	white matt or transparent 4 mm thick glass white matt tempered glass (03SD version, door leaves of mechanical class III)	third hinge in door leaf or adjustable pivot hinge (price per 1 piece): type C for a width of "60"- "80" type K for width "60"- "80" type M for width "60"- "80" type T concealed DUO type for a width of "60"- "70"
	single-point lock, spacing: 72 mm (rebated sys.) or magnetic mortise lock (non-rebated system) for key (spacing: 90 mm), for cylinder (spacing: 85 mm) or for bathroom privacy lock (spacing: 90 mm); lock with stainless steel face plate (door leaves of mechanical class III)	rail and stile set (for do-it-yourself shortening to 50 mm)
	hinges: type K, silver - for DIN system door frame, type C, silver - for wooden door frame, type M - for metal door frame or hidden DUO nickel satin ("60"- "80" - 2 pcs, "90" - 3 pcs) hinges: type K (leaves: mechanical class III) - 3 pcs	rail and stile set (for do-it-yourself shortening to 90 mm)
	for a door leaf with a door closer and DIN or metal door frame, use type T hinges in the quantity of "60"- "80" - 3 pieces, "90"- "110" - 4 pcs. (replacement of standard hinges for type T hinge for extra charge)	reinforcement for door closer
ADDITIONAL (available at an extra charge)	size "100" (glazing decoration as in "90")	bottom rail and stile set protector against excessive moisture impact (except door leaves with ventilation undercut)
	size "110" (glazing decoration as in "90")	door lower by 50 mm or 100 mm (rebated sys.) without an extra charge
	REVES system (reversed rebate) (00 version)	door lower by 55 mm or 100 mm (non-rebated sys.) without an extra charge
	recuperation trim	non-standard height +10%
	CPL laminate 0.5 mm ("60" - "90") available at an extra charge*	door higher by 50 mm or 100 mm (third hinge required at an extra charge) +10%
	CPL laminate 0.7 mm ("60" - "90") available at an extra charge*	door higher by 150 mm or 200 mm (third hinge required at an extra charge) +20%
	CPL laminate 0.5 mm ("90+" - "110") available at an extra charge*	ventilation undercut (p. 245)
	CPL laminate 0.7 mm ("90+" - "110") available at an extra charge*	tempered glass: 02, 04, 05 versions
	SILKSTONE CPL 0.5 mm colours (spacer for glazed door leaves and door frame are made with the SILKSTONE surface)	transparent 4 mm tempered thick glass +10%
	perforated chipboard in-fill	edges in other colours - black, grey, graphite - are available
	solid chipboard in-fill (third hinge recommended)	ABS edging in the colour of black, white, titano, Polish oak or anthracite (except the REVES system) without an extra charge

* extra charge to standard door height

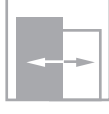
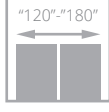
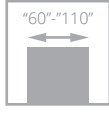

HAPTIC

NEW COLOURS

- **robust structure - wooden rail and stile set**
- **rich colour palette** of the UNI MAT PLUS surface offers a silky tactile experience and has a special fingerprint-proof coating
- adjustable type K, type C hinge and adjustable DUO hinge

HAPTIC door, 00 pattern, DIN adjustable door frame

INTERIOR DOORS PANELLED LAMINATED



HAPTIC door, 00 pattern, DIN adjustable door frame



VERSION **00 / V00** **02 / V2S** **04 / V4SD** **05 / V5SD** **03SD / V3SD**



ABS EDGING

without an extra charge

COLOURS

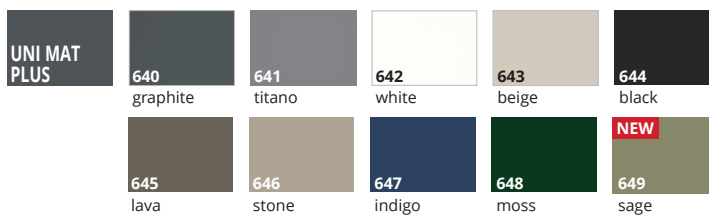

DOOR FRAMES

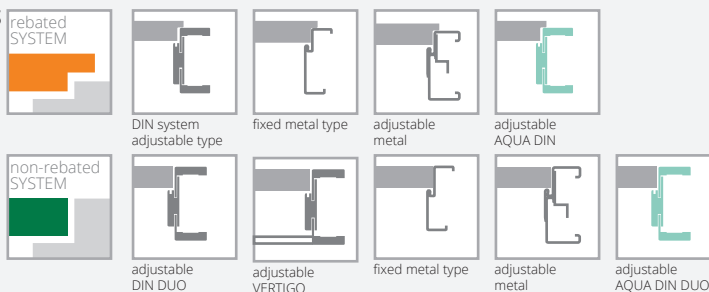

EQUIPMENT

STANDARD		
white/brown matt or transparent 4 mm thick glass pattern 03SD	rail and stile set (for do-it-yourself shortening to 50 mm)	
standard - 4 mm thick white/brown matt tempered glass pane	rail and stile set (for do-it-yourself shortening to 90 mm)	
single-point lock, spacing: 72 mm (rebated sys.) or magnetic mortise lock (non-rebated system) for key (spacing: 90 mm), for cylinder (spacing: 85 mm) or for bathroom privacy lock (spacing: 90 mm)	reinforcement for door closer	
hinges: type K silver – for DIN system door frame, type M – for metal door frame or hidden DUO nickel satin ("60"- "80" – 2 pcs, "90" - 3 pcs)	bottom rail and stile set protector against excessive moisture impact (except door leaves with ventilation undercut)	
for a door leaf with a door closer and DIN or metal door frame, use type T hinges in the quantity of "60"- "80" - 3 pieces, "90"- "110" - 4 pcs. (replacement of standard hinges for type T hinge for extra charge)	door lower by 50 mm or 100 mm (rebated sys.)	without an extra charge
ADDITIONAL (available at an extra charge)	door lower by 55 mm or 100 mm (non-rebated sys.)	without an extra charge
size "100" (glazing decoration as in "90")	door higher by 50 mm or 100 mm (third hinge required at an extra charge)	+10%
size "110" (glazing decoration as in "90")	door higher by 150 mm or 200 mm (third hinge required at an extra charge)	+20%
REVES system (reversed rebate) (00 version)	ventilation undercut (p. 245)	
recuperation trim	tempered glass (02, 04, 05 versions)	
perforated chipboard in-fill	transparent 4 mm thick tempered glass	+10%
solid chipboard in-fill (third hinge recommended)	ABS edging in the colour of black, white, titano, Polish oak or anthracite (except the REVES system)	without an extra charge
third hinge in the door leaf or adjustable pivot hinge (1 piece price):		
type K for width "60"- "80"		
type M for width "60"- "80"		
concealed DUO type for a width of "60"- "80"		
change of the DUO lock colour to black or golden gloss		

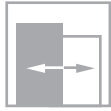
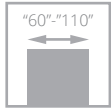

IMPULS door, W06 pattern, DIN SYSTEM adjustable door frame

IMPULS



- **robust structure - wooden rail and stile set**
- **rich colours** from LAMISTONE CPL or SILKSTONE **surfaces**
- adjustable type K, type C hinge and adjustable DUO hinge



moulding profile



door frame

INTERIOR DOORS PANELLED LAMINATED



IMPULS door, W13 pattern (door on the left), W01 pattern (door on the right), DIN SYSTEM adjustable door frame

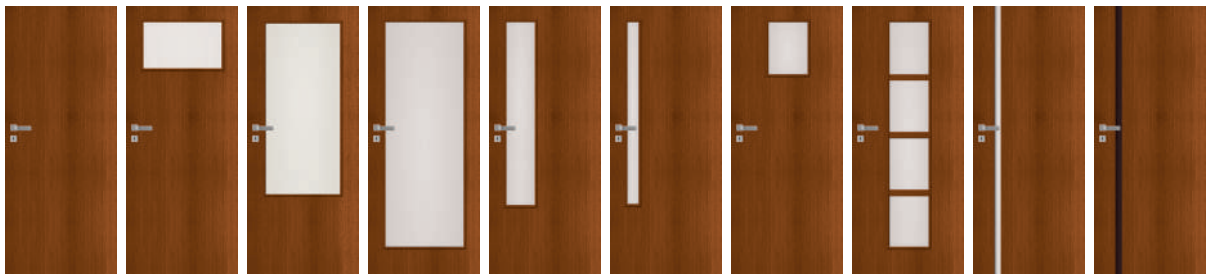

VERSION W01 / V00 W02 / V2S W03 / V3SD W05 / V1SD W06 / V4SD W07 / V5SD W12D1 / V6S1 W12 / V6S4 W13 / V1SA W14 / V1SA

SILKSTONE
LAMISTONE CPL
SILKSTONE CPL
0,5

COLOURS



DOOR FRAMES

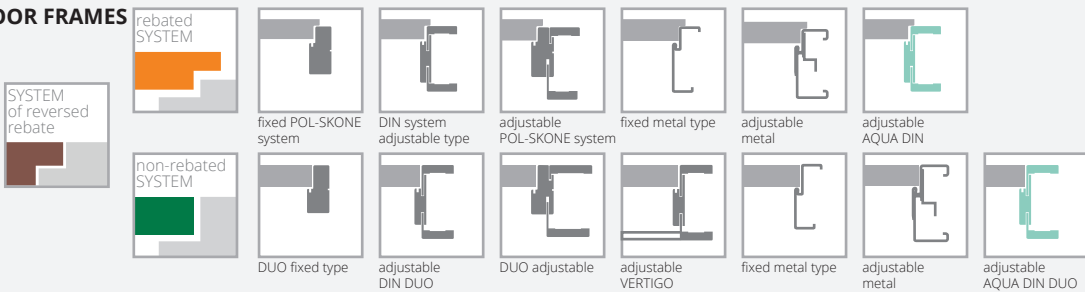

EQUIPMENT

STANDARD		
white/brown matt or translucent 4 mm thick glass white/brown matt tempered glass pattern W03, W05, version W13: white / brown matt 6 mm thick tempered glass version W14: laminated 8.5 mm thick VSG 44.2 glass in the colour of black		rail and stile set (for do-it-yourself shortening to 90 mm) (except versions W13, W14)
single-point lock, spacing: 72 mm (rebated sys.) or magnetic mortise lock (non-rebated system) for key (spacing: 90 mm), for cylinder (spacing: 85 mm) or for bathroom privacy lock (spacing: 90 mm)		reinforcement for a door closer (except versions W13, W14)
hinges: type K silver - for DIN system door frame, type C silver - for wooden door frame, type M - for metal door frame or hidden DUO nickel satin ("60"-80" - 2 pcs, "90" - 3 pcs)		bottom rail and stile set protector against excessive moisture (except door leaves with ventilation undercut) (except versions W13, W14)
for a door leaf with a door closer and DIN or metal door frame, use type T hinges in the quantity of "60"-80" - 3 pieces, "90"-110" - 4 pcs. (replacement of standard hinges for type T hinge for extra charge)		door lower by 50 mm or 100 mm (rebated sys.) (except versions W13, W14) without an extra charge
ADDITIONAL (available at an extra charge)		door lower by 55 mm or 100 mm (rebated sys.) (except versions W13, W14) without an extra charge
size "100" (glazing decoration as in "90")	+20%	door higher by 50 mm or 100 mm (third hinge required for an extra charge) (except versions W13, W14) +10%
size "110" (glazing decoration as in "90")	+40%	door higher by 150 mm or 200 mm (third hinge required for an extra charge) (except versions W13, W14) +20%
REVES system (reversed rebate) (versions W01, W13, W14)		versions: W13, W14 door lower 1970 mm (rebated sys.), 1985 mm (non-rebated sys.) without an extra charge
recuperation trim (except versions W13, W14)	without an extra charge	versions: W13, W14 door higher by 100 mm (third hinge required for an extra charge) +10%
perforated chipboard in-fill		versions: W13, W14 door higher by 200 mm (third hinge required for an extra charge) +20%
solid chipboard in-fill (third hinge recommended)		ventilation undercut (p. 245)
third hinge in the door leaf or adjustable pivot hinge (1 piece price):		sliding system (except versions W13, W14) p. 238-243
type C for a width of "60"-80"		tempered glass:
type K for width "60"-80"		versions: W02, W12D1
type M for width "60"-80"		versions: W06, W07, W12
concealed DUO type for a width of "60"-80"		transparent 4 mm thick tempered glass +10%
DUO lock colour change to black or golden gloss		ABS edging in the colour of black, white, titano, Polish oak or anthracite (except the REVES system) without an extra charge
rail and stile set (for do-it-yourself shortening to 50 mm) (except versions W13, W14)		

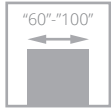

MAESTO door, W01 pattern, DIN adjustable door frame

MAESTO



- **robust structure - wooden rail and stile set**
- **rich colour palette of the UNI MAT PLUS surface** offers a silky tactile experience and has a special fingerprint-proof coating
- **aluminium 25 mm thick decors in the colour of copper matt or black matt**
- decorative 30 mm thick moulding in the colour of the leaf
- stable perforated board in-fill



decorative moulding profile



dedicated handle in the colour of copper



INTERIOR DOORS PANELLED LAMINATED



MAESTO door, W02 pattern, DIN adjustable door frame



VERSION **W01 / VD1** **W02 / VD2** **W03 / VD3**

COLOURS

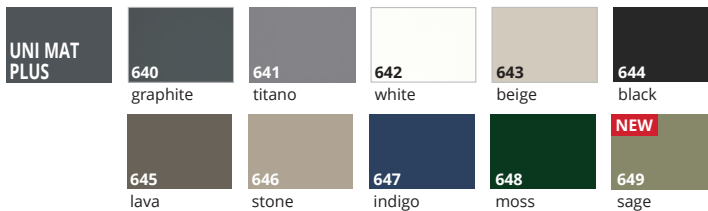

DOOR FRAMES

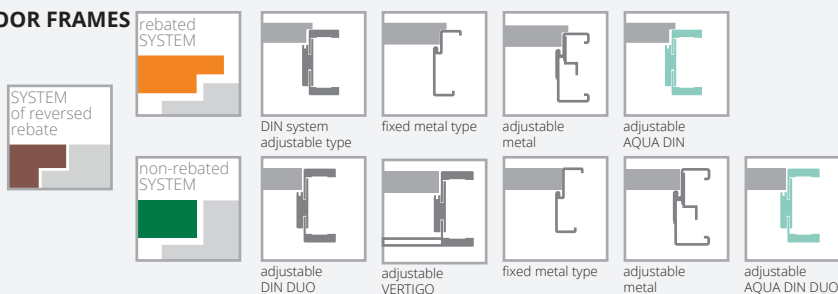

EQUIPMENT

	STANDARD – REBATED SYSTEM	ADDITIONAL (available at an extra charge)
	aluminium decors, black colour/copper; single-point mortise lock, spacing: 72 mm, for key (WK), for cylinder (WB) or bathroom privacy lock (WC) black colour/white colour 642: lock in the colour of white	size "100" +20%
	aluminium decors, black colour/copper: type T hinge black colour ("60"-80" – 2 pcs; "90" – 3 pcs) white colour 642: hinges in the colour of white	REVES system (reversed rebate)
		third hinge in the door leaf or adjustable pivot hinge (1 piece price): type T for a width of "60"-80" concealed DUO type for a width of "60"-80"
	STANDARD – NON-REBATED SYSTEM	ventilation undercut
	aluminium decors, black colour/copper; magnetic mortise lock, for key (spacing: 90 mm), for bathroom privacy lock (spacing: 90 mm) for cylinder (spacing: 85 mm) black colour white colour 642: lock in the colour of white	bottom rail and stile set protector against excessive moisture impact (except door leaves with ventilation undercut)
	aluminium decors, black colour/copper: DUO hidden hinge black colour ("60"-80" – 2 pcs; "90" – 3 pcs) white colour 642: hinges in the colour of white	sliding system
	STANDARD	p. 238-243
	it is possible to change the lock colour to silver, white – without an extra charge	
	REVES system (reversed rebate): because of the decorative moulding on the door leaf, the REVES system, from the ZW3 adjustment range, the door leaf maximum opening angle 80°	
	HARMONY (reverse rebate) system: because of the decorative moulding on the door leaf, the HARMONY ODW system, from the wall thickness 115 mm, the door leaf maximum opening angle 80°	



CREATO

NEW COLOURS

- **robust structure - wooden rail and stile set**
- stable in-fill **made of perforated board**
- **rich palette of colours of UNI MAT PLUS surface with silky tactile experience and special fingerprint-proof coating**
- **secure laminated VSG 44.2 glass pane in the colour of black or white**
- **reinforced type T or adjustable Duo hinge**



CREATO door, A02 pattern, DIN SYSTEM adjustable door frame

hidden white hinge - option

INTERIOR DOORS PANELLED LAMINATED



CREATO door, A01 pattern, DIN SYSTEM adjustable door frame

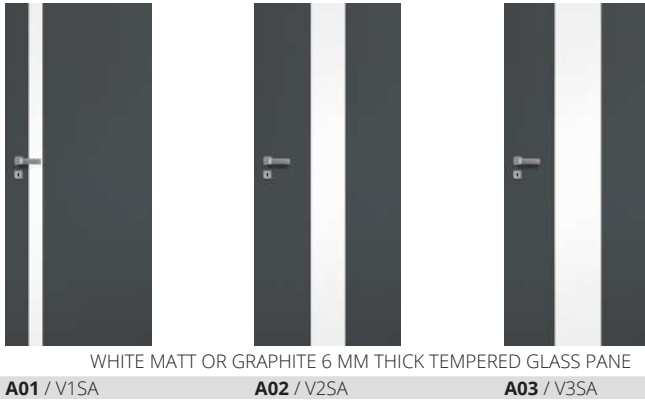

COLOURS

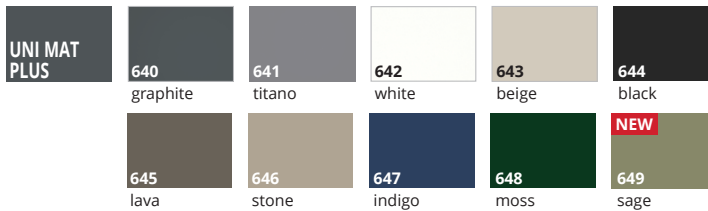

DOOR FRAMES

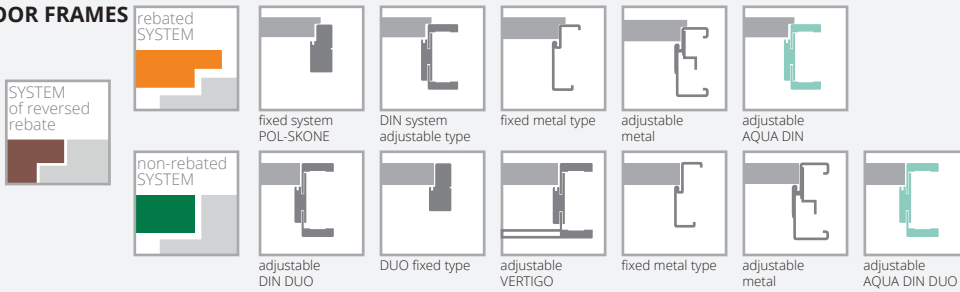

EQUIPMENT

STANDARD	laminated 44.2 glass in the colour of black, transparent or white matt (patterns A01 – 58 mm, A02 – 208 mm, A03 – 280 mm)* versions with laminated black glass pane: lock in the colour of black, type T or DUO hinges in the colour of black versions with laminated transparent or white matt glass pane: lock and hinges in the colour of silver
	single-point lock, spacing: 72 mm (rebated sys.) or magnetic (non-rebated sys.) mortise lock, for key (spacing: 90 mm), for cylinder (spacing: 85 mm) or for bathroom privacy lock (spacing: 90 mm)
	hinges: type T black - for DIN system and metal door frame, type C, D silver - for wooden frame ("60"- "80" – 2 pcs, "90" – 3 pcs) or hidden DUO black for non-rebated system ("60"- "70" – 2 pcs, "80"- "90" – 3 pcs)
	not available with a door closer
	lower rail and stile set protector from excessive moisture not available
	ADDITIONAL (available at an extra charge)
	size "100" +20%
	REVES system (reversed rebate)
	solid chipboard in-fill (third hinge recommended)

third hinge in the door leaf:	type D for width "60"- "80"	
	type C for a width of "60"- "80"	
	type T for a width of "60"- "80"	
	concealed DUO type for a width of "60"- "70"	
	change of standard type T hinge to the colour of black	
	change of standard DUO hinge to the colour of black	
	versions: A01, A02, A03 door lower by 50 mm (rebated sys.)	without an extra charge
	versions: A01, A02, A03 door lower by 55 mm (non-rebated sys.)	without an extra charge
	versions: A01, A02, A03 door higher by 100 mm (third hinge required for an extra charge)	+10%
	versions: A01, A02, A03 door higher by 200 mm (third hinge required for an extra charge)	+20%
	leaf edging in the colour of black (except the REVES system)	without an extra charge
	sliding system (except version A01)	p. 238-243
	ventilation undercut A01 with widths "60" - "100" (p. 245)	
	ventilation undercut A02, A03 with widths "70" - "100" (p. 245)	

*dimension tolerance +/- 2 mm

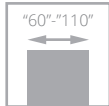

ETIUDA door, B1 pattern, DIN SYSTEM adjustable door frame

ETIUDA

- **robust structure - wooden rail and stile set**
- **colours** from LAMISTONE CPL oraz SILKSTONE **surfaces**
- **tempered 6 mm thick glass pane** in the colour of white matt or graphite
- decorative glazing beads the colour of silver or black
- adjustable type K, type C and adjustable type DUO hinge



aluminium decorative mouldings

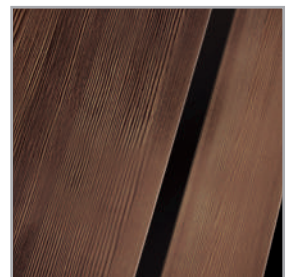

option: aluminium decorative mouldings in the colour of black

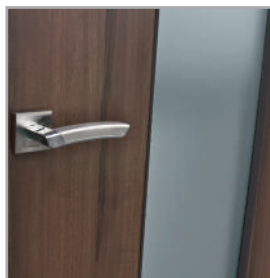

option: aluminium glazing beads in the colour of black

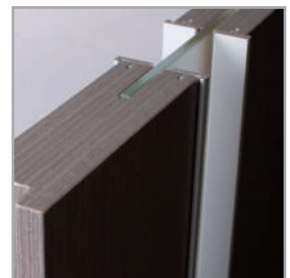

top door leaf edge without a rebate



ETIUDA door, B1 pattern (door on the left), A01 pattern (door on the right), POL-SKONE SYSTEM fixed door frame



VERSION **B0 / V00** **B1 / VD11** **A01 / V1SA** **A02 / V2SA** **A03 / V3SA**

COLOURS



DOOR FRAMES

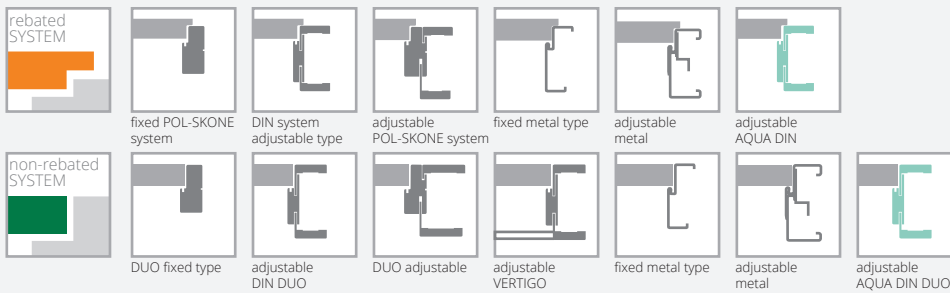

EQUIPMENT

STANDARD	
white/brown matt 6 mm thick tempered glass glass pane in the colour of black is unavailable	
glazing width in versions A01 – 54 mm; A02 – 205 mm, A03 – 276 mm*	
single-point lock, spacing: 72 mm (rebated sys.) or magnetic mortise lock (non-rebated system) for key (spacing: 90 mm), for cylinder (spacing: 85 mm) or for bathroom privacy lock (spacing: 90 mm)	
hinges: type K, silver - for DIN system door frame, type C, silver - for wooden door frame, type M - for metal door frame or hidden DUO nickel satin ("60"-80" – 2 pcs, "90" – 3 pcs)	
for a door leaf with a door closer and DIN or metal door frame, use type T hinges in the quantity of "60"-80" - 3 pieces, "90"-110" - 4 pcs. (replacement of standard hinges for type T hinge for extra charge)	
version B1: solid board in-fill	
ADDITIONAL (available at an extra charge)	
size "100"	+20%
size "110" (versions B0, B1 only)	+40%
perforated chipboard in-fill (version B0, A01, A02, A03)	
solid chipboard in-fill (version B0, A01, A02, A03) (third hinge recommended)	
third hinge in the door leaf or adjustable pivot hinge (1 piece price):	
type C for a width of "60"-80"	
type K for width "60"-80"	
type M for width "60"-80"	
concealed DUO type for a width of "60"-80"	
change of the DUO lock colour to black or golden gloss	
rail and stile set (for do-it-yourself shortening to 50 mm) (version B0 only)	
rail and stile set (for do-it-yourself shortening to 90 mm) (version B0 only)	
reinforcement for a door closer (except versions A01, A02, A03)	
bottom rail and stile set protector against excessive moisture (except leaves with ventilation undercut) (except versions A01, A02, A03)	
door lower by 50 mm or 100 mm (rebated sys.) (except versions A01, A02, A03)	without an extra charge
door lower by 55 mm or 100 mm (non-rebated sys.) (except versions A01, A02, A03)	without an extra charge
door higher by 50 mm or 100 mm (third hinge required at an extra charge) (except versions A01, A02, A03)	+10%
door higher by 150 mm or 200 mm (third hinge required at an extra charge) (except versions A01, A02, A03)	+20%
versions A01, A02, A03 door lower by 50 mm (rebated sys.)	without an extra charge
versions A01, A02, A03 door lower by 55 mm (non-rebated sys.)	without an extra charge
versions A01, A02, A03 door higher by 100 mm (third hinge required for an extra charge)	+10%
versions A01, A02, A03 door higher by 200 mm (third hinge required for an extra charge)	+20%
ventilation undercut (version B0, B1 only) (p. 245)	
ventilation undercut A01 with widths "60" - "100" (p. 245)	
ventilation undercut A02, A03 with widths "70" - "100" (p. 245)	
tempered 6 mm glass in the colour of graphite or transparent	+10%
change of colour of decorative mouldings to black:	
version B1	
version A01-A03	
sliding system (except version A01)	p. 238-243

*dimension tolerance +/- 2 mm

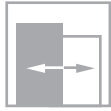
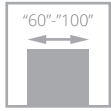

SONATA

NEW PATTERNS

NEW COLOURS



- **robust structure - wooden rail and stile set**
- stable in-fill **made of perforated board**
- **colours** from LAMISTONE CPL, SILKSTONE and UNIT MAT PLUS surfaces
- adjustable type K, type C and adjustable Duo hinge



SONATA door, W4 pattern, DIN SYSTEM adjustable door frame



aluminium decors on the door leaf surface in the colour of copper matt (pattern W09, W10, W11)



aluminium decors on the door leaf surface in the colour of black matt (pattern W09, W10, W11)



aluminium decors on the door leaf surface in the colour of black, golden gloss, chrome gloss (option) – p. 250



aluminium decors on the leaf surface in the colour of matt chrome (standard)

INTERIOR DOORS PANELLED LAMINATED



SONATA door, W2 pattern, VERTIGO adjustable door frame



VERSION W1 / VD1 W2 / VD2 W4 / VD4 W5 / VD5 W6 / VD6
LAMISTONE,
SILKSTONE surface
UNI MAT PLUS

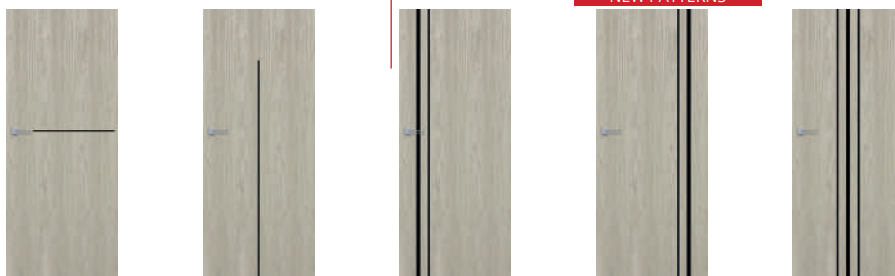

VERSION W7 / VD7 W8 / VD8 W9 / VD9 W10 / VD10 W11 / VD11
LAMISTONE,
SILKSTONE
UNI MAT PLUS

COLOURS



DOOR FRAMES

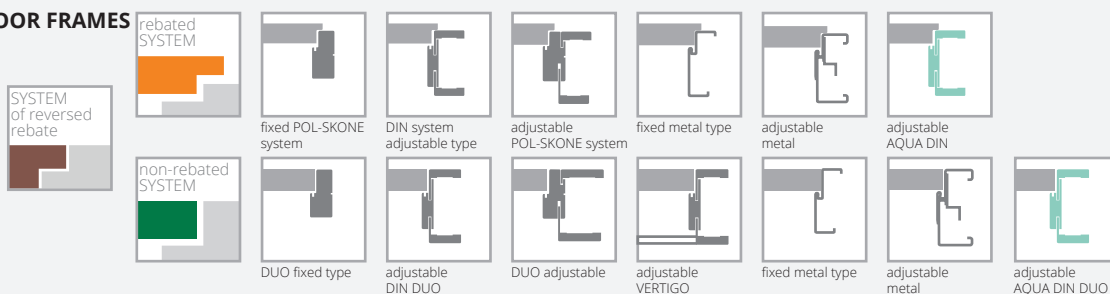

EQUIPMENT

STANDARD		
single-point lock, spacing: 72 mm (rebated sys.) or magnetic mortise lock (non-rebated system) for key (spacing: 90 mm), for cylinder (spacing: 85 mm) or for bathroom privacy lock (spacing: 90 mm)		third hinge in the door leaf: type C for a width of "60"-80" type K for width "60"-80" type M for width "60"-80" concealed DUO type for a width of "60"-70"
hinges: type K - for DIN system door frame, type C - for wooden door frame, type M - for metal door frame ("60"-80" - 2 pcs., "90" - 3 pcs.) or hidden DUO nickel satin ("60"-70" - 2 pcs., "90" - 3 pcs)		rail and stile set (for do-it-yourself shortening to 50 mm) (except versions W8, W09, W10, W11) rail and stile set (for do-it-yourself shortening to 90 mm) (except versions W8, W09, W10, W11) reinforcement for a door closer
for a door leaf with a door closer and DIN or metal door frame, use type T hinges in the quantity of "60"-80" - 3 pieces, "90"-100" - 4 pcs. (replacement of standard hinges for type T hinge for an extra charge)		bottom rail and stile set protector against excessive moisture (except door leaves with ventilation undercut)
patterns W09, W10, W11, aluminium decors, 25 mm and 10 mm wide, in the colour of chrome matt, black matt, copper matt		door lower by 50 mm or 100 mm (rebated sys.) without an extra charge
patterns W1-W8, 25 mm and 10 mm thick aluminium decors in the colour of black, chrome gloss, golden gloss		door lower by 55 mm or 100 mm (non-rebated sys.) without an extra charge
patterns W8, W09, W10, W11 unavailable with ventilation slot or ventilation grill		door higher by 50 mm or 100 mm (third hinge required for an extra charge) +10%
ADDITIONAL (available at an extra charge)		door higher by 150 mm or 200 mm (third hinge required for an extra charge) +20%
size "100"	+20%	ventilation undercut (p. 245)
REVES system (reversed rebate)		aluminium edge (non-rebated system)
recuperation trim	without an extra charge	door leaf edge in the colour of black, grey and graphite (except the REVES system) without an extra charge
solid chipboard in-fill (third hinge recommended)		

INTER-AMBER

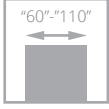

INTER-AMBER door, F00 pattern, DIN SYSTEM adjustable door frame

- **robust structure - wooden rail and stile set**
- **rich colours** from the ECO TOP and HIGH TOP surfaces
- AS4, 03SD patterns - white or brown matt 4 mm pattern AS4, 03SD - white or brown matt 4 mm **thick safe tempered glass pane**



muntin bar AS4



INTER-AMBER door, F06 pattern (door on the left), A00 pattern (door on the right), DIN SYSTEM adjustable door frame



VERSION **A00 / V00** **A01 / V2S** **AS4 / V2SD** **03SD / V3SD** **C00 / V03** **C01 / V3S1** **C02 / V3S2** **C03 / V3S3**

ECO TOP

HIGH TOP



VERSION **F00 / V06** **F01 / V6S1** **F02 / V6S2** **F06 / V6S6** **04SD / V4SD** **05SD / V5SD**

ECO TOP

HIGH TOP

COLOURS

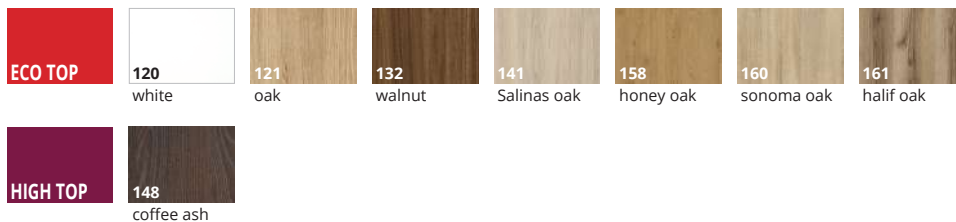

DOOR FRAMES

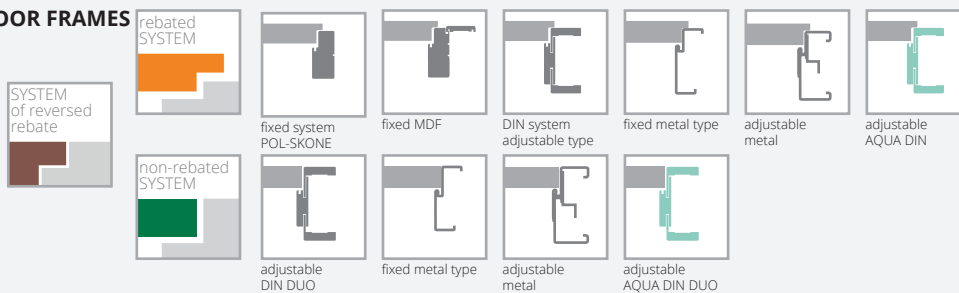

EQUIPMENT

STANDARD	
white/brown matt or translucent 4 mm thick glass pattern AS4, 03SD	
standard - 4 mm thick white / brown matt tempered glass pane	
single-point lock, spacing: 72 mm (rebated sys.) or magnetic mortise lock (non-rebated system) for key (spacing: 90 mm), for cylinder (spacing: 85 mm) or for bathroom privacy lock (spacing: 90 mm)	
hinges: type B – for DIN system door frame, type D - for wooden or MDF door frame, type M – for metal door frame or hidden DUO nickel satin ("60"-80" – 2 pcs, "90" – 3 pcs)	
for a door leaf with a door closer and DIN or metal door frame, use type T hinges in the quantity of "60"-80" - 3 pieces, "90"-110" - 4 pcs. (replacement of standard hinges for type T hinge for extra charge)	
ADDITIONAL (available at an extra charge)	
size "100" (glazing decoration as in "90")	
size "110" (glazing decoration as in "90")	
REVES system (reversed rebate) (version A00, C00, F00)	
recuperation trim	without an extra charge
perforated chipboard in-fill	
solid chipboard in-fill (third hinge recommended)	

third hinge in the door leaf or adjustable pivot hinge (1 piece price): type B, type D, type M for a width of "60"-80"	
type C	
type K	
concealed DUO type for a width of "60"-80"	
rail and stile set (for do-it-yourself shortening to 50 mm)	
rail and stile set (for do-it-yourself shortening to 90 mm)	
reinforcement for a door closer	
bottom rail and stile set protector against excessive moisture impact (except door leaves with ventilation undercut)	
door lower by 50 mm or 100 mm (rebated sys.)	without an extra charge
door lower by 55 mm or 100 mm (non-rebated sys.)	without an extra charge
door higher by 50 mm or 100 mm (third hinge required for an extra charge) (except the fixed MDF door frame)	+10%
door higher by 150 mm or 200 mm (third hinge required for an extra charge) (except the fixed MDF door frame)	+20%
ventilation undercut (p. 245)	
tempered glass (only applicable to 1 glass pane): version C, F	
version 04SD, 05SD	
transparent 4 mm thick tempered glass	+10%

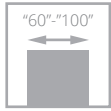

LUMEN



The door is built of a tempered glass pane suspended on the adjustable LUMEN door frame available with a full range of colours: ECO TOP, LAMISTONE CPL, SILKSTONE, laminated and veneered.



handle



hinge

LUMEN door, I pattern, LUMEN adjustable door frame



LUMEN door, I pattern, LUMEN adjustable door frame



NEW VENTILATION UNDERCUT

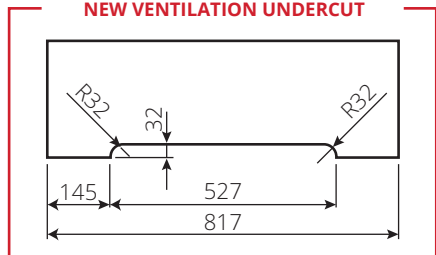

VERSION I

width "60" – "80" width "90" width "100"

glass pane: transparent, white satin

glass pane: brown satin, graphite satin

LUMEN (ZL) ADJUSTABLE FRAME



WIDTH

single-leaf door						
type	S _o	S _d	S _s	S _{opA}	S _{opB}	
"60"	676	646	617	748	788	
"70"	776	746	717	848	888	
"80"	876	846	817	948	988	
"90"	976	946	917	1048	1088	
"100"	1076	1046	1017	1148	1188	

HEIGHT

	H _o	H _d	H _s	H _{opA}	H _{opB}
	2053	2043	2016	2093	2113

S_o - installation opening width
 S_d - door width on the external side of the door frame
 S_s - door leaf width
 S_{opA} - door frame width along architraves "60"
 S_{opB} - door frame width along architraves "80"

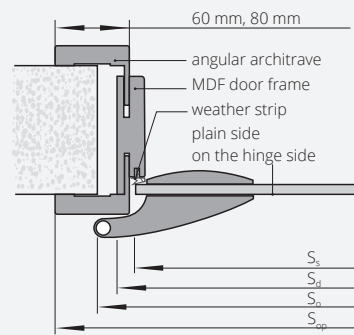

H_o - installation opening height
 H_d - door height on the external side of the door frame
 H_s - door leaf height
 H_{opA} - door frame height along architraves "60"
 H_{opB} - door frame height along architraves "80"

LUMEN	degree of adjustment (mm)	ECO TOP	for the laminated type			VENEERED						
			HIGH TOP	LAMISTONE CPL	SILKSTONE	UNI MAT PLUS	PAINTED* white	PAINTED* grey, beige	BLACK black, sage	GROUP A	GROUP B	GROUP C, D
ZL 1A	75-85											
ZL 1B	85-95											
ZL 2	95-120											
ZL 3	120-140											
ZL 4	140-160											
ZL 5	160-180											
ZL 6	180-200											
ZL 7	200-220											
ZL 8	220-240											
ZL 9	240-260											
ZL 10	260-280											
ZL 11	280-300											

*LUMEN door frame in the colours of PAINTED, available only with 80 mm wide architraves, in other colours with 60 mm and 80 mm wide architraves

EQUIPMENT

STANDARD	
tempered white / brown / graphite satin or transparent 8 mm thick glass	
ornament on the side opposite to the hinges	
height of handle for the glass pane standard height – 1038 mm from the glass pane bottom edge	
ADDITIONAL (available at an extra charge)	
fixed and adjustable metal door frame	p. 230-231
ventilation undercut (p. 245)	
glass pane with a non-standard height of 1966 mm	without an extra charge
electric NC door strike JIS 1710 12-24 V AC/DC (including latch plate and milling for the electric door strike)	
electric NC door strike BIRA HARTTE XS12U 12V AC/DC (including latch plate and milling for the electric door strike)	
electric NC door strike with the BIRA HARTTE XS12UW 12V AC/DC off-switch (including latch plate and milling for the electric door strike)	
electric NO door strike BIRA HARTTE XS12R 12V DC (including latch plate and milling for the electric door strike)	
DORMA hardware	acc. to table
architraves connected at the 90° angle (version C 90°)	

DORMA HARDWARE	aluminium EV1-Deco 114	aluminium stainless steel 107	black**
handle + small lock + hinges			
handle + WB + hinges			
handle + WC + hinges			
knob-handle + small lock + hinges*			

*ref. to the door plus electric strike set
 ** lower hinge with black cover, upper hinge: black, painted
 WB - for cylinder
 WC - for bathroom privacy lock

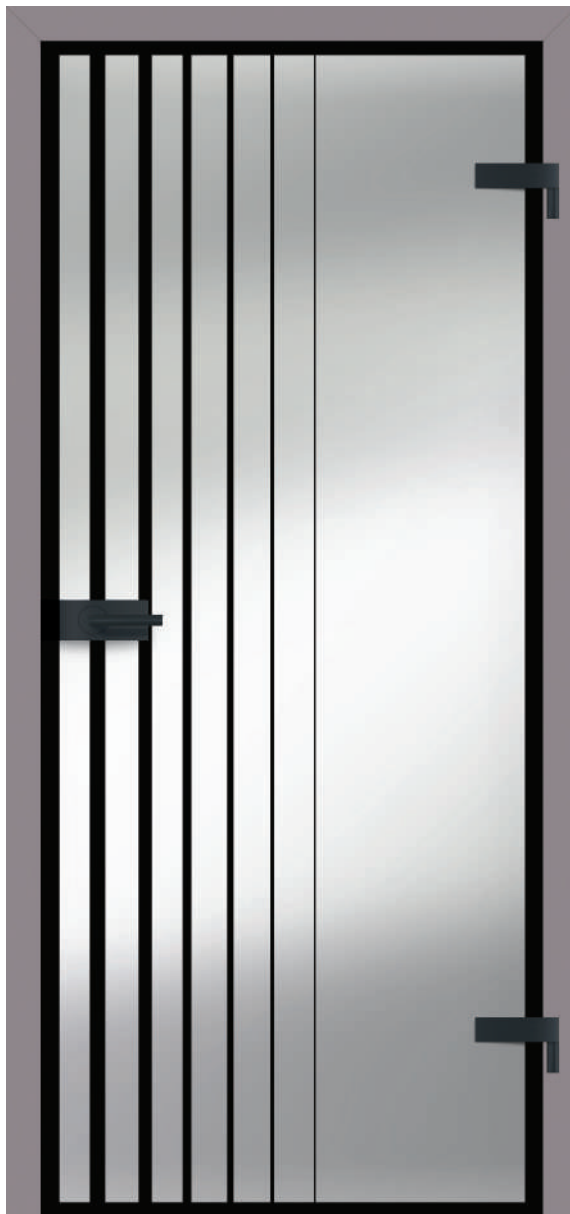
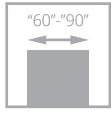

LUMEN LOFT

- 8 mm thick **tempered glass**
- **black or white** decor

The door is built of a tempered glass pane suspended on the LUMEN adjustable door frame available in all colours of: ECO TOP, LAMISTONE CPL, SILKSTONE, laminated and veneered.



handle



hinge

LUMEN LOFT door, V4 pattern, LUMEN adjustable door frame



LUMEN LOFT door, V2 pattern, LUMEN adjustable door frame



VERSION	V1	V2	V3	V4
		"60" - "80"		"90"

transparent glass,
white or black decor

white satin glass,
white or black decor

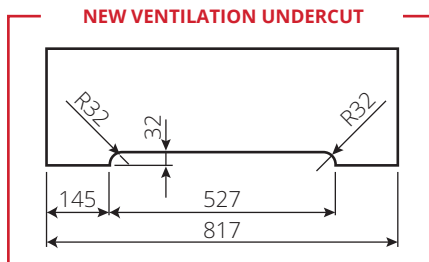

DOOR FRAMES

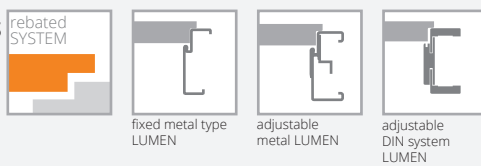

LUMEN adjustable door frame detailed dimensions and prices - p. 129

EQUIPMENT

STANDARD
tempered glass pane, thickness: 8 mm, transparent with one-sided black or white decor made by the method of screen printing
height of handle for the glass pane standard height - 1038 mm from the glass pane bottom edge
ADDITIONAL (available at an extra charge)
fixed and adjustable metal door frame p. 230-231
ventilation undercut
JIS 1710 12-24 V AC/DC NC electric door strike (including striker plate and milling for the electric strike)
BIRA HARTTE XS12U 12V AC/DC NC electric door strike (including striker plate and milling for the electric strike)
NC electric door strike with the BIRA HARTTE off-switch XS12UW 12V AC/DC (including striker plate and milling for the electric strike)
BIRA HARTTE XS12R 12V DC NO electric door strike (including striker plate and milling for the electric strike)
DORMA hardware

HARDWARE DORMA			
	aluminium EV1-Deco 114	aluminium stainless steel 107	black**
handle + small lock + hinges			
handle + WB + hinges			
handle + WC + hinges			
handle-knob + small lock + hinges*			

* door set including electric strike set
** lower hinge with black cover, upper hinge: black, painted

non-rebated
SYSTEM

"60"- "90"

"120"- "180"



FOLDING



Door leaf built of a **wooden rail and stile set** topped with two plain laminated or veneered HDF boards. The standard in-fill is a honeycomb-structured layer.



FOLDING door, 00 pattern, DIN SYSTEM DUO adjustable door frame

pull handle



FOLDING door, 00 pattern, DIN DUO adjustable door frame

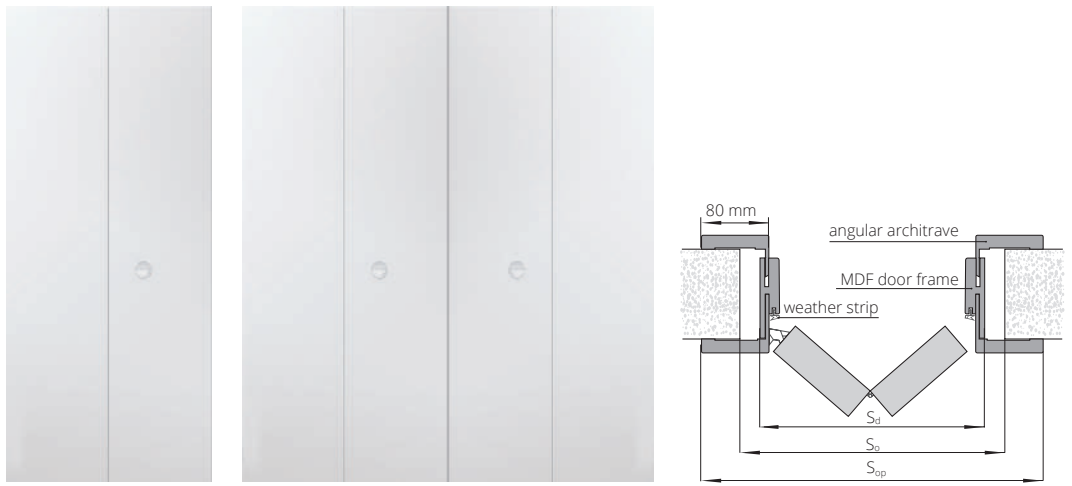

VERSION **00 / V00** **00 / V00 double-leaf door**

- PAINTED white
- PAINTED grey, beige
- ECO TOP
- UNI MAT PLUS
- HIGH TOP
- LAMISTONE CPL
- LAMINATED CPL
- SILKSTONE
- SILKSTONE CPL 0.5 mm
- VENEERED GROUP A
- VENEERED GROUP B
- VENEERED GROUP C, D

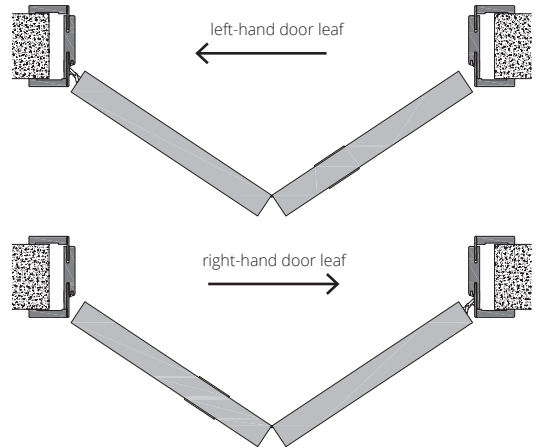

COLOURS



*except the fixed DUO door frame
*except the adjustable DUO door frame

DOOR FRAMES

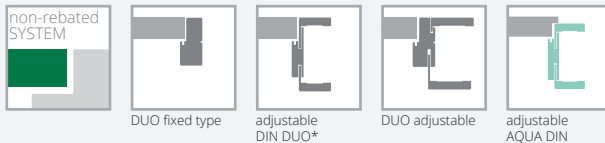

Folding door, DIN DUO door frame								Folding door, DIN DUO wooden fixed door frame						Folding door, DUO wooden adjustable door frame								
single-leaf door				double-leaf door				single-leaf door			double-leaf door			single-leaf door				double-leaf door				
type	S _o	S _d	S _{op}	type	S _o	S _d	S _{op}	type	S _o	S _d	type	S _o	S _d	type	S _o	S _d	S _{op}	type	S _o	S _d	S _{op}	
"60"	690	652	792	"60"+"60"	1305	1267	1407	"60"	713	693	"60"+"60"	1328	1308	"60"	713	693	836	"60"+"60"	1328	1308	1451	
"70"	790	752	892	"70"+"70"	1505	1467	1607	"70"	813	793	"70"+"70"	1528	1508	"70"	813	793	936	"70"+"70"	1528	1508	1651	
"80"	890	852	992	"80"+"80"	1705	1667	1807	"80"	913	893	"80"+"80"	1728	1708	"80"	913	893	1036	"80"+"80"	1728	1708	1851	
"90"	990	952	1092	"90"+"90"	1905	1867	2007	"90"	1013	993	"90"+"90"	1928	1908	"90"	1013	993	1136	"90"+"90"	1928	1908	2051	
HEIGHT				H _o	H _d	H _s	H _{op}	HEIGHT				H _o	H _d	H _s	HEIGHT				H _o	H _d	H _s	H _{op}
				2085	2079	2040	2133					2093	2083	2040					2093	2083	2040	2154

S_d, H_d - door dimensions on the external side of the door frame
S_o, H_o - recommended installation dimension
S_{op}, H_{op} - dimensions on the external side of the architrave
H_s - door leaf height

EQUIPMENT

STANDARD		
guide rail and concealed adjustable hinges in the door leaf	door lower by 55 mm	without an extra charge
hinges: hidden adjustable nickel satin "60" - "80" - 2 pcs; "90" - 3 pcs	door higher by 50 mm, 100 mm	+10%
round plastic pull handle	door higher by 150 mm, 200 mm	+20%
ADDITIONAL (available at an extra charge)		
perforated chipboard in-fill	third hinge hidden in the door leaf: hidden DUO for widths "60"- "80"	
solid chipboard in-fill (third hinge recommended)	single-point mortise lock, hook WB (only single-leaf doors)	
	pull handles for folding door leaves	p. 250

interior entrance doors

**burglar-proof, acoustic
(up to 42 dB), special doors**

**special fire doors with
30 min and 60 min
fire resistance**

**expanded range of auxiliary
accessories**

ENTRANCE AND TECHNICAL DOORS

Entrance and technical doors with high fire resistance and soundproofing guarantee the safety and comfort of people inside the building.

Fire doors as high as 2.5 metres are available on request. In addition, a wide range of joinery finishes, including more than 80 colours, provides great freedom of choice.

In addition, a wide range of joinery finishes, including more than 80 colours, provides great flexibility in matching the doors to individual functional and aesthetic requirements.



2
7



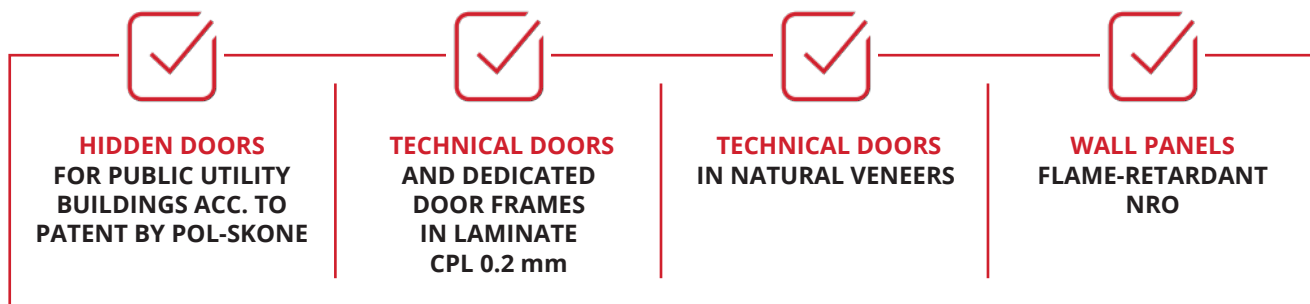

- Wood as the main structural material for our products (wood produced in our own sawmills)
- Declared product performance confirmed by tests in accredited laboratories
- Wide range of door leaves and door frames (painted, laminated, veneered)
- Coherent colour schemes for interior doors, technical doors, wall panels, skirting boards, and shaft doors.
- Range of two-coloured doors
- Availability of personalised doors with decorative ornaments, aluminium decors, stainless steel panels, pictograms
- Protectors of door leaf edges with ABS edging or stainless steel profiles
- In-house production of metal frames, choice of colour schemes, texture, availability of two-coloured adjustable door frames
- Steel or wooden thresholds, colour-matched with other door elements
- Door frames adjustable to wall thickness and panelling systems / portals for public utility building doors
- Width for public utility buildings at a standard price
- Glazed fire doors and EI30 fire toplights/sidelights, escape doors
- Door acoustic performance of up to 42 dB
- Wide range of hidden aluminium door frames - HARMONY; HARMONY INVEST; HARMONY INVEST PRO

SPECIFICATION OF ACOUSTIC PARAMETERS OF POL-SKONE DOORS

Door name	Rw test result	Class Rw	RA1 [dB]	RA2 [dB]	Class D1	Class D2
HARMONY INVEST	38 (-1;-2)	37	37	36	35	30
FR EI30 SR42, FR EI30 SR42 DM	43 (-1;-4)	42	42	39	40	35
RC3 wooden door frame, drop seal	33 (-1;-1)	32	32	32	30	30
RC4, RC4 EI30	37 (0; -1)	37	37	36	35	30
B-30, C-30, SR37	38 (0; -1)	37	38	37	35	35
RC3 wooden door frame, steel threshold	35 (-1; -1)	32	34	34	30	30
RC3, RC3 INVEST	33 (-1; -1)	32	32	32	30	30
Cerber Plus, Cerber Plus RC2 perforated chipboard, wooden door frame, drop seal	30 (0;0)	27	30	30	25	25
Cerber Plus, Cerber Plus RC2 solid chipboard, wooden door frame, drop seal	31 (0;-1)	27	31	30	25	25
Cerber Plus, Cerber Plus RC2 solid chipboard, metal door frame, drop seal	31 (-1; -1)	27	30	30	25	25
Cerber Plus, Cerber Plus RC2 chipboard, POL-SKONE in-fill, wooden door frame, drop seal	37 (-2; -3)	37	35	34	30	30
Cerber Plus, Cerber Plus RC2 chipboard, POL-SKONE in-fill, wooden door frame, threshold	40 (-1; -4)	37	39	36	35	30
Cerber Plus, Cerber Plus RC2 chipboard, POL-SKONE in-fill, metal door frame, drop seal	37 (-1; -3)	37	36	34	30	30
RC3 INVEST 37 dB	37 (-1; -2)	37	36	35	30	30
AKUSTIK 42 dB	42 (-1;-4)	42	41	38	35	35

Things worth remembering when placing orders for public utility projects, i.e. hospitals, schools, administration offices, medical care units etc.

1. DOOR LEAF TYPE

It is recommended to offer plain door leaves with panelled structure, i.e. DECO, DECO INVEST, IMPULS, HAPTIC, INTER-AMBER, CAMBIO etc.

2. APPROPRIATE SELECTION OF THE DOOR MECHANICAL CLASS

Minimum **mechanical class 2** acc. to PN-EN 1192:2001. It is recommended to offer interior doors in mechanical class 3. Special reinforced design: type C, type K or three-part type T hinges, LOB lock with stainless steel face plate.

3. COMPLYING WITH THE REQUIREMENTS FOR THE CLEARANCE

For doors with the 90-degree opening angle, the "90 Plus" with should be offered.

The "90 plus" door width provides a min. clearance of 900 mm for doors with the 90-degree opening angle.

4. SUITABLE HINGES

We recommend offering the following types of hinges:

- type T for steel and DIN door frame,
- type C for wooden door frame and type K for DIN door frame.

5. SUITABLE DOOR FRAME

We recommend offering primarily steel door frames, DIN door frames, wooden door frames (fixed and adjustable).

We do not offer the fixed MDF door frame for public utility buildings.

6. DOOR LEAF IN-FILLS

We recommend offering the perforated chipboard in-fill. The solid board is optional.

7. SUITABLE COATING OF DOOR LEAVES AND FRAMES.

We recommend offering at least the LAMISTONE surface finish. Recommended coatings: CPL, HPL. As means of additional protection, we recommend suggesting stainless steel panels at handle height and at the bottom of the door leaf. Stainless steel edge guards.

8. We recommend offering HIGRO door FOR INTERIORS with increased humidity.

The door is designed for interiors in which the permissible relative air humidity is up to 90% and temperature does not exceed 65°C. The door must not be directly exposed to water.

9. FOR HOSPITALS, SCHOOLS

We recommend offering the DECO INVEST door leaves with a metal door frame and stainless steel panels and covers.

The 0.8 mm thick ABS edging is available.

10. DOOR CLOSER

Choose the right type of the door closer for your door type. Reinforcement for the door closer should be used in the door.

ACOUSTIC COMPARISON OF POL-SKONE DOORS ACC. TO THE PN-B-02151-3:201 STANDARD

Type of building	Exemplary applications	Requirements	Exemplary door names
multi-family buildings	doors for flats	$R_{a1R} \geq 30$ dB	B-30, C-30, RC3, SR37, Cerber Plus SR37, Cerber Plus RC2 SR37, RC4, RC4 EI30, RC3 INVEST, RC3 INVEST 37 dB
higher category hotels	doors between the hotel room and the general communication area (corridors, halls, staircases)	$R_{a1R} \geq 35$ dB	EI30 of the Pol-Skone system SR42, Type B DUO, Harmony Invest
lower category hotels	tourist standard hotels, boarding houses, holiday houses	$R_{a1R} \geq 30$ dB	EI30 Pol-Skone system, EI30 Pol-Skone system SR42, EI30 Plus, EI60 Plus, Typ B, Typ B DUO, Harmony Invest
collective dwelling facilities	student dormitories, boarding schools, workers' hostels, children's homes, social welfare homes	$R_{a1R} \geq 30$ dB	B-30, C-30, RC3, SR37, Cerber Plus SR37, Cerber Plus RC2 SR37, RC4, RC4 EI30, RC3 INVEST, Harmony Invest
hospitals	doctors' consulting rooms	$R_{a1R} \geq 35$ dB	EI30 of the Pol-Skone system SR42, Type B DUO, Harmony Invest
	doctors and nurses rooms	$R_{a1R} \geq 30$ dB	EI30 Pol-Skone system, EI30 Pol-Skone system SR42, EI30 Plus, EI60 Plus, Typ B, Typ B DUO, Harmony Invest

SPECIFICATION OF POL-SKONE BURGLAR-PROOF DOOR

Type of building	Burglary resistance	Door name
multi-family buildings – doors for flats	class RC4 (acc. to PN-EN 1627:2012)	RC4, RC4 EI30
	class RC2 (acc. to PN-EN 1627:2012)	Cerber Plus RC2
	class RC3 (acc. to PN-EN 1627:2012)	B-30, C-30, RC3, RC3 INVEST, RC3 INVEST 37 dB
	Class C (acc. to PN-B-92270:1990)	C-30, RC4, RC4 EI30

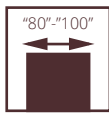

90 PLUS
WIDTH
FOR PUBLIC
UTILITY
BUILDINGS



B-30 door, W00 pattern, one-sidedly adjustable door frame

BURGLAR-PROOF DOOR POL-SKONE

B-30/C-30

NOTE! In order to meet the fire resistance conditions, a door closer compliant with the requirements of the PN-EN 1154:1999/A1:2004/AC:2010 standard, door handles compliant with the requirements of the PN-EN 1906:2012 (min. class B with regard to fire resistance and min. class 3 with regard to burglary resistance), lock cylinders compliant with the requirements of the PN-EN 1303:2015 standard (min. class 4 key-related resistance, min. class 1 attack resistance and class B fire resistance).

Interior entrance door leading from corridors or staircases to e.g. flats in multi-family buildings or rooms in public utility buildings.

Door leaf built of a wooden rail and stile set topped with two HDF boards. The in-fill is a special POL-SKONE structure. The leaf thickness is 56 mm.

Burglary resistance

POL-SKONE B-30 – class RC3 acc. to PN-EN 1627:2012

POL-SKONE C-30 – class RC3 acc. to PN-EN 1627:2012

– class C acc. to PN-B-92270:1990

Smoke control – class Sa, S₂₀₀

Fire resistance – class EI₂30

Acoustic insulation capacity – D1-35, D2-35, R_w=37 dB

mechanical strength class 4 acc. to PN-EN 1192:2001

National Technical Assessment ITB– KOT-2018/0713
issue 1

National certificate of Constancy of Performance no
020-UWB-2728/W



B-30 door, W00 pattern, fixed wooden door frame



B-30



C-30



**ADJUSTABLE DOOR FRAME
FOR ENTRANCE DOORS**
- p. 174

VERSION	W00	VERSION	W00
LAMISTONE CPL		LAMISTONE CPL	
UNI MAT PLUS		UNI MAT PLUS	
SILKSTONE		SILKSTONE	
SILKSTONE CPL 0.5 mm		SILKSTONE CPL 0.5 mm	
LAMINATED CPL 0.2 mm		LAMINATED CPL 0.2 mm	
PAINTED (RAL 9003)*		PAINTED (RAL 9003)*	
PAINTED - beige, grey		PAINTED - beige, grey	
PAINTED - black, sage		PAINTED - black, sage	
VENEERED GROUP A		VENEERED GROUP A	
VENEERED GROUP B		VENEERED GROUP B	
VENEERED GROUP C, D		VENEERED GROUP C, D	
SILKWOOD		SILKWOOD	

*standard colour for wooden leaves and frames - white RAL 9003.

extra charge added to the basic colour white (RAL 9003) acc. to RAL, NCS colour groups (p. 264)

Group I	Group II	Group III	Group IV	Group V
CPL 0.5 mm ("60" - "90")	CPL 0.7 mm ("60" - "90")	CPL 0.5 mm ("90+" - "110")	CPL 0.7 mm ("90+" - "110")	

extra charge CPL 0.5 mm, CPL 0.7 mm to door in CPL laminate coating (extra charge to standard door height)



oak threshold



multi-point lock



upper rose



hinge



security bolts



multi-point lock

DOOR DIMENSIONS

Fixed or adjustable wooden door frame:

standard: 1012x2075 mm
optional: 980x2075 mm, 880x2075 mm, 1012x2000 mm, 980x2000 mm, 880x2000 mm, 1012x1950 mm, 980x1950 mm, 880x1950 mm
max. width 1112 mm, max. height 2175 mm

ATTENTION! The C-30 door wider than 1012 mm or higher than 2075 mm are not smoke-proof.

WIDTH FOR PUBLIC UTILITY BUILDINGS

90 Plus width - 1032x2075 mm.

The 1032 mm door width provides a min. clearance of 900 mm for door leaves with the 90° opening angle.

DOOR LEAF FINISH

Plain surface painted, veneered, covered with CPL laminate with a thickness of 0.2 to 0.7 mm, HPL laminate with a thickness of 0.7 to 1.0 mm or wood-alike foil.

Flat decors, made of decorative profiled mouldings, aluminium decors available (subject to the consultation with the Sales Department).

DOOR FRAMES

Door frame painted, veneered, covered with CPL 0.15 mm, CPL 0.2 mm laminate or foil matched to the colour of the door leaf.

Fixed wooden pine door frame – optionally with masking strips, quarter round.

Wooden adjustable door frame with widening panels, angle architraves and a masking strip. Optional: 210 mm wide and 16 mm thick side architrave (vertical elements).
- p. 257.

ACCESSORIES AND EQUIPMENT

Standard equipment of the B-30 door:

- pivot hinges adjustable in 3 planes by OTLAV
- four-point bolt lock by LOB (2 bolts, 2 hooks) for cylinder with a spacing of 72 mm
- burglar-proof bolts - 5 pcs
- oak threshold in the colour of natural oak, black, grey, brown with an aluminium strip to provide protection against excessive wear

Standard equipment of the C-30 door:

- pivot hinges adjustable in 3 planes by OTLAV
- five-point bolt lock by LOB (2 bolts, 3 hooks) for cylinder with a spacing of 72 mm
- complete set of class 6 cylinders
- handle and upper rose by GARDA with cylinder protector - colour of inox
- burglar-proof bolts - 5 pcs
- oak threshold in the colour of natural oak, black, grey, brown with an aluminium strip to provide protection against excessive wear

Additional equipment for B-30:

- aluminium decors, decorative elements, surface or hidden door closer, electromagnetic lock by DORMAKABA, reed switch
- GARDA handle in the colour of inox
- GARDA rose in the colour of inox
- a set of class 6 cylinders in the colour of nickel-matt
- GARDA handle in the colour of black

- GARDA upper rose in the colour of black
- a set of class 6 cylinders in the colour of black
- width of 1112 mm **+10%**
- height of 2175 mm **+10%**
- panoramic viewer - stainless steel; brass, anthracite, black matt

Additional equipment for C-30:

- decorative elements, top or hidden door closer, electromagnetic lock by DORMAKABA, reed switch
- aluminium decors, new patterns - p. 201
- GARDA handle colour change to black
- GARDA upper rose colour change to black
- class 6 cylinder colour change to black
- width of 1112 mm **+10%**
- height of 2175 mm **+10%**
- standard oak threshold colour change to the colour of black, grey, brown - **without an extra charge** (p. 207)
- edging colour change to the colour of grey, graphite, black
- panoramic viewer - stainless steel; brass, anthracite, black matt

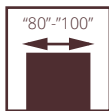

90 PLUS
WIDTH
FOR PUBLIC
UTILITY
BUILDINGS



BURGLAR-PROOF DOOR POL-SKONE

RC4

Interior entrance doors are designed as closures for interior passages between a staircase or a corridor and rooms. Inward-opening and outward-opening. Special POL-SKONE structure based on a solid **wooden rail and stile set** reinforced with plywood. The in-fill is a set of chipboards reinforced with steel rods. Leaf thickness: 50 mm. Fixed metal door frame made of 1.5 mm thick DC01 metal sheet, stainless steel 1.5 mm thick threshold.

Burglary resistance: **class RC4** acc. to PN-EN 1627:2012 and **class C** acc. to PN-B-92270:1990
Acoustic insulation capacity: **Rw= 37 dB, D₁-35, D₂-30**
Mechanical strength: **class 4** acc. to PN-EN 1192:2001
Mechanical durability: **class 5** acc. to PN-EN 12400:2004
National Technical Assessment: **ITB- KOT-2019/0804 issue 2**

RC4 door, 00 pattern, fixed metal door frame



RC4 door, 00 pattern, fixed metal door frame



RC4



VERSION flush leaf 00

- UNI MAT PLUS
- LAMINATED CPL 0.2 mm
- LAMISTONE CPL
- SILKSTONE
- SILKSTONE CPL 0.5 mm
- PAINTED – white
- PAINTED – grey, beige
- PAINTED - black, sage
- VENEERED GROUP A
- VENEERED GROUP B
- VENEERED GROUP C, D
- SILKWOOD

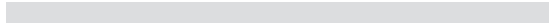

Metal RC4 fixed door frame, DC01 metal sheet, thickness: 1.5 mm

Stainless steel threshold, thickness: 1.5 mm

The door leaf price includes **cylinders and handle**. The technical parameters refer to a set including a door leaf, a metal door frame and a stainless steel threshold. **In order to comply with the national technical assessment, it is required to purchase a complete door set, i.e. door leaf, metal door frame and stainless steel threshold.**



stainless steel threshold



multi-point lock



multi-point lock



hinge

DOOR DIMENSIONS

Door with the metal door frame:
 904x2066 mm, 1004x2066 mm, 1104x2066 mm
 Doors with non-standard heights are available. Maximum dimension 1104x2166 mm

WIDTH FOR PUBLIC UTILITY BUILDINGS
The 90 Plus version (it allows getting a min. clearance of 900 mm for the door leaf with a 90° opening angle)
1024x2071 mm

DOOR LEAF FINISH

Plain surface painted, veneered, covered with CPL laminate with a thickness of 0.2 to 0.7 mm, HPL laminate with a thickness of 0.7 to 1.0 mm or wood-alike foil. Decorations made of decorative profiled mouldings available.

DOOR FRAMES

Fixed metal door frame made of 1.5 mm thick DC01 metal sheet powder-coated in white (RAL 9016 and RAL 9003), grey (RAL 7047), brown (RAL 8014), beige (RAL 1001), graphite (RAL 7024), black (RAL 9005).

ACCESSORIES AND EQUIPMENT

- Standard equipment of the set**
- five-point bolt lock
 - object 3D adjustable angular hinges – 2 pcs
 - security bolts - 5 pcs
 - a set of class 6 cylinders in the colour of nickel-matt
 - TORONTO handle and rose by Axa - silver colour
 - fixed metal door frame made of 1.5 mm thick DC01 metal sheet
 - stainless steel 1.5 mm thick threshold
 - incompatible with a hidden door closer

* extra charge to standard door height

Additional equipment

- extra charge for CPL 0.5 mm laminate*: width "80"- "90" - ; width "90+","100" width 1104 mm **+10%**, height 2166 mm **+10%**
- extra charge for CPL laminate 0.7 mm*: width "80"- "90"; width "90+","100"
- extra charge for a width of 1104 mm **+10%**
- extra charge for a height of 2166 mm **+10%**
- TORONTO handle colour change to black
- TORONTO upper rose colour change to black
- class 6 cylinder colour change to black - from surface-mounted door closer, reed switch - p. 203-207
- edging colour change to the colour of grey, graphite, black
- panoramic viewer - stainless steel; brass, anthracite, black matt

FIXED METAL DOOR FRAME

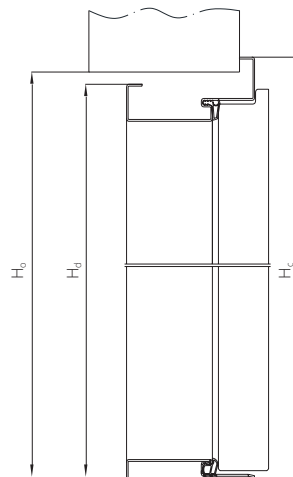
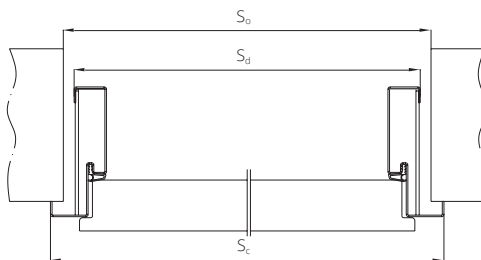

	width [mm]			height [mm]		
	Sc	Sd	So	Hc	Hd	Ho
"80"	904	860	880	1966	1944	1954
"90"	1004	960	980	2066	2044	2054
"90 Plus"	1024	980	1000	2166	2144	2154
"100"	1104	1060	1080			

Colours of metal door frames (p. 223)

*extra charge added to the basic colour white (RAL 9003) acc. to RAL, NCS colour groups (p. 264)

Group I	Group II	Group III	Group IV	Group V
---------	----------	-----------	----------	---------

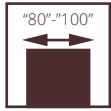

RC4 EI30 door, 00 pattern, fixed metal door frame

RC4 EI30

NOTE! To fulfil the fire resistance conditions, the door should be provided with a door closer compliant with the PN-EN 1154:1999/A1:2004/AC:2010 standard.

Interior entrance doors are designed as closures for interior passages between a staircase or a corridor and rooms. Inward-opening and outward-opening. Special POL-SKONE structure based on a solid **wooden rail and stile set** reinforced with plywood. The in-fill is a set of chipboards reinforced with steel rods. Leaf thickness: 50 mm. Fixed metal door frame made of 1.5 mm thick DC01 metal sheet, stainless steel 1.5 mm thick threshold.

Burglary resistance: **class RC4** acc. to PN-EN 1627:2012 and **class C** acc. to PN-B-92270:1990

Fire resistance – **class EI₃₀**

acoustic insulation capacity: **Rw= 37 dB, D₁₋₃₅, D₂₋₃₀**

Mechanical strength: **class 4** acc. to PN-EN 1192:2001

Mechanical durability: **class 5** acc. to PN-EN 16034: 2014

National Technical Assessment: **ITB- KOT-2019/0804 issue 2**

National Certificate of Constasy of Performance

no 020-UWB-2815/W



multi-point lock



hinge



RC4 EI30 door, 00 pattern, fixed metal door frame





FIXED METAL DOOR FRAME

	width [mm]		
	Sc	Sd	So
"80"	904	860	880
"90"	1004	960	980
"90 Plus"	1024	980	1000
"100"	1104	1060	1080

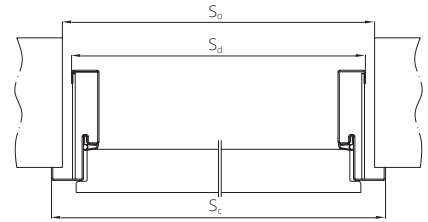

	height [mm]		
	Hc	Hd	Ho
	1966	1944	1954
	2066	2044	2054
	2166	2144	2154

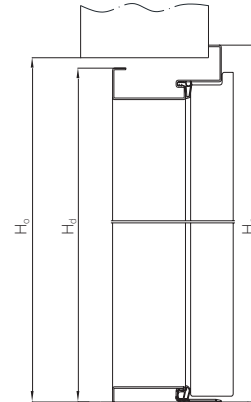

VERSION

flush leaf 00

UNI MAT PLUS
 LAMINATED CPL 0.2 mm
 LAMISTONE CPL
 SILKSTONE
 SILKSTONE CPL 0.5 mm
 PAINTED – white
 PAINTED – grey, beige
 PAINTED - black, sage
 VENEERED GROUP A
 VENEERED GROUP B
 VENEERED GROUP C, D
 SILKWOOD

Metal RC4 fixed door frame, DC01
 metal sheet, thickness: 1.5 mm
 Stainless steel 1.5 mm
 thick threshold

The door leaf price includes **cylinders and handle**. The technical parameters refer to a set including a door leaf, a metal door frame and a stainless steel threshold. **In order to comply with the national technical assessment, it is required to purchase a complete door set, i.e. door leaf, metal door frame and stainless steel threshold.**

extra charge added to the basic colour white (RAL 9003)
 acc. to RAL, NCS colour groups (p. 264)

Group I	Group II	Group III	Group IV	Group V



Toronto handle and rose in the colour of black



stainless steel threshold

extra charge CPL 0.5 mm, CPL 0.7 mm to door in CPL laminate coating (extra charge to standard door height)

CPL 0.5 mm ("60" - "90")	CPL 0.7 mm ("60" - "90")	CPL 0.5 mm ("90+" - "110")	CPL 0.7 mm ("90+" - "110")

DOOR DIMENSIONS

Door with the metal door frame:
 904x2066 mm, 1004x2066 mm, 1104x2066 mm
 max. width 1104 mm, max. height 2166 mm
 doors with non-standard heights are available

WIDTH FOR PUBLIC UTILITY BUILDINGS

90 Plus width - 1024x2066 mm.

The 1024 mm door width provides a min. clearance of 900 mm for doors with the 90-degree opening angle.

DOOR LEAF FINISH

Plain surface painted, veneered, covered with CPL laminate with a thickness of 0.2 to 0.7 mm, HPL laminate with a thickness of 0.7 to 1.0 mm or wood-alike foil.
 Flat decors made of decorative profiled mouldings available (subject to the consultation with the Sales Department).

DOOR FRAMES

Fixed metal door frame made of sheet steel of a thickness of 1.5 mm, standard powder-coated in the colour of white (RAL 9016 and RAL 9003), grey (RAL 7047), brown (RAL 8014), beige (RAL 1001), graphite (RAL 7024), black (RAL 9005).

Door frames painted in non-standard colours from RAL or NCS palettes are available upon consultation with the Sales Department.

ACCESSORIES AND EQUIPMENT

Standard equipment:

- five-point bolt lock
- object 3D adjustable angular hinges – 3 pcs
- security bolts - 5 pcs
- Toronto handle and rose by Axa - silver colour
- a set of class 6 cylinders in the colour of nickel-matt
- intumescent seals
- fixed metal door frame made of 1.5 mm thick DC01 metal sheet
- stainless steel 1.5 mm thick threshold
- incompatible with a hidden door closer

Additional equipment:

- width "100" **+10%**
- higher by 100 mm **+10%**
- extra charge for CPL 0.5 mm laminate*: width "80"- "90"; width "90+" - "100"
- extra charge for the CPL 0.7 mm laminate*: width "80"- "90"; width "90+" - "100"
- decorations, surface-mounted door closer, reed switch
- EMC 600 ALH electromagnetic lock
- panoramic viewer - stainless steel; brass, anthracite, black matt
- TORONTO handle colour change to black
- TORONTO upper rose colour change to black
- class 6 cylinder colour change to black
- leaf edging in the colour of black, grey or graphite
- arm, rail door closers - p. 205

* extra charge to standard door height

NOTE! To fulfil the fire resistance conditions, the door should be provided with a door closer compliant with the PN-EN 1154:1999/A1:2004/AC:2010 standard.

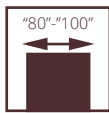

RC3 door, W0 pattern, fixed wooden door frame

BURGLAR-PROOF DOOR POL-SKONE

RC3

RC3 INVEST

NOTE! To ensure that the door meets burglary resistance specifications, door handles should comply with the PN-EN 1906:2012 standard (min. class 3 burglary resistance) and lock cylinders should comply with the requirements of the PN-EN 1303:2015 standard (min. class 4 key-related resistance and min. class 1 attack resistance).

Interior entrance door from corridors or staircases to, e.g., flats in multi-family buildings or rooms in public utility buildings.

Door leaf built of a wooden rail and stile set topped with two HDF boards. The in-fill is a special POL-SKONE structure. Leaf thickness: 50 mm.

RC3, RC3 INVEST

- Burglary resistance class RC3 acc. to PN-EN 1627:2012
- Acoustic insulation capacity – D1-30, D2-30, Rw=32 dB
- class 4 mechanical strength acc. to PN-EN 1192:2001
- National Technical Assessment ITB –KOT-2018/0713 issue 1



RC3



RC3 INVEST



RC3 door, W0 pattern, fixed wooden door frame



RC3 INVEST door, pattern W0, fixed metal door frame

RC3



RC3 door with a wooden door frame

VERSION

UNI MAT PLUS
LAMINATED CPL 0.2 mm
LAMISTONE CPL
SILKSTONE
SILKSTONE CPL 0.5 mm
PAINTED – white
PAINTED – grey, beige
PAINTED - black, sage
VENEERED GROUP A
VENEERED GROUP B
VENEERED GROUP C, D
SILKWOOD

RC3 INVEST



RC3 INVEST door with metal door frame

VERSION

UNI MAT PLUS
LAMINATED CPL 0.2 mm
LAMISTONE CPL
SILKSTONE
SILKSTONE CPL 0.5 mm
PAINTED - white
PAINTED – grey, beige
PAINTED - black, sage
VENEERED GROUP A
VENEERED GROUP B
VENEERED GROUP C, D
SILKWOOD

ADJUSTABLE DOOR FRAME FOR ENTRANCE DOOR
- p. 174

RC3 INVEST FIXED METAL DOOR FRAME

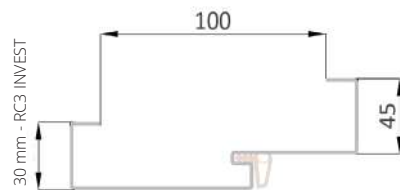

RC3 door with metal frame available with the BIRA ES 1 NC electric strike (symmetrical) - p. 205

CAUTION: NEW ARCHITRAVE WIDTH

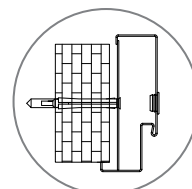

anchor installation hole in the centre of the profile on the frame's body

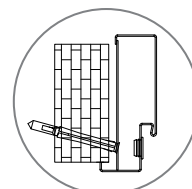

anchor installation hole in the frame rabbet

*extra charge added to the basic colour white (RAL 9003) for door with a wooden door frame and leaves acc. to RAL, NCS colour groups (p. 264)

Group I	Group II	Group III	Group IV	Group V
---------	----------	-----------	----------	---------

Extra charge to the colours of metal door frames (p. 223)



handle



hinge

DOOR DIMENSIONS

RC3

Fixed or adjustable wooden door frame:

1012x2075 mm, 980x2075 mm, 880x2075 mm,
1012x2000 mm, 980x2000 mm, 880x2000 mm,
1012x1950 mm, 980x1950 mm, 880x1950 mm.
"100" door max. width 1112 mm, max. height 2175 mm

RC3 INVEST

Fixed metal door frame:

924x2077 mm, 1024x2077 mm

WIDTH FOR PUBLIC UTILITY BUILDINGS

90 Plus width - 1032 mm.

The 1032 mm door width provides a min. clearance of 900 mm for doors with the 90-degree opening angle.

WIDTH FOR PUBLIC UTILITY BUILDINGS

90 Plus width - 1044 mm.

The 1044 mm door width provides a min. clearance of 900 mm for doors with the 90-degree opening angle.

DOOR LEAF FINISH

Plain surface painted, veneered, covered with CPL laminate with a thickness of 0.2 to 0.7 mm, HPL laminate with a thickness of 0.7 to 1.0 mm or wood-alike foil. Flat decors, made of decorative profiled mouldings, aluminium decors available (subject to the consultation with the Sales Department).

DOOR FRAMES

Door frame painted, veneered, covered with CPL 0.15 mm, CPL 0.2 mm laminate or foil matched to the colour of the door leaf.

Fixed wooden pine door frame - optionally with masking strips, quarter round.

Wooden adjustable door frame with widening panels, angle architraves and a masking strip.

Optional: 210 mm wide and 16 mm thick side architrave (vertical elements) - p. 257.

ACCESSORIES AND EQUIPMENT

Standard equipment of RC3:

- 4 pivot hinges adjustable in 3 planes by OTLAV
- four-point bolt lock by FUHR (2 bolts, 2 hooks) for cylinder with a spacing of 92 mm
- security bolts - 5 pcs
- oak threshold in the colour of natural oak, black, grey, brown with an aluminium strip to provide protection against excessive wear

Standard equipment of RC3 INVEST:

- RC3 INVEST metal door frame
- stainless steel threshold
- mortise four-point bolt lock (2 bolts, 2 hooks), spacing: 92 mm, colour: silver
- pivot hinges adjustable in 3 planes in the colour of silver - 4 pcs
- security bolts - 5 pcs
- GARDA rose in the colour of inox
- GARDA handle (spacing: 92 mm) in the colour of inox
- a set of class 6 cylinders in the colour of nickel-matt

Additional equipment:

- extra charge for CPL 0.5 mm laminate*: width "80":"90"; width "90+":,"100"
- extra charge for the CPL 0.7 mm laminate*: width "80":"90"; width "90+":,"100"
- width 1104 mm **+10%**, height 2166 mm **+10%**
- decorative elements, surface-mounted or hidden door closer, electromagnetic lock by DORMAKABA, reed switch - p. 203-207
- change of oak threshold to stainless steel threshold
- aluminium decors, new patterns - p. 201
- GARDA handle in the colour of inox
- GARDA rose in the colour of inox
- a set of class 6 cylinders in the colour of nickel-matt
- GARDA handle in the colour of black
- GARDA upper rose in the colour of black
- a set of class 6 cylinders in the colour of black
- "100" door width 1112 mm **+10%**
- height of 2175 mm **+10%**
- standard oak threshold colour change to the colour of black, grey, brown - **without an extra charge** (p. 207)
- edging colour change to the colour of grey, graphite, black
- panoramic viewer - stainless steel; brass, anthracite, black matt
- electric strikes - p. 205

* extra charge to standard door height

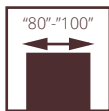

RC3 INVEST door, W0 pattern, fixed metal door frame

BURGLAR-PROOF DOOR POL-SKONE

RC3 INVEST 37 dB

NOTE! To ensure that the door meets burglary resistance specifications, door handles should comply with the PN-EN 1906:2012 standard (min. class 3 burglary resistance) and lock cylinders should comply with the requirements of the PN-EN 1303:2015 standard (min. class 4 key-related resistance and min. class 1 attack resistance).

Interior entrance door from corridors or staircases to, e.g., flats in multi-family buildings or rooms in public utility buildings.

Door leaf built of a wooden rail and stile set topped with two HDF boards. The in-fill is a special POL-SKONE structure. Leaf thickness: 57 mm.

RC3 INVEST SR 37 dB

- Burglary resistance class RC3 acc. to PN-EN 1627:2021
- Acoustic insulation capacity - D1-30, D2-30, Rw=37 dB
- class 4 mechanical strength acc. to PN-EN 1192:2001
- mechanical durability: class 5 acc. to PN-EN 12400:2004
- Manufactured in accordance with the PN-EN 14351-2:2018 standard



RC3 INVEST SR 37 dB door, W0 pattern, fixed metal door frame

RC3 INVEST SR37 dB



VERSION

RC3 INVEST 37 dB door
with metal door frame

UNI MAT PLUS
LAMINATED CPL 0.2 mm
LAMISTONE CPL
SILKSTONE
SILKSTONE CPL 0.5 mm
PAINTED – white
PAINTED – grey, beige
PAINTED - black, sage
VENEERED GROUP A
VENEERED GROUP B
VENEERED GROUP C, D
SILKWOOD

Extra charge to the colours of metal door frames (p. 223)

*extra charge added to the basic colour white (RAL 9003) for door with a metal door frame and leaves acc. to RAL, NCS colour groups (p. 264)

Group I	Group II	Group III	Group IV	Group V
---------	----------	-----------	----------	---------

RC3 INVEST SR 37 dB FIXED METAL DOOR FRAME

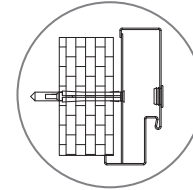
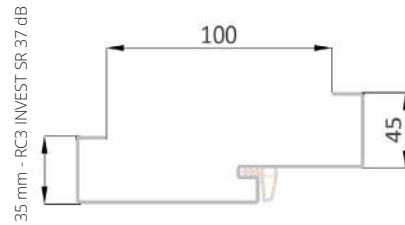

anchor installation hole
in the centre of the profile on
the frame's body



stainless steel threshold



RC3 INVEST 37dB hinge

DOOR DIMENSIONS

RC3 INVEST 37 dB
Fixed metal door frame:
920x2080 mm, 1020x2080 mm
"100" door max. width 1120 mm, max. height 2180 mm

WIDTH FOR PUBLIC UTILITY BUILDINGS
90 Plus width - 1040 mm.
The 1040 mm door width provides a min. clearance of 900 mm for doors with the 90-degree opening angle.

DOOR LEAF FINISH

Plain surface painted, veneered, covered with CPL laminate with a thickness of 0.2 to 0.7 mm, HPL laminate with a thickness of 0.7 to 1.0 mm or wood-alike foil.
Flat decors, made of decorative profiled mouldings, aluminium decors available (subject to the consultation with the Sales Department).

DOOR FRAMES

Fixed metal door frame made of sheet steel of a thickness of 1.5 mm, standard powder-coated in the colour of white (RAL 9016 and RAL 9003), grey (RAL 7047), brown (RAL 8014), beige (RAL 1001), graphite (RAL 7024), black (RAL 9005).

Door frames painted in non-standard colours from RAL or NCS palettes are available upon consultation with the Sales Department.

ACCESSORIES AND EQUIPMENT

Standard equipment of RC3 INVEST 37 dB:
- RC3 INVEST metal door frame
- stainless steel threshold with rabbit seal
- security bolts - 4 pcs
- object 3D adjustable angular hinges – 2 pcs
- mortise four-point bolt lock (2 bolts, 2 hooks), spacing: 92 mm, silver colour

Additional equipment:
- extra charge for CPL 0.5 mm laminate*:
width "80"- "90"; width "90+", "100"
- extra charge for the CPL 0.7 mm laminate*:
width "80"- "90"; width "90+", "100"
- decorative elements, surface-mounted door closer, electromagnetic lock by DORMAKABA, reed switch - p. 203-207
- GARDA handle colour change to black
- GARDA upper rose colour change to black
- class 6 cylinder colour change to black
- "100" door width **+10%**
- door higher by 100 mm **+10%**
- edging colour change to the colour of grey, graphite, black
- panoramic viewer - stainless steel;
brass, anthracite, black matt
- GARDA handle in the colour of inox (RC3 INVEST 37 dB door)
- GARDA rose in the colour of inox (RC3 INVEST 37 dB door)
- complete set of cylinders in the colour of inox (RC3 INVEST 37 dB door)

* extra charge to standard door height

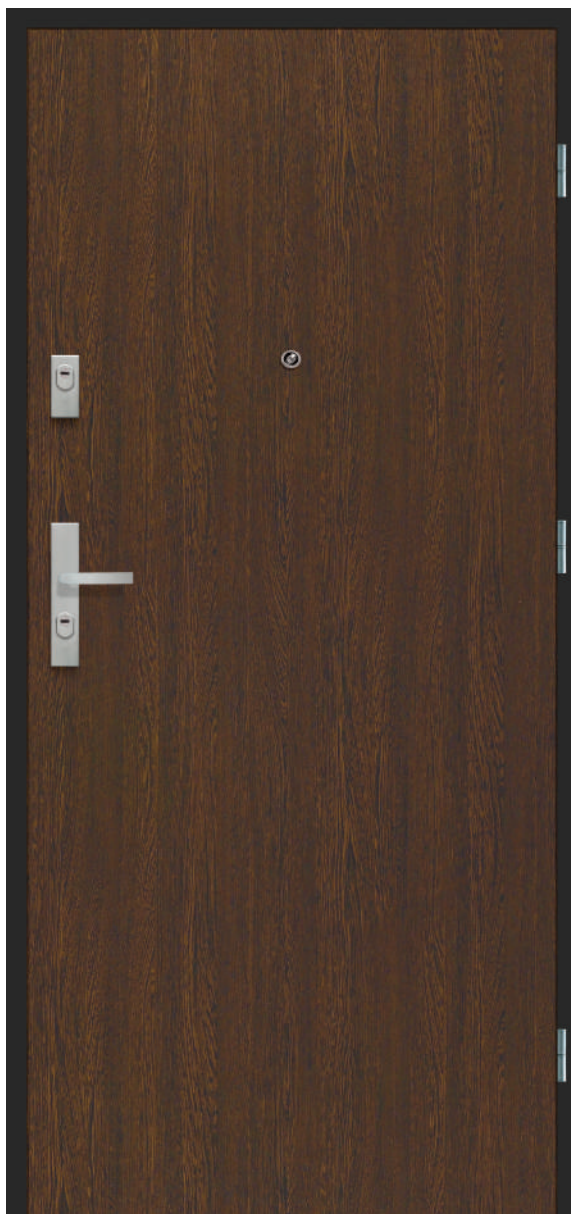
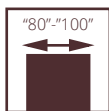

CERBER PLUS RC2 door, 00 pattern, fixed metal door frame

BURGLAR-PROOF DOOR POL-SKONE

CERBER PLUS RC2

Interior entrance door leading from corridors or staircases to e.g. flats in multi-family buildings or rooms in public utility buildings.

Door with a fixed and adjustable wooden door frame or metal door frame. Door leaf built of a **wooden rail and stile set** topped with two HDF boards. The in-fill is made of perforated board, optionally solid board or special POL-SKONE structure (37dB version). The rated door leaf thickness is 46 mm.

acoustic insulation capacity:
class D1 – 25, D2 – 25, **class Rw=27 dB** (in-fill: perforated or solid board, door with threshold or drop seal)
class D1 – 30, D2 – 30, **class Rw=37 dB** (in-fill: POL-SKONE door with a drop seal)
class D1 – 35, D2 – 30, **class Rw=37 dB** (in-fill: POL-SKONE door with threshold)
burglary resistance: class RC2 acc. to PN-EN 1627:2012
mechanical strength class 3 acc. to PN-EN 1192:2001
National Technical Assessment ITB-KOT-2019/0742 issue 1



CERBER PLUS RC2 door, 00 pattern, fixed wooden one-sidedly adjustable door frame



CERBER PLUS RC2



**ADJUSTABLE DOOR FRAME
FOR ENTRANCE DOOR
- p. 174**

VERSION	flush 00	37 dB 00
	with fixed wooden frame	with fixed metal frame
	with fixed metal frame	with fixed metal frame

UNI MAT PLUS

LAMINATED CPL 0.2 mm

LAMISTONE CPL

SILKSTONE

SILKSTONE CPL 0.5 mm

PAINTED - white

PAINTED - grey, beige

PAINTED - black, sage

VENEERED GROUP A

VENEERED GROUP B

VENEERED GROUP C, D

SILKWOOD

The technical parameters refer to a set including a door leaf, a metal door frame and a threshold. In order to comply with the national technical assessment conditions, it is required to purchase a complete door set, i.e. a door leaf, a door frame and a threshold.

Colours of metal door frames (p. 223)

extra charge CPL 0.5 mm, CPL 0.7 mm to door in CPL laminate coating (extra charge to standard door height)

CPL 0.5 mm ("60" - "90")	CPL 0.7 mm ("60" - "90")	CPL 0.5 mm ("90+" - "110")	CPL 0.7 mm ("90+" - "110")

extra charge added to the basic colour, white (RAL 9003) acc. to RAL, NCS colour groups (p. 264)

Group I	Group II	Group III	Group IV	Group V

metal door frame

wooden oak threshold

**DOOR PRICE = DOOR LEAF PRICE
+ DOOR FRAME PRICE + THRESHOLD PRICE**



multi-point lock



multi-point lock



hinge



oak threshold for wooden door frame

DOOR DIMENSIONS

Door with fixed or adjustable wooden door frame:

895x2067 mm, 995x2067 mm, 895x2000 mm, 995x2000 mm, 895x1950 mm, 995x1950 mm

max. width 1095 mm, max. height 2267 mm

Door with metal door frame:

917x2078 mm, 1017x2078 mm, 917x2011 mm, 1017x2011 mm, 917x1961 mm, 1017x1961 mm

max. width 1117 mm, max. height 2278 mm

WIDTH FOR PUBLIC UTILITY BUILDINGS

90 Plus width - 1005x2067 mm.

The 1005 mm door width provides a min. clearance of 900 mm for doors with the 90-degree opening angle.

WIDTH FOR PUBLIC UTILITY BUILDINGS

90 Plus width - 1027x2078 mm.

The 1027 mm door width provides a min. clearance of 900 mm for doors with the 90-degree opening angle.

DOOR LEAF FINISH

Plain surface painted, veneered, covered with CPL laminate with a thickness of 0.2 to 0.7 mm, HPL laminate with a thickness of 0.7 to 1.0 mm or wood-alike foil.

Flat decorations made of decorative profiled mouldings available, aluminium decors.

DOOR FRAMES

Door frame painted, veneered, covered with CPL 0.15 mm, CPL 0.2 mm laminate or foil matched to the colour of the door leaf.
Fixed wooden pine door frame - optionally with masking strips, quarter round.

Wooden adjustable door frame with widening panels, angle architraves and a masking strip.

Fixed metal door frame made of 1.5 mm thick DC01 metal sheet powder-coated in white (RAL 9016 and RAL 9003), grey (RAL 7047), brown (RAL 8014), beige (RAL 1001), graphite (RAL 7024), black (RAL 9005). Door frames painted in non-standard colours from RAL or NCS palettes are available upon consultation with the Sales Department.

ACCESSORIES AND EQUIPMENT

Standard equipment

Door with (fixed or adjustable) wooden door frame:

- adjustable screw-in pivot hinges - 3 pcs
- four-point bolt lock
- reinforced adjustable striker plates (except doors with a metal door frame)
- security bolts - 3 pcs
- viewfinder Ø 15
- oak threshold in the colour of natural oak, black, grey, brown with an aluminium strip provided for protection against excessive wear (for wooden door frame)
- oak threshold (applicable to metal door frame)

Additional equipment

- solid board in-fill
- aluminium decors - p. 201 (except version 37dB)
- complete set of minimum class 4 cylinders
- minimum class 2 handles and roses
- drop seal (without a threshold)
- decorations - p. 186

- hinge caps (1 piece):

- white/brown, chrome/nickel matt
- change of oak threshold to stainless steel threshold (applicable to metal door frame)
- GARDA handle in the colour of black
- GARDA handle in the colour of inox
- GARDA upper rose in the colour of black
- GARDA upper rose in the colour of inox
- a set of class 6 cylinders in the colour of black
- a set of class 6 cylinders in the colour of nickel-matt
- width 1095 mm **+10%** (wooden door frame)
- width 1117 mm **+10%** (metal door frame)
- height 2167 mm **+10%** (wooden door frame)
- height 2178 mm **+10%** (metal door frame)
- height 1950 mm **+10%** (wooden door frame)
- height 1961 mm, 2011 mm **+10%** (metal door frame)
- height 2267 mm **+20%** (wooden door frame)
- height 2278 mm **+20%** (metal door frame)
- edging colour change to the colour of grey, graphite, black
- panoramic viewer - stainless steel; brass, anthracite, black matt

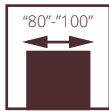

INTERIOR ENTRANCE CERBER PLUS

Door with wooden or metal door frame. Door leaf built of a wooden rail and stile set topped with two HDF boards. The in-fill is made of perforated board, optionally solid board or special POL-SKONE structure (37dB version). Rated leaf thickness: 46 mm.

acoustic insulation capacity:
class D1 - 25, D2 - 25, class **Rw=27 dB** (in-fill perforated or solid board, door with threshold or drop seal)
class D1 - 30, D2 - 30, class **Rw=37 dB** (in-fill POL-SKONE door with a drop seal)
class D1 - 35, D2 - 30, class **Rw=37 dB** (in-fill POL-SKONE door with threshold)
mechanical class 3 acc. to the PN-EN 1192:2001 standard
National Technical Assessment ITB-KOT-2019/0742 issue 1

CERBER PLUS door, 00 pattern, fixed wooden door frame



CERBER PLUS door, 00 pattern, one-sidedly adjustable wooden door frame



**ADJUSTABLE DOOR FRAME
FOR ENTRANCE DOOR**
- p. 174

VERSION	flush 00		37 dB 00	
	with fixed wooden frame	with door frame fixed metal	with fixed wooden frame	with door frame fixed metal

- UNI MAT PLUS
- LAMINATED CPL 0.2 mm
- LAMISTONE CPL
- SILKSTONE
- SILKSTONE CPL 0.5 mm
- PAINTED – white
- PAINTED – grey, beige
- PAINTED - black, sage
- VENEERED GROUP A
- VENEERED GROUP B
- VENEERED GROUP C, D
- SILKWOOD
- Colours of metal door frames (p. 223)

extra charge CPL 0.5 mm, CPL 0.7 mm to door in CPL laminate coating (extra charge to standard door height)

CPL 0.5 mm ("60" - "90")	CPL 0.7 mm ("60" - "90")	CPL 0.5 mm ("90+" - "110")	CPL 0.7 mm ("90+" - "110")
-----------------------------	-----------------------------	-------------------------------	-------------------------------

The technical parameters refer to a set including a door leaf, a metal door frame and a threshold.
In order to comply with the national technical assessment conditions, it is required to purchase a complete door set, i.e. a door leaf, a door frame and a threshold.

metal door frame
wooden oak threshold

extra charge added to the basic colour white (RAL 9003) acc. to RAL, NCS colour groups (p. 264)

Group I	Group II	Group III	Group IV	Group V
---------	----------	-----------	----------	---------



handle



upper rose



upper rose



oak threshold

DOOR DIMENSIONS

Door with fixed or adjustable wooden door frame:
895x2067 mm, 995x2067 mm, 895x2000 mm, 995x2000 mm
895x1950 mm, 995x1950 mm
"100" door max. width -1095 mm, max. height 2267 mm

Door with metal door frame:
917x2078 mm, 1017x2078 mm, 917x2011 mm, 1017x2011 mm,
917x1961 mm, 1017x1961 mm
"100" door max. width -1117 mm, max. height 2278 mm

WIDTH FOR PUBLIC UTILITY BUILDINGS
90 Plus width - 1005 mm
The 1005 mm door width provides a min. clearance of 900 mm for doors with the 90-degree opening angle.

WIDTH FOR PUBLIC UTILITY BUILDINGS
NOTE! 90 Plus width - 1027 mm
The 1027 mm door width provides a min. clearance of 900 mm for doors with the 90-degree opening angle.

DOOR LEAF FINISH

Plain surface painted, veneered, covered with CPL laminate with a thickness of 0.2 to 0.7 mm, HPL laminate with a thickness of 0.7 to 1.0 mm or wood-alike foil. Flat decorations made of decorative profiled mouldings available, aluminium decors.

DOOR FRAMES

Door frame painted, veneered, covered with CPL 0.15 mm, CPL 0.2 mm laminate or foil matched to the colour of the door leaf.
Fixed wooden pine door frame - optionally with masking strips, quarter round.
Wooden adjustable door frame with widening panels, angle architraves and a masking strip.

Fixed metal door frame made of 1.5 mm thick DC01 metal sheet powder-coated in white (RAL 9016 and RAL 9003), grey (RAL 7047), brown (RAL 8014), beige (RAL 1001), graphite (RAL 7024), black (RAL 9005).
Door frames painted in non-standard colours from RAL or NCS palettes are available upon consultation with the Sales Department.

ACCESSORIES AND EQUIPMENT

- Standard equipment:**
Door with wooden door frame
- pivot hinges adjustable in 3 planes by OTLAV - 3 pcs
- two independent three-bolt cylinder locks
- security bolts - 2 pcs
- viewer Ø15
- oak threshold in the colour of natural oak, black, grey, brown with an aluminium strip to provide protection against excessive wear
- reinforced striker plates for locks
Door with metal door frame
- pivot hinges adjustable in 3 planes by OTLAV - 3 pcs
- two independent three-bolt cylinder locks
- security bolts - 2 pcs
- viewer Ø15
- oak threshold in the colour of natural oak, black, grey, brown
Additional equipment:
- solid board in-fill
- hinges with the closing function (only for the wooden door frame)
- drop seal (without a threshold)
- hinge caps (1 piece):
white/brown, chrome/nickel matt

- change of oak threshold to stainless steel threshold (applicable to metal door frame)
- aluminium decors, new patters - p. 201
- GARDA handle in the colour of inox
- GARDA upper rose in the colour of inox
- GARDA handle in the colour of black
- GARDA upper rose in the colour of black
- a set of class 6 cylinders in the colour of black
- a set of class 6 cylinders in the colour of nickel-matt
- width 1095 mm **+20%** (wooden door frame)
- height 2167 mm **+10%** (wooden door frame)
- height 2267 mm **+20%** (wooden door frame)
- width 1117 mm **+10%** (metal door frame)
- height 2178 mm **+10%** (metal door frame)
- height 2278 mm **+20%** (metal door frame)
- height 1950 mm, 2000 mm **+10%** (wooden door frame)
- edging colour change to the colour of grey, graphite, black
- panoramic viewer - stainless steel; anthracite, black matt
- decorations - p. 186



ACOUSTIC POL-SKONE

TYPE A / TYPE A DUO TYPE B / TYPE B DUO

Single-leaf **SOUNDPROOF** door in the rebated system. The leaf structure consists of a rail and stile set made of coniferous wood, topped with HDF boards on both sides. The in-fill is made of solid chipboard (type A) or the special POL-SKONE structure (type B). Leaf with drop seal.

Single- or double-leaf **SOUNDPROOF DUO** door in the non-rebated system. The leaf structure consists of a rail and stile set made of coniferous wood, topped with HDF boards on both sides. The in-fill is made of solid chipboard (type A) or the special POL-SKONE structure (type B). The door is available in the single- and double-leaf version with a wooden frame (DUO fixed or DUO adjustable). Leaf with drop seal.

mechanical class: class 2 of mechanical resistance requirements, i.e. medium service conditions
National Technical Assessment ITB-KOT-2021/2041 release 1

	ACOUSTIC INSULATION CAPACITY R_w [dB]		
	door frame DIN	wooden door frame	metal door frame
TYPE A	27	27	27
TYPE B	37	32	37
TYPE A DUO (single- and double-leaf door)	-	27	-
TYPE B DUO (single-leaf variant)	-	37	-
TYPE B DUO (double-leaf variant)	-	32	-

TYPE A door, 00 pattern, DIN SYSTEM adjustable door frame



TYPE A door, 00 pattern, DIN SYSTEM adjustable door frame

**DOOR LEAF
TYPE A/TYPE B**



VERSION	TYPE A	TYPE B
UNI MAT PLUS		
LAMISTONE CPL		
SILKSTONE		
SILKSTONE CPL 0.5 mm		
LAMINATED CPL 0.2 mm		
PAINTED white*		
PAINTED beige, grey		
PAINTED black, sage		
VENEERED GROUP A		
VENEERED GROUP B		
VENEERED GROUP C, D		
extra charge added to the basic colour white (RAL 9003) acc. to RAL, NCS colour groups (p. 264)		
Group I	Group II	Group III
Group IV	Group V	

**EXTRA CHARGES FOR NON-STANDARD
DIMENSIONS OF SOUNDPROOF DOORS**

DIN adjustable door frame	
height to 2143 mm - extra charge 10%*	
height to 2243 mm - extra charge 20%*	
height to 2300 mm - extra charge 30%*	
wooden (fixed or adjustable)	
height 2164 mm (fixed) or 2167 mm (adjustable) - extra charge 10%*	
height 2264 mm (fixed) or 2267 mm (adjustable) - extra charge 20%*	
height 2143 mm (fixed) - extra charge 30%*	
height 2464 mm, 2500 mm (fixed) - extra charge 40%*	
metal door frame (fixed FD12 or adjustable)	
height 2168 mm (fixed) or 2178 mm (adjustable) - extra charge 10%**	
height 2268 mm (fixed) or 2278 mm (adjustable) - extra charge 20%**	
DUO door frame (fixed or adjustable)	
height 2183 mm - extra charge 10%**	
height 2283 mm - extra charge 20%**	
height 2383 mm (fixed) - extra charge 30%***	
height 2483 mm, 2500 mm (fixed) - extra charge 40%***	
* extra charge to door (door leaf+door frame)	
** extra charge to door (door leaf+door frame)	
+ extra charge for additional hidden hinge (1 piece)	
*** extra charge to door (door leaf+door frame) + extra charge for additional hidden hinge (2 piece)	
Colours of metal door frames (p. 223)	

QUANTITY OF HINGES FOR SOUNDPROOF DOOR

DIN adjustable door frame (type K)	wooden fixed or adjustable door frame (type C)	metal fixed FD12 or adjustable door frame (type M)	DUO fixed or adjustable door frame (hidden hinge)
height [mm] / quantity of hinges			
height 2043 - 3 pcs for a width of "60"-90"	height 2064 mm (fixed), 2067 mm (adjustable) - 3 pcs for a width of "60"-90"	height 2068 mm (fixed), 2078 mm (adjustable) - 3 pcs for a width of "60"-100"	height 2083 - 2 pcs, width "60"-80" - 3 pcs, width "90"-100"
height 2143 - 3 pcs	height 2164 mm (fixed), 2167 mm (adjustable) - 3 pcs	height 2168 mm (fixed), 2178 mm (adjustable) - 3 pcs	height 2183 - 3 pcs
height 2243 - 4 pcs	height 2264 mm (fixed), 2267 mm (adjustable) - 4 pcs	height 2268 mm (fixed), 2278 mm (adjustable) - 4 pcs	height 2283 - 3 pcs
height 2300 - 4 pcs	height 2364 mm (fixed) - 4 pcs	-	height 2383 mm (fixed) - 4 pcs
-	height 2464 mm (fixed) - 4 pcs	-	height 2483 mm (fixed) - 4 pcs
-	height 2500 mm (fixed) - 4 pcs	-	height 2500 mm (fixed) - 4 pcs

Non-standard heights (maximum height of door with DIN frame - 2300 mm - 4 pcs; maximum height of door with wooden frame - 2500 mm)

DOOR DIMENSIONS	TYPE A, TYPE B	TYPE A Duo, TYPE B Duo
Wooden fixed door frame:	max. width "110" - 1189 mm, max. height 2500 mm	Wooden fixed or adjustable DUO door frame:
Wooden adjustable door frame:	max. width "110" - 1195 mm, max. height 2267 mm	Single-leaf door:
DIN adjustable door frame:	max. width "100" - 1046 mm, max. height 2300 mm	max. width "100" - 1093 mm, max. height 2500 mm
Metal adjustable door frame:	max. width "110" - 1217 mm, max. height 2278 mm	Double-leaf door:
Metal fixed door frame FD12:	max. width: "110" - 1197 mm, max. height 2268 mm	max. width "100+100" - 2108 mm, max. height 2500 mm

DOOR LEAF FINISH Plain surface painted, veneered, covered with CPL laminate with a thickness of 0.2 to 0.7 mm, HPL laminate with a thickness of 0.7 to 1.0 mm or wood-alike foil. Flat decorations made of decorative profiled mouldings, aluminium decors available (only version TYPE A).

DOOR FRAMES	DOOR FRAMES
Door frame painted, veneered, covered with CPL 0.15 mm laminate or foil matched to the colour of the door leaf.	FD12 fixed metal door frame made of 1.5 mm thick steel sheet with rabbet seal.
Fixed wooden pine door frame - optionally with masking strips, quarter round.	Adjustable metal door frame made of sheet steel of a thickness of 1.5 mm
Wooden adjustable door frame with widening panels and angular architraves	Door frames, standard powder-coated in the colour of white (RAL 9016 and RAL 9003), grey (RAL 7047), brown (RAL 8014), beige (RAL 1001), graphite (RAL 7024), black (RAL 9005).
DIN adjustable door frame - made of 22 mm thick MDF panels.	Door frames painted in non-standard colours from RAL or NCS palettes are available upon consultation with the Sales Department. The door frame consists of a major part and an angular architrave inserted into the major part.
Wooden adjustable DUO door frame with widening panels and angular architraves	
Wooden fixed DUO pine door frame (TYPE A Duo, TYPE B Duo) - optionally with masking strips, quarter round.	

ACCESSORIES AND EQUIPMENT	ACCESSORIES AND EQUIPMENT
Standard equipment:	Additional equipment:
TYPE A, TYPE B	- surface-mounted door closer
- pivot hinges adjustable in 3 planes by TKZ Polska	- additional mortise or surface-mounted lock
- latch-and-deadbolt lock for cylinder or key	- NC or NO electric doorstrike (TYPE A, TYPE B)
- drop seal	- electromagnetic lock
TYPE A Duo, TYPE B Duo	- panoramic viewer - stainless steel; brass, anthracite, black matt
- hidden hinge (adjustable in 3 planes)	- electronic hotel locks
- magnetic lock for cylinder or key for single-leaf door	- width "100" +20%
- latch-and-deadbolt lock for cylinder or key for double-leaf door	- width "110" +40%
- drop seal	- door higher by 50 mm or 100 mm +10%
	- door higher by 150 mm or 200 mm +20%
	- door higher by 250 mm or 300 mm +30%
	- door higher by 350 mm or 400 mm +40%
	- door higher by 50 mm or 100 mm (rebated sys.) +20%
	- door lower by 55 mm or 100 mm (non-rebated sys.) +20%
	- double-leaf door - no possibility to use doorstrike

**No possibility to use stainless steel shields on leaf edges.
No possibility to use aluminium decors in version TYPE B.**

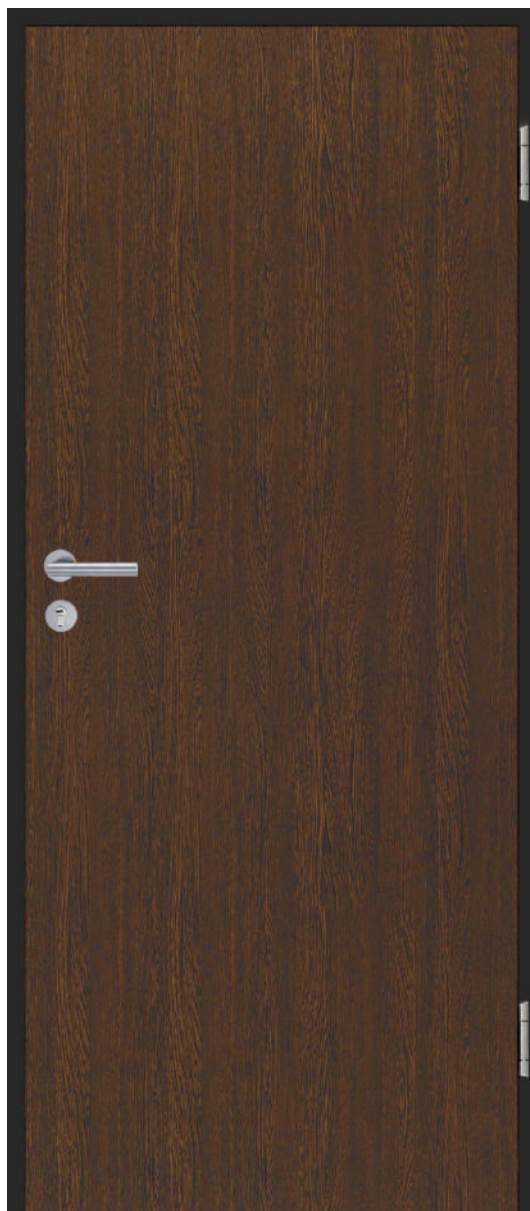
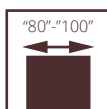

ACOUSTIC
POL-SKONE

AKUSTIK 42 dB



Door leaf made of chipboard covered with HDF board on both sides. Rated leaf thickness: 57 mm. Door leaf additionally equipped with drop seals as standard.

- acoustic insulation capacity: class $D_1 - 35$, $D_2 - 35$, class $R_w=42$ dB
- class 4 mechanical strength acc. to the PN-EN 1192:2001 standard
- class 5 mechanical strength 100 000 cycles
- door approved for marketing based on the PN-EN 14351-2:2018 standard

AKUSTIK 42 dB door, fixed metal door frame



AKUSTIK 42 dB door, fixed metal door frame

AKUSTIK 42 dB



AKUSTIK METAL FIXED DOOR FRAME

"80", "90", "90 plus"

"100"

AKUSTIK METAL ADJUSTABLE DOOR FRAME

symbol	range in mm	"80", "90", "90 plus"	"100"
SR1	110-140		
SR2	140-170		
SR3	170-200		
SR4	200-230		
SR5	230-260		
SR6	260-290		
SR7	290-320		
SR8	320-350		

Colours of metal door frames (p. 223)

VERSION

flush 42 dB

LAMINATED CPL 0.2 mm

UNI MAT PLUS

LAMISTONE

SILKSTONE

SILKSTONE CPL 0.5 mm

PAINTED - white

PAINTED - grey, beige

PAINTED - black, sage

VENEERED GROUP A

VENEERED GROUP B

VENEERED GROUP C, D

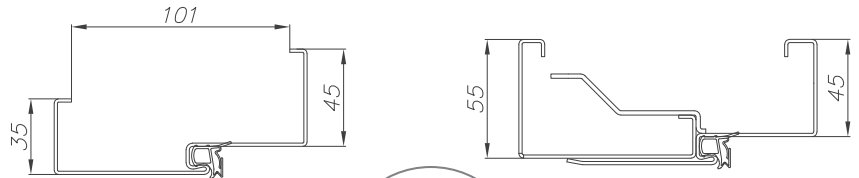

extra charge added to the basic colour, white (RAL 9003)
acc. to RAL, NCS colour groups (p. 264)

Group I	Group II	Group III	Group IV	Group V
---------	----------	-----------	----------	---------

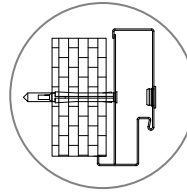

anchor installation hole
in the centre of the profile on
the door frame body

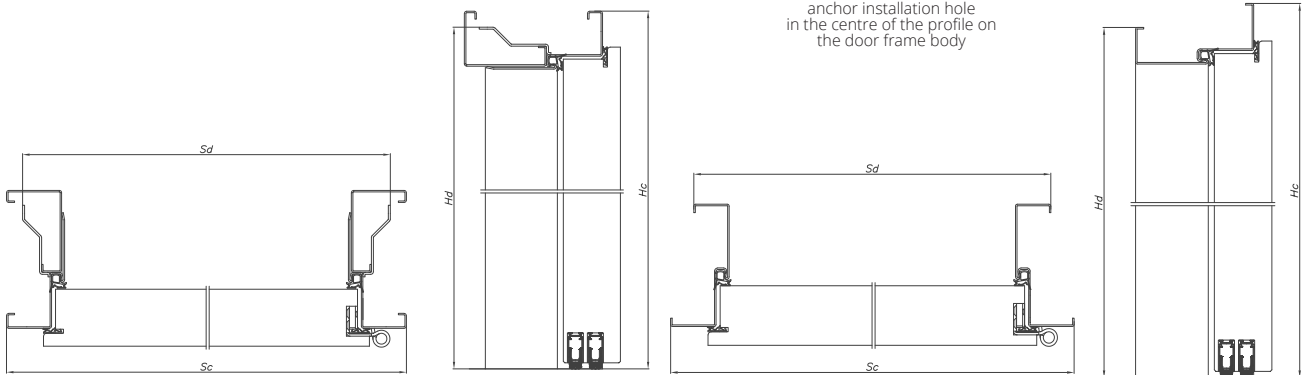

AKUSTIK METAL ADJUSTABLE DOOR FRAME

WIDTH	Sc	Sd	So
"80"	922	891	897
"90"	1022	991	997
"90 plus"	1042	1011	1017
"100"	1122	1091	1097
	Hc	Hd	Ho
HEIGHT	2080	2064	2067

AKUSTIK METAL FIXED DOOR FRAME

WIDTH	Sc	Sd	So
"80"	922	876	895
"90"	1022	976	995
"90 plus"	1042	996	1015
"100"	1122	1076	1095
	Hc	Hd	Ho
HEIGHT	2080	2057	2067

DOOR DIMENSIONS

Door with the metal door frame:

Single-leaf door:
max. width of "100" - 1122 mm, max. height 2180 mm
Door of non-standard dimension is available - subject to
consultation with the Sales Department

DOOR LEAF FINISH

Plain surface painted, veneered, covered with CPL laminate with a thickness of 0.2 to 0.7 mm, HPL laminate with a thickness of 0.7 to 1.0 mm or wood-alike foil. Decorations made of decorative profiled mouldings available.

DOOR FRAMES

Fixed or adjustable metal door frame made of 1.5 mm thick DC01 metal sheet powder-coated in white (RAL 9016 and RAL 9003), grey (RAL 7047), brown (RAL 8014), beige (RAL 1001), graphite (RAL 7024), black (RAL 9005).

ACCESSORIES AND EQUIPMENT

Standard equipment:

- object 3D hinges by ECO SCHULTE, OBX type - 2 pcs.
- LOB mortise lock
- drop seals 2 pcs.

Additional equipment:

- extra charge for CPL 0.5 mm laminate*:
width "80"- "90"; width "90+"-"100"
- extra charge for CPL 0.7 mm laminate*:
width "80"- "90"; width "90+"-"100"
- width "100" - 1112 mm **+10%**
- panoramic viewer - stainless steel;
- anthracite, black matt
- electric NC, NO strike mounted on auxiliary lock, hotel locks, electromagnetic lock, reed switch, surface-mounted door closer, cylinder, decorations, stainless steel panels, decors

* extra charge to standard door height

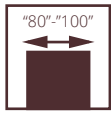

ACOUSTIC POL-SKONE SR 37 dB

Door leaf in rebated system. The leaf structure consists of a rail and stile set made of coniferous wood, topped with HDF boards on both sides. The in-fill is a special Pol-Skone structure. The rated door leaf thickness is 56 mm.

- acoustic insulation**
- class $D_1 - 35, D_2 - 35$, class $R_w=37$ dB
 - class 4 mechanical strength acc. to the PN-EN 1192:2001 standard (door SR 37dB)
 - National Technical Assessment ITB-KOT-2018/0713 issue 1 (single-leaf door)

SR 37 dB acoustic door, fixed wooden door frame



SR 37 dB door, adjustable wooden door frame

SR 37 dB



VERSION flush 37 dB

- LAMINATED CPL
- UNI MAT PLUS
- LAMISTONE
- SILKSTONE
- SILKSTONE CPL 0.5 mm
- PAINTED – white
- PAINTED – grey, beige
- PAINTED - black, sage
- VENEERED GROUP A
- VENEERED GROUP B
- VENEERED GROUP C, D

Colours of metal door frames (p. 223)

extra charge added to the basic colour, white (RAL 9003)
acc. to RAL, NCS colour groups (p. 264)

Group I	Group II	Group III	Group IV	Group V
---------	----------	-----------	----------	---------

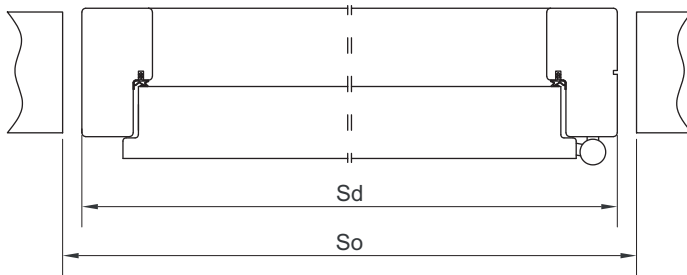

door width	Sd	So
"80"	912	940
"90"	1012	1040
"90 plus"	1032	1060
"100"	1112	1140

DOOR DIMENSIONS

Fixed or adjustable wooden door frame:
Single-leaf door:
max. width of "100" – 1112 mm, max. height 2175 mm

DOOR LEAF FINISH

Plain surface painted, veneered, covered with CPL laminate with a thickness of 0.2 to 0.7 mm, HPL laminate with a thickness of 0.7 to 1.0 mm or wood-alike foil.
Flat decors, made of decorative profiled mouldings, aluminium decors available (subject to the consultation with the Sales Department).

DOOR FRAMES

Door frame painted, veneered, covered with CPL 0.15 mm laminate or foil matched to the colour of the door leaf.

Fixed wooden pine door frame - optionally with masking strips, quarter round.

Wooden adjustable door frame with widening panels, angle architraves and a masking strip.

ACCESSORIES AND EQUIPMENT

Standard equipment:
SR 37 dB single-leaf door:
- pivot hinges adjustable in 3 planes
- mortise lock
- oak threshold in the colour of natural oak, black, grey, brown with an aluminium strip to provide protection against excessive wear

Additional equipment:
- aluminium decors, decorations
- extra charge for CPL 0.5 mm laminate*:
width "80"- "90"; width "90+"-"100"
- extra charge for CPL 0.7 mm laminate*:
width "80"- "90"; width "90+"-"110"
- hidden automatic door closer
- additional mortise or surface-mounted lock
- NC or NO electric doorstrike
- electromagnetic locks
- electronic locks
- cylinders
- width "100" - 1112 mm **+10%**
- height of 2175 mm **+10%**
- panoramic viewer - stainless steel;
anthracite, black matt

* extra charge to standard door height

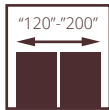
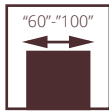

POL-SKONE REBATED FIRE PROTECTION DOORS

FR EI30

Pol-Skone system
with or without sidelights/toplights

NOTE! In order to meet the fire resistance conditions, use a door closer compliant with the requirements of the PN-EN 1154:1999/A1:2004/AC:2010 standard, door handles compliant with the requirements of the PN-EN 1906:2012 standard (min. class B with regard to fire resistance) and cylinders compliant with the requirements of the PN-EN 1303:2015 standard (class B with regard to fire resistance).

The doors are designed for use as interior entrance doors in residential buildings, collective dwellings, public utility and industrial buildings to close openings in interior walls, between staircases or corridors and rooms as determined by the PN-B-91000:1996 standard.

Door leaf in rebated system. The leaf structure consists of a rail and stile set made of coniferous wood, topped with HDF boards on both sides. The in-fill is a special Pol-Skone structure. The nominal leaf thickness is 50 mm for doors with $R_w = 32$ dB.

- Fire resistance EI₂30
- Acoustic insulation capacity class D₁ - 30, D₂ - 25, class $R_w=32$ dB
- class 3 mechanical strength acc. to the PN-EN 1192:2001 standard
- National Technical Assessment ITB-KOT-2020/1370 issue 1
- National Certificate of Constancy of Performance no 020-UWB-1937/W

FR EI30 door, fixed wooden door frame



FR EI30 fire door, fixed wooden door frame

FR EI30



Exemplary hotel locks for FR EI30 door:

- Signature or Classic series by VingCard,
- LE8P series + XS4 series handle with access control by Salto,
- LOB 5500 Adel series, LOB 8005 series, LOB 8002 series by ASSA ABLOY Opening Solutions Poland S.A.
- HDL MF 20 series, HDL MF 20 N series, HDL MF 65 series by Hartmann Tresore,
- Be-Tech 6536M-65A series, Be-Tech Guardian RFID Elegant series, Be-Tech G1 series by Guangdong BeTech Security Systems Co. LTD,
- Ilco 790 RFID series, Saflok RT series, Saflok Quantum RFID series by Dormakaba,
- Trillium series, Advance series by Onity,

PATTERN

EI30 SR 32

EI30-1S

LAMINATED CPL 0.2 mm
UNI MAT PLUS
LAMISTONE
SILKSTONE
SILKSTONE CPL 0.5 mm
PAINTED – white
PAINTED – grey, beige
PAINTED - black, sage
VENEERED GROUP A
VENEERED GROUP B
VENEERED GROUP C, D

extra charge CPL 0.5 mm, CPL 0.7 mm to door in CPL laminate coating (extra charge to standard door height)

CPL 0.5 mm ("60" - "90")	CPL 0.7 mm ("60" - "90")	CPL 0.5 mm ("90+" - "110")	CPL 0.7 mm ("90+" - "110")
-----------------------------	-----------------------------	-------------------------------	-------------------------------



PATTERN

EI 30-2

EI30-2S

EI30-3S

LAMINATED CPL
UNI MAT PLUS
LAMISTONE
SILKSTONE
SILKSTONE CPL 0.5 mm
PAINTED – white
PAINTED – grey, beige
PAINTED - black, sage
VENEERED GROUP A
VENEERED GROUP B
VENEERED GROUP C, D

*standard colour for wooden leaves and frames - white RAL 9003.

extra charge added to the basic colour white (RAL 9003) acc. to RAL, NCS colour groups (p. 264)

Group I	Group II	Group III
Group IV	Group V	

SIDELIGHTS AND TOPLIGHTS

price per 1m

ECO TOP
LAMINATED CPL
HIGH TOP
LAMISTONE
SILKSTONE
PAINTED – white
PAINTED – grey, beige
PAINTED - black, sage
VENEERED GROUP A
VENEERED GROUP B
VENEERED GROUP C, D

Sidelights and toplight on the fixed door frame profile 100mm x 55mm with EI30 fire resistance, maximum size of sidelights: 944mm x 2175mm, maximum size of toplights: 2152mm x 425mm, minimum size of a single sidelight/skylight side: 300mm (price per 1 m)
standard: transparent fireproof glass (m²):

Acoustic test result for FR EI30 flush single-leaf Pol-Skone system door with sidelight is $R_w(C, Ctr) = 32 (0;-1)$ dB.

Acoustic test result for FR EI30 glazed single-leaf Pol-Skone system door with sidelight is $R_w(C, Ctr) = 35 (0;-1)$ dB.

**sidelight/toplight price = price of 1mbx2 (A+B)
+ price of 1sq.m. of glass x A X B**

DOOR DIMENSIONS

Fixed wooden or adjustable 1012x2075 mm door frame max. width "100" - 1112 mm, max. height 2175 mm

**WIDTH FOR PUBLIC UTILITY BUILDINGS
90 Plus width - 1032 mm.
The 1032 mm door width provides a min. clearance of 900 mm for doors with the 90-degree opening angle.**

Double-leaf door:

"30"+"90"* (1352 mm), "40"+"90"* (1452 mm), "50"+"90"* (1552 mm), "60"+"90"* (1652 mm), "70"+"90"* (1752 mm), "80"+"90"* (1852 mm), "90"+"90"* (1952 mm);

*Door leaf with a width of "30", "40", "50", "60" only in the flush version.

max. width "100"+"100" – 2152 mm, max. height 2175 mm

DOOR LEAF FINISH

Plain surface painted, veneered, covered with CPL laminate with a thickness of 0.2 mm to 0.7 mm, HPL laminate with a thickness of 0.7 mm to 1 mm or wood-alike foil. Flat decorations made of decorative profiled mouldings, aluminium decors available.

GLAZINGS

Transparent glass pane with EI30 fire resistance. Oak spacer painted, veneered or covered with foil in the colour matching the colour of the door leaf.

DOOR FRAMES

Door frame painted, veneered, covered with CPL 0.15 mm, CPL 0.2 mm laminate or foil matched to the colour of the door leaf.

Wooden pine fixed door frame - optionally with masking strips, quarter round.

Wooden adjustable door frame with widening panels, angular architraves and a masking strip.

ACCESSORIES AND EQUIPMENT

Standard equipment of FR EI30:

- pivot hinges adjustable in 3 planes
- mortise lock with cylinder
- drop seal

Additional equipment:

- decorations, stainless steel panels, aluminium decors
- EL560/EL561 electromotoric lock
- mortise coded (hotel) locks

- surface-mounted or hidden door closer
- additional mortise locks
- NC or NO electric doorstrikes
- reed switch
- electromagnetic lock
- electromagnetic holder



POL-SKONE NON-REBATED FIRE PROTECTION DOORS

FR EI30 SR

Pol-Skone system without sidelights/toplights

NOTE! In order to meet the fire resistance conditions, use a door closer compliant with the requirements of the PN-EN 1154:1999/A1:2004/AC:2010 standard, door handles compliant with the requirements of the PN-EN 1906:2012 standard (min. class B with regard to fire resistance) and cylinders compliant with the requirements of the PN-EN 1303:2015 standard (class B with regard to fire resistance).



acoustic insulation

The doors are designed for use as interior entrance doors in residential buildings, collective dwellings, public utility and industrial buildings to close openings in interior walls, between staircases or corridors and rooms as determined by the PN-B-91000:1996 standard.

Door leaf in non-rebated system. The leaf structure consists of a rail and stile set made of coniferous wood, topped with HDF boards on both sides. The in-fill is a special Pol-Skone structure. The rated door leaf thickness is 57 mm.

- Fire resistance EI₂30
- Acoustic insulation capacity class D₁ - 35, D₂ - 35, class Rw=37 dB
- class 3 mechanical strength acc. to the PN-EN 1192:2001 standard
- National Technical Assessment ITB-KOT-2020/1370 issue 1
- National Certificate of Constancy of Performance no 020-UWB-1937/W

FR EI30 SR door, fixed wooden door frame

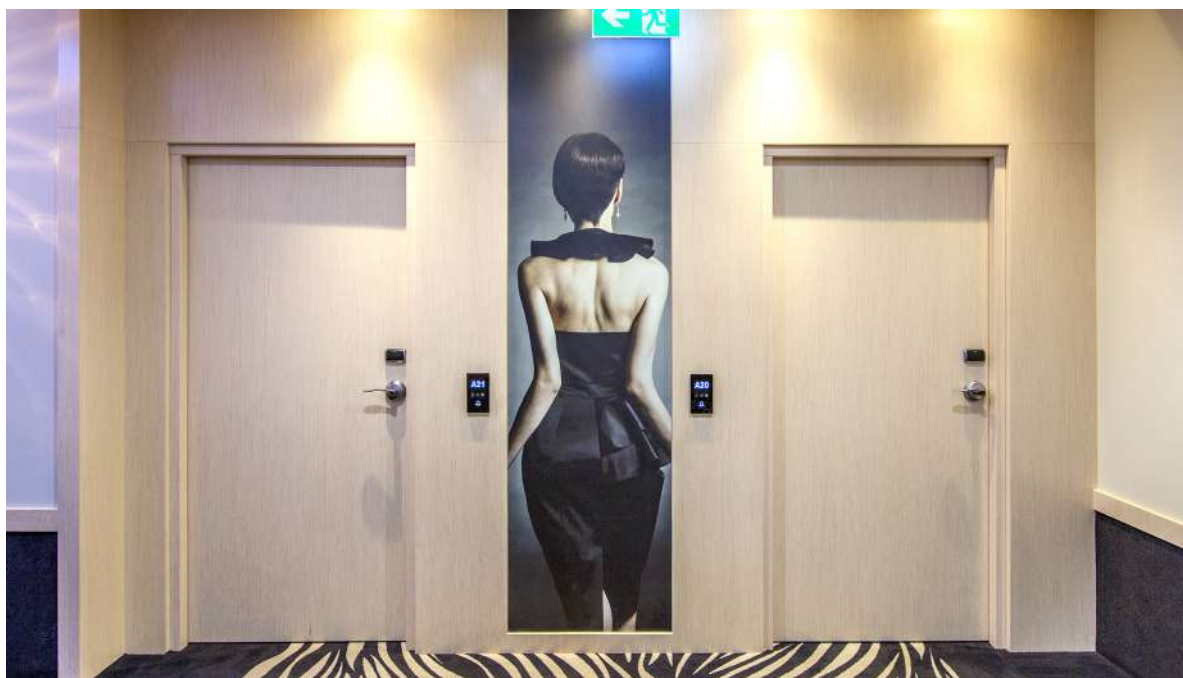

FR EI30 SR fire door, fixed wooden door frame

FR EI30 SR



VERSION EI30 SR

- LAMINATED CPL 0.2 mm
- LAMINATED CPL 0.5 mm
- UNI MAT PLUS
- LAMISTONE
- SILKSTONE
- SILKSTONE CPL 0.5 mm
- PAINTED – white
- PAINTED – grey, beige
- PAINTED - black, sage
- VENEERED GROUP A
- VENEERED GROUP B
- VENEERED GROUP C, D

Exemplary hotel locks for FR EI30 SR door:

- Signature or Classic series by VingCard,
- LE8P series + XS4 series handle with access control by Salto,
- LOB 5500 Adel series, LOB 8005 series, LOB 8002 series by ASSA ABLOY Opening Solutions Poland S.A.
- HDL MF 20 series, HDL MF 20 N series, HDL MF 65 series by Hartmann Tresore,
- Be-Tech 6536M-65A series, Be-Tech Guardian RFID Elegant series, Be-Tech G1 series by Guangdong BeTech Security Systems Co. LTD,
- Ilco 790 RFID series, Saflok RT series, Saflok Quantum RFID series by Dormakaba,
- Trillium series, Advance series by Onity,

extra charge added to the basic colour white (RAL 9003) acc. to RAL, NCS colour groups (p. 264)

Group I	Group II	Group III	Group IV	Group V

extra charge CPL 0.5 mm, CPL 0.7 mm to door in CPL laminate coating (extra charge to standard door height)

CPL 0.5 mm ("60" - "90")	CPL 0.7 mm ("60" - "90")	CPL 0.5 mm ("90+" - "110")	CPL 0.7 mm ("90+" - "110")

DOOR DIMENSIONS

Fixed wooden or adjustable door frame
1012x2075 mm
single-leaf door:
width "60" - "100" – 1112 mm, max. height 2175 mm

WIDTH FOR PUBLIC UTILITY BUILDINGS
90 Plus version (it allows getting a min. clearance of 900 mm for the door leaf with a 90° opening angle)
1072x2075 mm

DOOR LEAF FINISH

Plain surface painted, veneered, covered with CPL laminate with a thickness of 0.2 mm to 0.7 mm, HPL laminate with a thickness of 0.7 mm to 1 mm or wood-like foil. Flat decorations made of decorative profiled mouldings, aluminium decors available.

DOOR FRAMES

Door frame painted, veneered, covered with CPL 0.15 mm, CPL 0.2 mm laminate or foil matched to the colour of the door leaf.

Wooden pine fixed door frame - optionally with masking strips, quarter round.

Wooden adjustable door frame widening panels, angular architraves and a masking strip.

ACCESSORIES AND EQUIPMENT

Standard equipment of FR EI30:
- 3 object hinges, OBX type, by ECO SCHULTE
- mortise lock with cylinder
- 2 drop seals

Additional equipment:
- decorations, stainless steel panels, aluminium decors
- EL560/EL561 electromotoric lock
- mortise coded (hotel) locks
- surface-mounted or hidden door closer
- additional mortise locks
- NC or NO electric doorstrikes
- reed switch
- electromagnetic lock
- electromagnetic holder
- panic bar with surface-mounted or mortise lock
- width "100" **+10%**
- height of 2175 mm **+10%**



90 PLUS
WIDTH
FOR PUBLIC
UTILITY
BUILDINGS



FR EI30 door, fixed wooden door frame

FIRE PROTECTION DOORS ESCAPE DOORS

FR EI30 SR32 door

(single- and double-leaf door with a wooden door frame, flush or glazed)

- Fire resistance - EI₂30
- acoustic insulation class D₁ - 30, D₂ - 25, class Rw=32 dB
- Class 3 Mechanical strength acc. to standard PN-EN 1192:2001
- National Technical Assessment ITB-KOT-2020/1370 issue 1
- National Certificate of Constancy of Performance no 020-UWB-1937/W

Halspan system EI30 Plus door

(single- and double-leaf door with a metal door frame, flush or glazed)

- Fire resistance - EI₂30
- acoustic insulation capacity:
- single-leaf door - class D₁ - 30, D₂ - 25, class Rw=32 dB
- double-leaf door class D₁ - 25, D₂ - 25, class Rw=27 dB
- class 3 mechanical strength acc. to the PN-EN 1192:2001 standard
- National Technical Assessment ITB-KOT-2018/0407 issue 2
- National Certificate of Constancy of Performance no 020-UWB-2695/W

Halspan system EI60 Plus door

(single- and double-leaf door with a metal door frame, flush or glazed)

- Fire resistance - EI₂60
- acoustic insulation
- single-leaf door class D₁ - 30, D₂ - 25, class Rw=32 dB
- double-leaf door class D₁ - 25, D₂ - 25, class Rw=32 dB
- class 3 mechanical strength acc. to the PN-EN 1192:2001 standard
- National Technical Assessment ITB-KOT-2018/0407 issue 2
- National Certificate of Constancy of Performance no 020-UWB-2695/W



FR EI30 fire door, fixed wooden door frame

**PRICE OF POL-SKONE SYSTEM FIRE ESCAPE DOOR =
PRICE OF POL-SKONE SYSTEM FIRE DOOR
+ PRICE OF DORMAKABA PHA 2000 PANIC BAR (P. 205)
+ PRICE OF OBX TYPE OBJECT HINGES (P. 203)**

**PRICE OF EI30 PLUS, EI60 PLUS FIRE ESCAPE DOOR =
PRICE OF EI30 PLUS, EI60 PLUS FIRE DOOR
+ PRICE OF DORMAKABA PHA 2000 PANIC BAR (P. 205)**

WIDTH FOR PUBLIC UTILITY BUILDINGS
the 90 plus door width allows getting a min. clearance of 900 mm for doors with the 90-degree opening angle.

extra charge CPL 0.5 mm, CPL 0.7 mm to door in CPL laminate coating (extra charge to standard door height)

CPL 0.5 mm ("60" - "90")	CPL 0.7 mm ("60" - "90")	CPL 0.5 mm ("90+" - "110")	CPL 0.7 mm ("90+" - "110")
-----------------------------	-----------------------------	-------------------------------	-------------------------------

DOOR DIMENSIONS

FR EI30 SR32 door, rebated system

single-leaf door:
width "90" - "100" - 1012 - 1112 mm, max. height 2175 mm
The 90 Plus version (it allows getting a min. clearance of 900 mm for the door leaf with a 90° opening angle) width 1032 mm.
double-leaf door:
width "90+60" - "100+100" - 1653 - 2153 mm, max. height 2175 mm.

Halspan system EI30 Plus door, rebated system

fixed metal door frame
single-leaf door:
width "90" - "110" - 1004 - 1204 mm, max. height 2271 mm
The 90 Plus version (it allows getting a min. clearance of 900 mm for the door leaf with a 90° opening angle) width 1024 mm.
double-leaf door:
width "90+60" - "110+110" - 1642 - 2342 mm, max. height 2271 mm.
adjustable metal frame
single-leaf door:
width "90" - "110" - 1024 - 1224 mm, max. height 2281 mm
The 90 Plus version (it allows getting a min. clearance of 900 mm for the door leaf with a 90° opening angle) width 1044 mm.
double-leaf door:
width "90+60" - "110+110" - 1662 - 2362 mm, max. height 2281 mm.

EI60 Plus door in Halspan system, rebated system

metal fixed door frame.
single-leaf door:
width "90" - "110" - 1004-1204 mm, max. height 2271 mm
The 90 Plus version (it allows getting a min. clearance of 900 mm for the door leaf with a 90° opening angle) width 1024 mm.
double-leaf flush door:
width "90+60" - "110+110" - 1642-2342 mm, max. height 2271 mm.
double-leaf glazed door: "90+60" - "100+100" - 1642-2142 mm, max. height 2271 mm.
metal adjustable door frame:
single-leaf door:
width "90" - "110" - 1024-1224 mm, max. height 2281 mm.
The 90 Plus version (it allows getting a min. clearance of 900 mm for the door leaf with a 90° opening angle) width 1044 mm.
double-leaf flush door
width "90+60" - "110+110" - 1662 - 2362 mm, max. height 2281 mm.
double-leaf glazed door: "90+60" - "100+100" - 1662-2162 mm, max. height 2281 mm.

DOOR LEAF FINISH

Plain surface painted, veneered, covered with CPL laminate with a thickness of 0.2 mm to 0.7 mm, HPL laminate with a thickness of 0.7 mm to 1 mm or wood-alike foil. Flat decorations made of decorative profiled mouldings, aluminium decors available.

GLAZINGS

Transparent glass pane with EI30 or EI60 fire resistance. Spacer painted, veneered or covered with foil in the colour matching the colour of the door leaf.

DOOR FRAMES

Door frame painted, veneered, covered with CPL 0.15 mm, CPL 0.2 mm laminate or foil matched to the colour of the door leaf.
Wooden pine fixed door frame - optionally with masking strips, quarter round.

Wooden adjustable door frame widening panels, angular architraves and a masking strip.
Fixed or adjustable metal EI30 PLUS or EI60 PLUS door frame

ACCESSORIES AND EQUIPMENT

Standard equipment of FR EI30 SR32:
- 3 object hinges, OBX type, by Eco Schulte
- PHA 2000 surface-mounted panic bar by Dormakaba (p. 205)
- drop seal

Standard equipment of the Halspan system EI30 Plus:
- 3 or 4 pivot hinges adjustable in 3 planes, EXACTA 495 Ø16, by OTLAV;
- single-leaf door - PHA 2000 surface-mounted panic bar by Dormakaba or PHA 2500 mortise lock panic bar by Dormakaba;
- double-leaf door - PHA 2000 surface-mounted panic bar by Dormakaba;
- drop seal

Standard equipment of the Halspan system EI60 Plus:
- 4 pivot hinges adjustable in 3 planes, EXACTA 495 Ø16, by OTLAV;
- single-leaf door - PHA 2000 surface-mounted panic bar by Dormakaba or PHA 2500 mortise lock panic bar by Dormakaba;
- double-leaf door - PHA 2000 surface-mounted panic bar by Dormakaba;
- drop seal.

Additional equipment:

FR EI30 SR32 door
- aluminium decors, reed switch, surface-mounted door closer
Halspan system EI30 Plus door
- aluminium decors, surface-mounted door closer
Halspan system EI60 Plus door
- aluminium decors, surface-mounted door closer

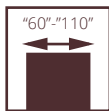

90 PLUS
WIDTH
FOR PUBLIC
UTILITY
BUILDINGS



POL-SKONE FIRE DOORS

FR EI30 SR 42

Pol-Skone system
without sidelights/toplights

NOTE! In order to meet the fire resistance conditions, use a door closer compliant with the requirements of the PN-EN 1154:1999/A1:2004/AC:2010 standard, door handles compliant with the requirements of the PN-EN 1906:2012 standard (min. class B with regard to fire resistance) and cylinders compliant with the requirements of the PN-EN 1303:2015 standard (class B with regard to fire resistance).



acoustic insulation

The doors are designed for use as interior entrance doors in residential buildings, collective dwellings, public utility and industrial buildings to close openings in interior walls, between staircases or corridors and rooms as determined by the PN-B-91000:1996 standard.

Door leaf in rebated system. The leaf structure consists of a rail and stile set made of coniferous wood, topped with HDF boards on both sides. The in-fill is a special Pol-Skone structure.

- Fire resistance EI_{2,30} (FR EI30 SR 42 DM)
- Fire resistance EI₃₀ (FR EI30 SR 42)
- Smoke control - class S_{a,r}, S₂₀₀ (FR EI30 SR 42 DM)
- Acoustic insulation capacity class D₁ - 40, D₂ - 35, class Rw=42 dB
- class 3 mechanical strength acc. to the PN-EN 1192:2001 standard
- National Technical Assessment ITB-KOT-2020/1370 issue 1
- National Certificate of Constancy of Performance no 020-UWB-1937/W

FR EI30 SR 42 DM door, fixed wooden door frame

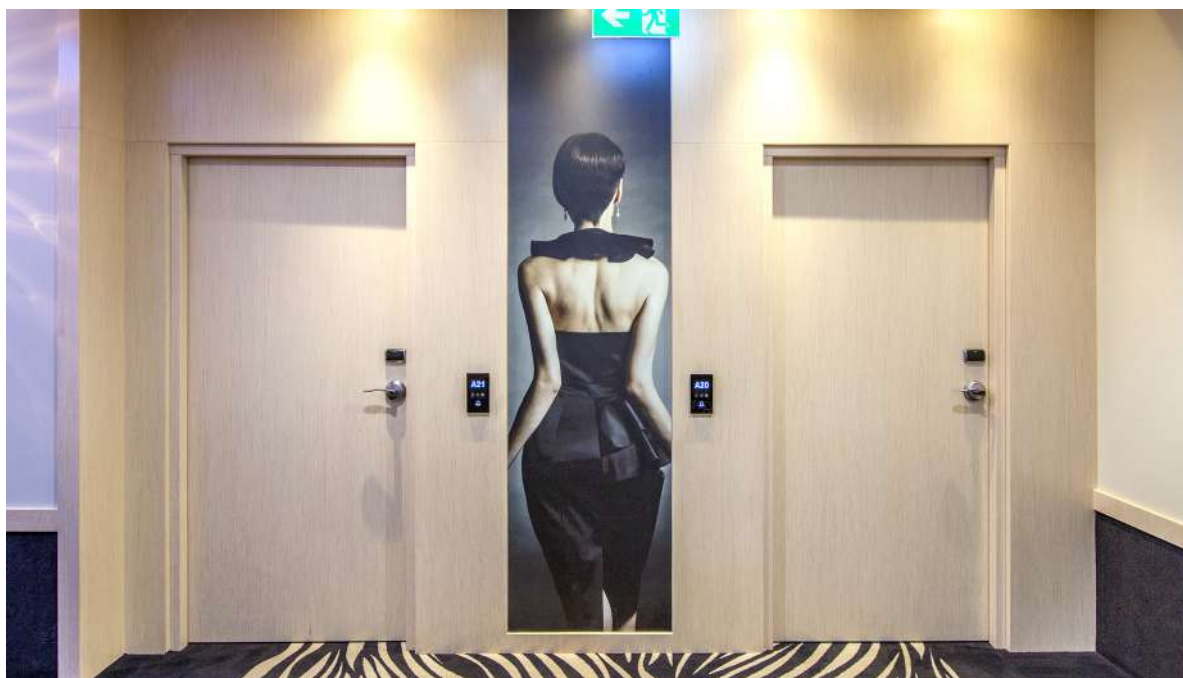

FR EI30 SR 42 DM fire door, fixed wooden door frame

FR EI30 SR42



VERSION	FR EI30 SR 42	FR EI30 SR 42 DM
LAMINATED CPL 0.2 mm		
LAMINATED CPL 0.5 mm		
UNI MAT PLUS		
LAMISTONE		
SILKSTONE		
SILKSTONE CPL 0.5 mm		
PAINTED – white		
PAINTED – grey, beige		
PAINTED - black, sage		
VENEERED GROUP A		
VENEERED GROUP B		
VENEERED GROUP C, D		

Exemplary hotel locks for FR EI30 SR 42 DM door:

- Signature or Classic series by VingCard,
- LE8P series + XS4 series handle with access control by Salto,
- LOB 5500 Adel series, LOB 8005 series, LOB 8002 series by ASSA ABLOY Opening Solutions Poland S.A.
- HDL MF 20 series, HDL MF 20 N series, HDL MF 65 series by Hartmann Tresore,
- Be-Tech 6536M-65A series, Be-Tech Guardian RFID Elegant series, Be-Tech G1 series by Guangdong BeTech Security Systems Co. LTD,
- Ilco 790 RFID series, Saflok RT series, Saflok Quantum RFID series by Dormakaba,
- Trillium series, Advance series by Onity,

extra charge added to the basic colour white (RAL 9003) acc. to RAL, NCS colour groups (p. 264)

Group I	Group II	Group III
Group IV	Group V	

extra charge CPL 0.5 mm, CPL 0.7 mm to door in CPL laminate coating (extra charge to standard door height)

CPL 0.5 mm ("60" - "90")	CPL 0.7 mm ("60" - "90")	CPL 0.5 mm ("90+" - "110")	CPL 0.7 mm ("90+" - "110")
-----------------------------	-----------------------------	-------------------------------	-------------------------------

THE FR EI30 SR 42 DM DOOR PROVIDE THE SMOKE CONTROL STANDARD OF $S_{a, S_{200}}$

DOOR DIMENSIONS

FR EI30 SR 42 DM door
Fixed wooden or adjustable door frame
1012x2075 mm
max. width "100" – 1112 mm, max. height 2175 mm

FR EI30 SR 42 door
Fixed wooden or adjustable door frame
1012x2075 mm
max. width "110" – 1212 mm, max. height 2275 mm

WIDTH FOR PUBLIC UTILITY BUILDINGS
90 Plus width - 1032 mm.
The 1032 mm door width provides a min. clearance of 900 mm for doors with the 90-degree opening angle.

WIDTH FOR PUBLIC UTILITY BUILDINGS
90 Plus width - 1032 mm.
The 1032 mm door width provides a min. clearance of 900 mm for doors with the 90-degree opening angle.

DOOR LEAF FINISH

Plain surface painted, veneered, covered with CPL laminate with a thickness of 0.2 mm to 0.7 mm, HPL laminate with a thickness of 0.7 mm to 1 mm or wood-alike foil. Flat decorations made of decorative profiled mouldings, aluminium decors available.

DOOR FRAMES

Door frame painted, veneered, covered with CPL 0.15 mm, CPL 0.2 mm laminate or foil matched to the colour of the door leaf.
Wooden pine fixed door frame - optionally with masking strips, quarter round.

Wooden adjustable door frame widening panels, angular architraves and a masking strip.

ACCESSORIES AND EQUIPMENT

Standard equipment of FR EI30 SR 42 DM:
- 2 object hinges, OBX type, by ECO SCHULTE
- mortise lock with cylinder
- 2 drop seals

Standard equipment of FR EI30 SR 42:
- object hinges, OBX type, by ECO SCHULTE
- leaf width "60"- "100" - 2 hinges
- leaf width "110" - 3 hinges
- height 2275 mm - 3 hinges
- mortise lock with cylinder;
- 2 drop seals

Standard equipment of FR EI30 SR 42 DM:
- decorations, stainless steel panels, aluminium decors
- EL560/EL561 electromotoric lock
- mortise coded (hotel) locks
- surface-mounted or hidden door closer
- additional mortise locks
- NC or NO electric doorstrikes
- reed switch
- electromagnetic lock
- electromagnetic holder
- panic bar with surface-mounted or mortise lock
- width "100" - 1112 mm **+10%**
- height of 2175 mm **+10%**

Standard equipment of FR EI30 SR 42:
- surface-mounted door closers - p. 203-207
- width "100" - 1112 mm **+10%**
- width "110" - 1212 mm **+20%**
- height of 2175 mm **+10%**
- height of 2275 mm **+20%**

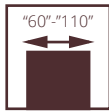

90 PLUS
WIDTH
FOR PUBLIC
UTILITY
BUILDINGS



EI30 PLUS door, fixed wooden door frame

POL-SKONE REBATED HALSPAN SYSTEM FIRE DOORS EI30 PLUS

NOTE! In order for the door to meet the fire resistance conditions, use a door closer compliant with the requirements of the PN-EN 1154:1999/A1:2004/AC:2010 standard, door handles compliant with the requirements of the PN-EN 1906:2012 standard (min. class B with regard to fire resistance) and cylinders compliant with the requirements of the PN-EN 1303:2015 standard (class B with regard to fire resistance).

Halspan system EI30 Plus rebated fire door with metal door frame optionally equipped with PHA 2000 or PHA 2500 panic hardware and EXACTA 495 Ø16 mm hinges meets the requirements of the PN-EN 1125:2009 standard in terms of release capability and can be used on escape routes and exits.

Door leaf in rebated system, wooden and metal (fixed or adjustable) door frame. The door leaf structure is a layered chipboard with a coniferous wood laminate topped with HDF boards on both sides. The rated door leaf thickness is 50 mm.

- Fire resistance EI₂30
- acoustic insulation capacity
- single-leaf door:
class D₁ – 30, D₂ – 25, class Rw=32 dB
- double-leaf door:
class D₁ – 25, D₂ – 25, class Rw=27 dB
- class 3 mechanical strength acc. to the PN-EN 1192:2001 standard
- Smoke control class S_a, S₂₀₀ (option)
- National Technical Assessment ITB-KOT-2018/0407 issue 2
- National Certificate of Constancy of Performance no 020-UWB-2695/W



EI30 PLUS single-leaf door, adjustable wooden door frame

EI30 PLUS



VERSION	flush	glazed	flush/flush	glazed/glazed	flush/glazed
---------	-------	--------	-------------	---------------	--------------

LAMINATED CPL 0.2 mm

UNI MAT PLUS

LAMISTONE

SILKSTONE

SILKSTONE CPL 0.5 mm

PAINTED – white

PAINTED – grey, beige

PAINTED - black, sage

VENEERED GROUP A

VENEERED GROUP B

VENEERED GROUP C, D

smoke control - extra charge: single-leaf door; double-leaf door

Doors in flush or flush / glazed version (wider leaf glazed, narrower leaf flush)

EXTRA CHARGES ADDED FOR NON-STANDARD DIMENSIONS OF FIRE DOORS

	standard width	non-standard width "100"	non-standard width "110"
standard height	-	extra charge 10%*	extra charge 20%*
non-standard height to 2200 mm		extra charge 10%*	extra charge 20%*
non-standard height to 2300 mm		extra charge 20%*	extra charge 30%*
non-standard height to 2400 mm		extra charge 30%*	extra charge 40%*
non-standard height to 2500 mm		extra charge 40%*	extra charge 50%*

*extra charge to door (door leaf+door frame)

Colours of metal door frames (p. 223)

extra charge added to the basic colour white (RAL 9003) acc. to RAL, NCS colour groups (p. 264)

Group I	Group II	Group III	Group IV	Group V
---------	----------	-----------	----------	---------

DOOR DIMENSIONS

Fixed wooden or adjustable door frame:

Rebated system:

Single-leaf door:

max. width: "110" – 1212 mm, max. height: 2500 mm

The 90 Plus version (it allows getting a min. clearance of 900 mm for the door leaf with a 90° opening angle)

1032x2075 mm

Double-leaf door:

max. width: "110+110" – 2352 mm, max. height: 2500 mm

Fixed metal door frame:

Rebated system:

Single-leaf door:

max. width "110" – 1204 mm, max. height 2271 mm

The 90 Plus version (it allows getting a min. clearance of 900 mm with the leaf opening angle of 90°) 1024x2071 mm

Double-leaf door:

max. width: "110+110" – 2342 mm, max. height: 2271 mm

DOOR LEAF FINISH

Plain surface painted, veneered, covered with CPL laminate with a thickness of 0.2 to 0.7 mm, HPL laminate with a thickness of 0.7 to 1.0 mm or wood-alike foil. Flat decorations made of decorative profiled mouldings available, aluminium decors.

GLAZINGS

Transparent glass pane with EI30 fire resistance. Pine spacer painted, veneered or covered with foil in the colour matching the colour of the door leaf. The available glazing includes a porthole with a Ø320 mm steel spacer (on the external side of the spacer).

DOOR FRAMES

Door frame painted, veneered, covered with CPL 0.15 mm, CPL 0.2 mm laminate or foil matched to the colour of the door leaf.

Fixed wooden pine door frame - optionally with masking strips, quarter round.

Wooden adjustable door frame with widening panels, angle architraves and a masking strip.

Fixed metal door frame made of steel sheet with a thickness of 1.5 mm, standard powder-coated in the colour of white (RAL 9016 and RAL 9003), grey (RAL 7047), brown (RAL 8014), beige (RAL 1001), graphite (RAL 7024), black (RAL 9005).

ACCESSORIES AND EQUIPMENT

Standard equipment:

- (door with wooden or metal door frame)
- 3 or 4 pivot hinges adjustable in 3 planes by OTLAV
- mortise lock with cylinder;
- drop seal

Additional equipment:

- aluminium decors - p. 201
- decorations - p. 186
- surface-mounted or hidden door closer, panic locks, panic bars, electric strikes, electromagnetic locks, reed switch, additional lock - p. 203-207
- The leaf can be milled for the installation of an (electronic) hotel lock subject to consultation with the Sales Department.

OPTIONAL GLAZING VERSIONS



W1S

W2S

W3S

W4S

DOOR LEAVES FOR METAL DOOR FRAME p. 177

METAL DOOR FRAME p. 178, 180

WIDTH FOR PUBLIC UTILITY BUILDINGS
the 90 plus door width allows getting a min. clearance of 900 mm for doors with the 90-degree opening angle.



POL-SKONE NON-REBATED HALSPAN SYSTEM FIRE DOORS EI30 PLUS

NOTE! In order for the door to meet the fire resistance conditions, use a door closer compliant with the requirements of the PN-EN 1154:1999/A1:2004/AC:2010 standard, door handles compliant with the requirements of the PN-EN 1906:2012 standard (class B with regard to fire resistance) and cylinders compliant with the requirements of the PN-EN 1303:2015 standard (class B with regard to fire resistance).

Door leaf in non-rebated system, wooden and metal (fixed or adjustable) door frame. The door leaf structure is a layered chipboard with a coniferous wood laminate topped with HDF boards on both sides. The rated door leaf thickness is 50 mm.

- Fire resistance EI₂30
- acoustic insulation capacity
- single-leaf door:
class D₁ – 30, D₂ – 25, class Rw=32 dB
- double-leaf door:
class D₁ – 25, D₂ – 25, class Rw=27 dB
- class 3 mechanical strength acc. to the PN-EN 1192:2001 standard
- Smoke control class S_a, S₂₀₀ (option)
- National Technical Assessment ITB-KOT-2018/0407 issue 2
- National Certificate of Constancy of Performance no 020-UWB-2695/W

EI30 PLUS door, fixed wooden door frame

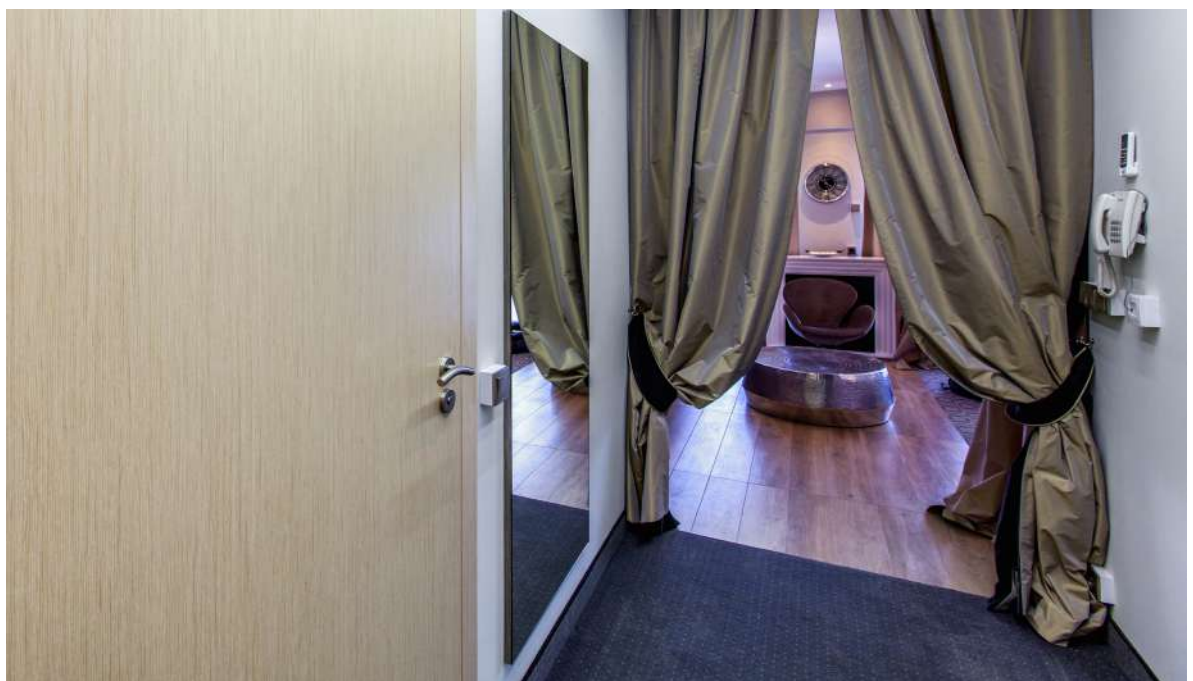

EI30 PLUS single-leaf door, fixed wooden door frame

EI30 PLUS

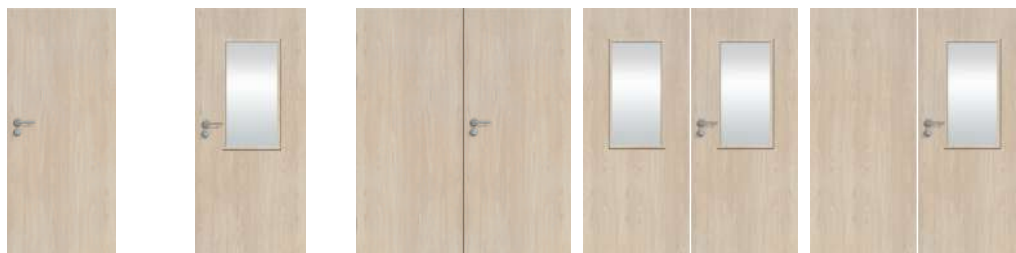

VERSION flush glazed flush/flush glazed/glazed flush/glazed

- LAMINATED CPL 0.2 mm
- UNI MAT PLUS
- LAMISTONE
- SILKSTONE
- SILKSTONE CPL 0.5 mm
- PAINTED – white
- PAINTED – grey, beige
- PAINTED – grey, beige
- VENEERED GROUP A
- VENEERED GROUP B
- VENEERED GROUP C, D

smoke control - extra charge: single-leaf door; double-leaf door

Doors in flush or flush / glazed version (wider leaf glazed, narrower leaf flush)

EXTRA CHARGES ADDED FOR NON-STANDARD DIMENSIONS OF FIRE DOORS

	standard width	non-standard width "100"	non-standard width "110"
standard height	-	extra charge 10%*	extra charge 20%*
non-standard height to 2200 mm	extra charge 10%*	extra charge 20%*	extra charge 30%*
non-standard height to 2300 mm	extra charge 20%*	extra charge 30%*	extra charge 40%*
non-standard height to 2400 mm	extra charge 30%*	extra charge 40%*	extra charge 50%*
non-standard height to 2500 mm	extra charge 40%*	extra charge 50%*	extra charge 60%*

*extra charge to door (door leaf+door frame)

Colours of metal door frames (p. 223)

extra charge added to the basic colour, white (RAL 9003) acc. to RAL, NCS colour groups (p. 264)

Group I	Group II	Group III	Group IV	Group V
---------	----------	-----------	----------	---------



OPTIONAL GLAZING VERSIONS

W1S W2S W3S W4S

DOOR LEAVES FOR METAL DOOR FRAME p. 177 METAL DOOR FRAME p. 179, 181

DOOR DIMENSIONS

Fixed wooden or adjustable door frame:

Non-rebated system
 Single-leaf door:
 max. width "110" – 1212 mm, max. height 2500 mm
The 90 Plus version (it allows getting a min. clearance of 900 mm for the door leaf opening angle of 90°) 1072x2075 mm
 Double-leaf door:
 max. width: "110+110" – 2330 mm, max. height: 2500 mm

Fixed metal door frame:

Non-rebated system
 Single-leaf door:
 max. width "110" – 1224 mm, max. height 2281 mm
The 90 Plus version (it allows getting a min. clearance of 900 mm when the door leaf opening angle is 90°) 1084x2081 mm
 Double-leaf door:
 max. width: "110+110" – 2340 mm, max. height: 2281 mm

Metal adjustable door frame:

Non-rebated system
 Single-leaf door:
 max. width "110" – 1224 mm, max. height 2281 mm
The 90 Plus version (it allows getting a min. clearance of 900 mm when the door leaf opening angle is 90°) 1084x2081 mm
 Double-leaf door:
 max. width: "110+110" – 2340 mm, max. height: 2281 mm
 Doors of non-standard width and height are available upon consultation with the POL-SKONE sales department.

WIDTH FOR PUBLIC UTILITY BUILDINGS
 the 90 plus door width allows getting a min. clearance of 900 mm for doors with the 90-degree opening angle.

DOOR LEAF FINISH

Plain surface painted, veneered, covered with CPL laminate with a thickness of 0.2 to 0.7 mm, HPL laminate with a thickness of 0.7 to 1.0 mm or wood-alike foil. Flat decorations made of decorative profiled mouldings available, aluminium decors.

GLAZINGS

Transparent glass pane with EI30 fire resistance. Pine spacer painted, veneered or covered with foil in the colour matching the colour of the door leaf. The available glazing includes a porthole with a Ø320 mm steel spacer (on the external side of the spacer).

DOOR FRAMES

Door frame painted, veneered, covered with CPL 0.15 mm, CPL 0.2 mm laminate or foil matched to the colour of the door leaf.
Fixed wooden pine door frame - optionally with masking strips, quarter round.
Wooden adjustable door frame with widening panels, angle architraves and a masking strip.
Fixed metal door frame made of steel sheet with a thickness of 1.5 mm, standard powder-coated in the colour of white (RAL 9016 and RAL 9003), grey (RAL 7047), brown (RAL 8014), beige (RAL 1001), graphite (RAL 7024), black (RAL 9005).

Adjustable metal door frame made of sheet steel of a thickness of 1.5 mm, standard powder-coated in the colour of white (RAL 9016 and RAL 9003), grey (RAL 7047), brown (RAL 8014), beige (RAL 1001), graphite (RAL 7024), black (RAL 9005).

Door frames painted in non-standard colours from RAL or NCS palettes are available upon consultation with the Sales Department.
 The door frame consists of a major part and an angular architrave inserted into the major part.

ACCESSORIES AND EQUIPMENT

Standard equipment:
 (door with wooden or metal door frame)
 - 3 object hinges, OBX type, by ECO SCHULTE or hidden TECTUS hinges by Simonswerk (option available at an extra charge)
 - mortise lock with cylinder;
 - drop seal

Additional equipment:
 - aluminium decors - p. 201
 - decorations - p. 186
 - surface-mounted or hidden door closer, panic locks, panic bars, electric strikes, electromagnetic locks, reed switch, additional lock - p. 203-207
 - panoramic viewer - stainless steel; anthracite, black matt
 The leaf can be milled for the installation of an (electronic) hotel lock subject to consultation with the Sales Department.

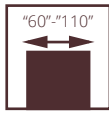

90 PLUS
WIDTH
FOR PUBLIC
UTILITY
BUILDINGS



EI60 PLUS door, fixed wooden door frame

POL-SKONE REBATED HALSPAN SYSTEM FIRE DOORS EI60 PLUS

NOTE! In order for the door to meet the fire resistance conditions, use a door closer compliant with the requirements of the PN-EN 1154:1999/A1:2004/AC:2010 standard, door handles compliant with the requirements of the PN-EN 1906:2012 standard (min. class B with regard to fire resistance) and cylinders compliant with the requirements of the PN-EN 1303:2015 standard (class B with regard to fire resistance).

Halspan system EI60 Plus rebated fire door with metal door frame optionally equipped with PHA 2000 or PHA 2500 panic hardware and EXACTA 495 \varnothing 16 mm hinges meets the requirements of the PN-EN 1125:2009 standard in terms of release capability and can be used on escape routes and exits.

Door leaf in rebated system. The door leaf structure is a layered chipboard with a coniferous wood laminate topped with HDF boards on both sides. The rated door leaf thickness is 60 mm.

- Fire resistance EI₂60
- acoustic insulation capacity
- single-leaf door: class D₁ - 30, D₂ - 25, class Rw=32 dB
- double-leaf door: class D₁ - 25, D₂ - 25, class Rw=32 dB
- class 3 mechanical strength acc. to the PN-EN 1192:2001 standard
- Smoke control class S_a, S₂₀₀ (option)
- National Technical Assessment ITB-KOT-2018/0407 issue 2
- National Certificate of Constancy of Performance no 020-UWB-2695/W



EI60 PLUS door, adjustable wooden door frame

EI60 PLUS



VERSION flush glazed flush/flush glazed/glazed flush/glazed

LAMINATED CPL 0.2 mm
UNI MAT PLUS
LAMISTONE
SILKSTONE
SILKSTONE CPL 0.5 mm
PAINTED – white
PAINTED – grey, beige
PAINTED - black, sage
VENEERED GROUP A
VENEERED GROUP B
VENEERED GROUP C, D

smoke control - extra charge: single-leaf door; double-leaf door

Doors in flush or flush / glazed version (wider leaf glazed, narrower leaf flush)

EXTRA CHARGES ADDED FOR NON-STANDARD DIMENSIONS OF FIRE DOORS

	standard width	non-standard width "100"	non-standard width "110"
standard height	-	extra charge 10%*	extra charge 20%*
non-standard height to 2200 mm	extra charge 10%*	extra charge 20%*	extra charge 30%*
non-standard height to 2300 mm	extra charge 20%*	extra charge 30%*	extra charge 40%*
non-standard height to 2400 mm	extra charge 30%*	extra charge 40%*	extra charge 50%*
non-standard height to 2500 mm	extra charge 40%*	extra charge 50%*	extra charge 60%*

*extra charge to door (door leaf+door frame)

Colours of metal door frames (p. 223)

OPTIONAL GLAZING VERSIONS



W1S

W3S

extra charge added to the basic colour white (RAL 9003) acc. to RAL, NCS colour groups (p. 264)

Group I	Group II	Group III	Group IV	Group V
---------	----------	-----------	----------	---------

DOOR LEAVES FOR METAL DOOR FRAME p. 177

METAL DOOR FRAME p. 178, 180

DOOR DIMENSIONS

Fixed wooden or adjustable door frame:

Rebated system:

Single-leaf door:

max. width "110" – 1212 mm, max. height 2500 mm

The 90 Plus version (it allows getting a min. clearance of 900 mm for the door leaf opening angle of 90°)

Double-leaf flush door:

max. width: "110+110" – 2352 mm, max. height: 2500 mm

Double-leaf glazed door:

max. width: "100+100" – 2152 mm, max. height: 2350 mm

Fixed metal door frame:

Rebated system:

Single-leaf door:

max. width "110" – 1204 mm, max. height 2271 mm

The 90 Plus version (it allows getting a min. clearance of 900 mm for the door leaf opening angle of 90°)

Double-leaf flush door:

max. width: "110+110" – 2342 mm, max. height: 2271 mm

Double-leaf glazed door:

max. width: "100+100" – 2142 mm, max. height: 2271 mm

Metal adjustable door frame:

Rebated system:

Single-leaf door:

max. width "110" – 1224 mm, max. height 2281 mm

The 90 Plus version (it allows getting a min. clearance of 900 mm for the door leaf opening angle of 90°)

Double-leaf flush door:

max. width: "110+110" – 2362 mm, max. height: 2281 mm

Double-leaf glazed door:

max. width: "100+100" – 2162 mm, max. height: 2281 mm

WIDTH FOR PUBLIC UTILITY BUILDINGS
the 90 plus door width allows getting a min. clearance of 900 mm for doors with the 90-degree opening angle.

DOOR LEAF FINISH

Plain surface painted, veneered, covered with CPL laminate with a thickness of 0.2 to 0.7 mm, HPL laminate with a thickness of 0.7 to 1.0 mm or wood-alike foil. Flat decorations made of decorative profiled mouldings available, aluminium decors.

GLAZINGS

Transparent glass pane with EI60 fire resistance. Pine spacer painted, veneered or covered with foil matching the colour of the door leaf. The available glazing includes a porthole with a Ø320 mm steel spacer (on the external side of the spacer).

DOOR FRAMES

Door frame painted, veneered, covered with CPL 0.15 mm, CPL 0.2 mm laminate or foil matched to the colour of the door leaf.

Fixed wooden pine door frame - optionally with masking strips, quarter round.

Wooden adjustable door frame with widening panels, angular architraves and a masking strip.

Fixed metal door frame made of steel sheet with a thickness of 1.5 mm, standard powder-coated in the colour of white (RAL 9016 and RAL 9003), grey (RAL 7047), brown (RAL 8014), beige (RAL 1001), graphite (RAL 7024), black (RAL 9005).

Adjustable metal door frame made of steel sheet of a thickness of 1.5 mm, standard powder-coated in the colour of white (RAL 9016 and RAL 9003), grey (RAL 7047), brown (RAL 8014), beige (RAL 1001), graphite (RAL 7024), black (RAL 9005).

Door frames painted in non-standard colours from RAL or NCS palettes are available upon consultation with the Sales Department.

The door frame consists of a major part and an angular architrave inserted into the major part.

ACCESSORIES AND EQUIPMENT

Standard equipment:

- (door with wooden or metal door frame)
- 4 pivot hinges adjustable in 3 planes by OTLAV
- mortise lock with cylinder
- drop seal

Additional equipment:

- aluminium decors - p. 201
- decorations - p. 186
- surface-mounted or hidden door closer, panic locks, panic bars, electric strikes, electromagnetic locks, reed switch, additional lock - p. 203-207

The leaf can be milled for the installation of an (electronic) hotel lock subject to consultation with the Sales Department.

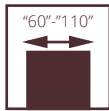

EI60 PLUS door, fixed wooden door frame

POL-SKONE NON-REBATED HALSPAN SYSTEM FIRE DOORS EI60 PLUS

NOTE! In order for the door to meet the fire resistance conditions, use a door closer compliant with the requirements of the PN-EN 1154:1999/A1:2004/AC:2010 standard, door handles compliant with the requirements of the PN-EN 1906:2012 standard (min. class B with regard to fire resistance) and cylinders compliant with the requirements of the PN-EN 1303:2015 standard (class B with regard to fire resistance).

Door leaf in non-rebated system. The door leaf structure is a layered chipboard with a coniferous wood laminate topped with HDF boards on both sides. The rated door leaf thickness is 60 mm.

- Fire resistance EI₂60
- acoustic insulation capacity
- single-leaf door: class D₁ – 30, D₂ – 25, class Rw=32 dB
- double-leaf door: class D₁ – 25, D₂ – 25, class Rw=32 dB
- class 3 mechanical strength acc. to the PN-EN 1192:2001 standard
- Smoke control class S_a, S₂₀₀ (option)
- National Technical Assessment ITB-KOT-2018/0407 issue 2
- National Certificate of Constancy of Performance no 020-UWB-2695/W



EI60 PLUS door, adjustable wooden door frame

EI60 PLUS



VERSION flush glazed flush/flush glazed/glazed flush/glazed

LAMINATED CPL 0.2 mm

UNI MAT PLUS

LAMISTONE

SILKSTONE

SILKSTONE CPL 0.5 mm

PAINTED – white

PAINTED – grey, beige

PAINTED - black, sage

VENEERED GROUP A

VENEERED GROUP B

VENEERED GROUP C, D

smoke control - extra charge: single-leaf door; double-leaf door

Doors in flush or flush / glazed version (wider leaf glazed, narrower leaf flush)

EXTRA CHARGES ADDED FOR NON-STANDARD DIMENSIONS OF FIRE DOORS

	standard width	non-standard width "100"	non-standard width "110"
standard height	-	extra charge 10%*	extra charge 20%*
non-standard height to 2200 mm	extra charge 10%*	extra charge 20%*	extra charge 30%*
non-standard height to 2300 mm	extra charge 20%*	extra charge 30%*	extra charge 40%*
non-standard height to 2400 mm	extra charge 30%*	extra charge 40%*	extra charge 50%*
non-standard height to 2500 mm	extra charge 40%*	extra charge 50%*	extra charge 60%*

*extra charge to door (door leaf+door frame)

Colours of metal door frames (p. 223)

extra charge added to the basic colour white (RAL 9003) acc. to RAL, NCS colour groups (p. 264)

Group I	Group II	Group III	Group IV	Group V
---------	----------	-----------	----------	---------

OPTIONAL GLAZING VERSIONS



W1S

W3S

DOOR LEAVES FOR METAL DOOR FRAME p. 177

METAL DOOR FRAME p. 179, 181

DOOR DIMENSIONS

Fixed wooden or adjustable door frame:

Non-rebated system

Single-leaf door:

max. width "110" – 1212 mm, max. height 2500 mm

The 90 Plus version (it allows getting a min. clearance of 900 mm for the door leaf opening angle of 90°)

1072x2075 mm

Double-leaf flush door:

max. width: "110+110" – 2330 mm, max. height: 2500 mm

Double-leaf glazed door:

max. width: "100+100" – 2130 mm, max. height: 2350 mm

Fixed metal door frame:

Non-rebated system

Single-leaf door:

max. width "110" – 1224 mm, max. height 2281 mm

The 90 Plus version (it allows getting a min. clearance of 900 mm when the door leaf opening angle is 90°)

1084x2081 mm

Double-leaf flush door:

max. width: "110+110" – 2340 mm, max. height: 2281 mm

Double-leaf glazed door:

max. width: "100+100" – 2140 mm, max. height: 2281 mm

Metal adjustable door frame:

Non-rebated system

Single-leaf door:

max. width "110" – 1224 mm, max. height 2281 mm

The 90 Plus version (it allows getting a min. clearance of 900 mm when the door leaf opening angle is 90°)

1084x2081 mm

Double-leaf flush door:

max. width: "110+110" – 2340 mm, max. height: 2281 mm

Double-leaf glazed door:

max. width: "100+100" – 2140 mm, max. height: 2281 mm

Doors of non-standard width and height are available upon consultation with the POL-SKONE sales department.

WIDTH FOR PUBLIC UTILITY BUILDINGS
the 90 plus door width allows getting a min. clearance of 900 mm for doors with the 90-degree opening angle.

DOOR LEAF FINISH

Plain surface painted, veneered, covered with CPL laminate with a thickness of 0.2 to 0.7 mm, HPL laminate with a thickness of 0.7 to 1.0 mm or wood-alike foil. Flat decorations made of decorative profiled mouldings available, aluminium decors.

GLAZINGS

Transparent glass pane with EI60 fire resistance. Pine spacer painted, veneered or covered with foil matching the colour of the door leaf. The available glazing includes a porthole with a Ø320 mm steel spacer (on the external side of the spacer).

DOOR FRAMES

Door frame painted, veneered, covered with CPL 0.15 mm, CPL 0.2 mm laminate or foil matched to the colour of the door leaf.

Fixed wooden pine door frame - optionally with masking strips, quarter round.

Wooden adjustable door frame with widening panels, angular architraves and a masking strip.

Fixed metal door frame made of steel sheet with a thickness of 1.5 mm, standard powder-coated in the colour of white (RAL 9016 and RAL 9003), grey (RAL 7047), brown (RAL 8014), beige (RAL 1001), graphite (RAL 7024), black (RAL 9005).

Adjustable metal door frame made of steel sheet of a thickness of 1.5 mm, standard powder-coated in the colour of white (RAL 9016 and RAL 9003), grey (RAL 7047), brown (RAL 8014), beige (RAL 1001), graphite (RAL 7024), black (RAL 9005).

Door frames painted in non-standard colours from RAL or NCS palettes are available upon consultation with the Sales Department.

The door frame consists of a major part and an angular architrave inserted into the major part.

ACCESSORIES AND EQUIPMENT

Standard equipment:

- (door with wooden or metal door frame)
- 3 object hinges, OBX type, by ECO SCHULTE or hidden TECTUS hinges by Simonswerk (option available at an extra charge)
- main lock with cylinder
- drop seal

Additional equipment:

- aluminium decors - p. 201
 - decorations - p. 186
 - surface-mounted or hidden door closer, panic locks, panic bars, electric strikes, electromagnetic locks, reed switch, additional lock - p. 203-207
- The leaf can be milled for the installation of an (electronic) hotel lock subject to consultation with the Sales Department.

ADJUSTABLE DOOR FRAMES FOR ENTRANCE DOORS

FOR B-30, C-30, CERBER PLUS, CERBER PLUS RC2, RC3 BURGLAR-PROOF DOORS

EXTRA CHARGE ADDED FOR THE ADJUSTMENT SET FOR THE B-30, C-30, RC3, CERBER PLUS (WITH FLAT MOULDINGS- 60 mm), CERBER PLUS RC2 BURGLAR-PROOF DOORS (DOOR FRAMES ARE MILLED ON ONE SIDE TO FACILITATE THE INSTALLATION OF PANELS AND ARCHITRAVES)

CERBER PLUS, CERBER PLUS RC2	B-30, C-30, RC3	ECO TOP	UNI MAT PLUS	for the laminated type	PAINTED white	PAINTED grey, beige	BLACK RAL 9005 SAGE NCS S 4010-G50Y	VENEERED		
				HIGH TOP				GROUP A	GROUP B	GROUP C, D
symbol	range of adjustment	symbol of door frame	degree of adjustment	LAMISTONE CPL						
				SILKSTONE						
ZC 1	92-112	ZB1	100-120							
ZC 2	112-136	ZB2	120-144							
ZC 3	136-180	ZB3	144-188							
ZC 4	180-202	ZB4	188-210							
ZC 5	202-246	ZB5	210-254							
ZC 6	246-268	ZB6	254-276							
ZC 7	268-312	ZB7	276-320							
ZC 8	312-334	ZB8	320-342							
ZC 9	334-378	ZB9	342-386							
ZC 10	378-402	ZB10	386-410							
		ZB11	410-429							
		ZB12	429-476							
		ZB13	476-495							
		ZB14	495-542							
		ZB15	542-561							
		ZB16	561-608							

for door frames with non-standard dimensions (each dimension module available at an extra charge) **+10%**
architraves interconnected at the 90° angle

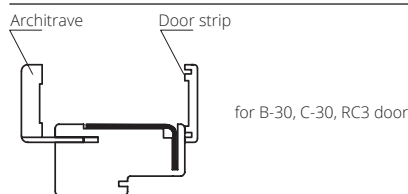

for B-30, C-30, RC3 door

symbol	adjustment range	COMPLETE SET
ZB1	100-120	Door frame 100 mm, architrave 32 mm
ZB2	120-144	Door frame 100 mm, architrave 52 mm

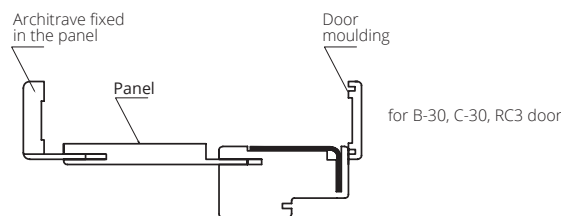

for B-30, C-30, RC3 door

symbol	adjustment range	COMPLETE SET
ZB3	144-188	Door frame 100 mm, moulding, architrave 32 mm, panel 76 mm
ZB4	188-210	Door frame 100 mm, moulding, architrave 52 mm, panel 76 mm
ZB5	210-254	Door frame 100 mm, moulding, architrave 32 mm, panel 142 mm
ZB6	254-276	Door frame 100 mm, moulding, architrave 52 mm, panel 142 mm
ZB7	276-320	Door frame 100 mm, moulding, architrave 32 mm, panel 208 mm
ZB8	320-342	Door frame 100 mm, moulding, architrave 52 mm, panel 208 mm
ZB9	342-386	Door frame 100 mm, moulding, architrave 32 mm, panel 274 mm
ZB10	386-410	Door frame 100 mm, moulding, architrave 52 mm, panel 274 mm

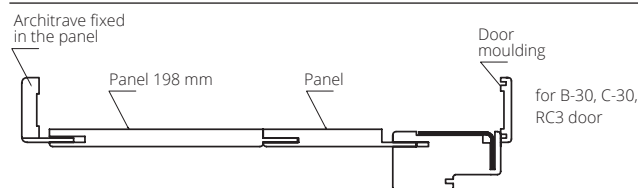

for B-30, C-30, RC3 door

symbol	adjustment range	COMPLETE SET
ZB11	410-429	Door frame 100 mm, moulding, architrave 32 mm, panel 142+198 mm
ZB12	429-476	Door frame 100 mm, moulding, architrave 52 mm, panel 142+198 mm
ZB13	476-495	Door frame 100 mm, moulding, architrave 32 mm, panel 208+198 mm
ZB14	495-542	Door frame 100 mm, moulding, architrave 52 mm, panel 208+198 mm
ZB15	542-561	Door frame 100 mm, moulding, architrave 32 mm, panel 274+198 mm
ZB16	561-608	Door frame 100 mm, moulding, architrave 52 mm, panel 274+198 mm

for CERBER PLUS, CERBER PLUS RC2 door

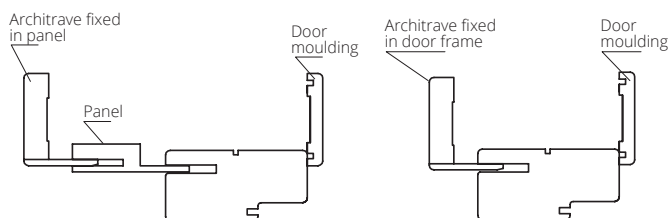

symbol	range of adjustment	COMPLETE SET
ZC 1	92-112	Door frame 92 mm, door moulding, architrave 32 mm
ZC 2	112-136	Door frame 92 mm, door moulding, architrave 52 mm
ZC 3	136-180	Door frame 92 mm, moulding, architrave 32 mm, panel 76 mm
ZC 4	180-202	Door frame 92 mm, moulding, architrave 52 mm, panel 76 mm
ZC 5	202-246	Door frame 92 mm, moulding, architrave 32 mm, panel 142 mm
ZC 6	246-268	Door frame 92 mm, moulding, architrave 52 mm, panel 142 mm
ZC 7	268-312	Door frame 92 mm, moulding, architrave 32 mm, panel 208 mm
ZC 8	312-334	Door frame 92 mm, moulding, architrave 52 mm, panel 208 mm
ZC 9	334-378	Door frame 92 mm, moulding, architrave 32 mm, panel 274 mm
ZC 10	378-402	Door frame 92 mm, moulding, architrave 52 mm, panel 274 mm

EXTRA CHARGE FOR THE ADJUSTMENT SET FOR FIRE DOOR WITH FIXED DOOR FRAME

for the single-leaf door

door frame symbol	adjustment range (mm)	door frame symbol*	adjustment range (mm)	ECO TOP	UNI MAT PLUS	LAMINATED HIGH TOP LAMISTONE SILKSTONE	PAINTED white	PAINTED grey, beige	BLACK RAL 9005 SAGE NCS S 4010-G50Y	VENEERED GROUP A	VENEERED GROUP B	VENEERED GROUP C
ZB1	100-120	ZA1	120-140									
ZB2	120-144	ZA2	140-164									
ZB3	144-188	ZA3	164-208									
ZB4	188-210	ZA4	208-230									
ZB5	210-254	ZA5	230-274									
ZB6	254-276	ZA6	274-296									
ZB7	276-320	ZA7	296-340									
ZB8	320-342	ZA8	340-362									
ZB9	342-386	ZA9	362-406									
ZB10	386-410	ZA10	406-430									
ZB11	410-429	ZA11	430-449									
ZB12	429-476	ZA12	449-496									
ZB13	476-495	ZA13	496-515									
ZB14	495-542	ZA14	515-562									
ZB15	542-561	ZA15	562-581									
ZB16	561-608	ZA16	581-628									

extra charge for door frames with non-standard dimensions (extra charge for each dimensional module) **+10%** double-leaf door **+50%** * applicable to the EI60 PLUS door

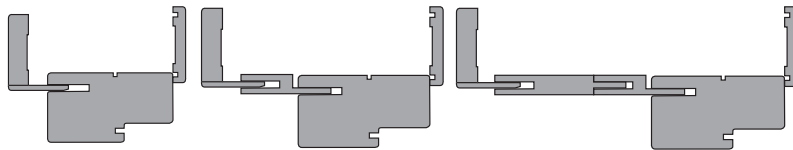

EXTRA CHARGE FOR A DOUBLE-SIDED FOR EI30 POL-SKONE SYSTEM, SR 37 dB, SR 42 dB FIRE DOOR

for the single-leaf door

door frame symbol	adjustment range (mm)	ECO TOP	UNI MAT PLUS	LAMINATED HIGH TOP LAMISTONE SILKSTONE	PAINTED white	PAINTED grey, beige	BLACK RAL 9005 SAGE NCS S 4010-G50	VENEERED GROUP A	VENEERED GROUP B	VENEERED GROUP C, D
ZF1	100-108									
ZF2	108-132									
ZF3	132-176									
ZF4	176-198									
ZF5	198-242									
ZF6	242-264									
ZF7	264-308									
ZF8	308-330									
ZF9	330-374									
ZF10	374-398									
ZF11	398-417									
ZF12	417-464									
ZF13	464-483									
ZF14	483-530									
ZF15	530-548									
ZF16	548-593									

double-leaf door **+50%** for door frames with non-standard dimensions (each dimension module available at an extra charge) **+10%**

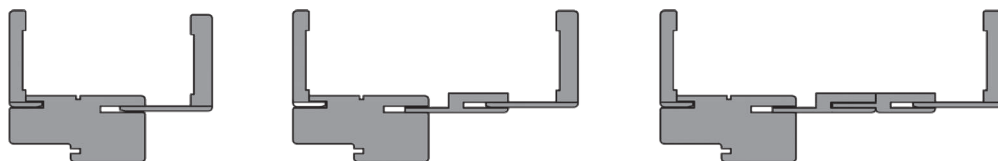

EXTRA CHARGES ADDED FOR NON-STANDARD DIMENSIONS OF ADJUSTMENT SETS

standard height	standard width	non-standard width "100"	non-standard width "110"
non-standard height to 2200 mm	-	extra charge 10%*	extra charge 20%*
non-standard height to 2300 mm	extra charge 10%*	extra charge 20%*	extra charge 30%*
non-standard height to 2400 mm	extra charge 20%*	extra charge 30%*	extra charge 40%*
non-standard height to 2500 mm	extra charge 30%*	extra charge 40%*	extra charge 50%*
	extra charge 40%*	extra charge 50%*	extra charge 60%*

EXTRA CHARGES FOR CHANGING THE VERTICAL ELEMENT FROM STANDARD TO ARCHITRAVE WITH A WIDTH FROM 150 MM TO 210 MM (FOR DOOR B-30, C-30, RC3, CERBER PLUS, EI30 PLUS, EI60 PLUS, EI30)

ECO TOP	HIGH TOP LAMISTONE CPL SILKSTONE LAMINATE CPL 0.2	PAINTED WHITE	PAINTED GREY, BEIGE	BLACK SAGE	VENEERED GROUP A	VENEERED GROUP B	VENEERED GROUP C
---------	---	---------------	---------------------	------------	------------------	------------------	------------------

architrave 210 mm vertical element
2115 mm + tongue 12 mm
architrave 210 mm vertical element
2115 mm + tongue 32 mm
architrave 210 mm vertical element
2115 mm + tongue 52 mm

TECHNICAL DIMENSIONS

WOODEN DOOR FRAMES

ZF: for FR EI30 door

ZB: for EI30 PLUS, B-30, C-30, RC3, SR 37 dB door

ZA: for EI60 PLUS door

symbol	range of adjustment	symbol	range of adjustment	complete set	1	symbol	range of adjustment	complete set
ZF1	100-108	ZB1	100-120	door frame 100 mm, moulding, architrave 32 mm	2	ZA1	120-140	door frame 120 mm, moulding, architrave 32 mm
ZF2	108-132	ZB2	120-144	door frame 100 mm, moulding, architrave 52 mm		ZA2	140-164	door frame 120 mm, moulding, architrave 52 mm
symbol	range of adjustment	symbol	range of adjustment	complete set	2	symbol	range of adjustment	complete set
ZF3	132-176	ZB3	144-188	door frame 100 mm, moulding, architrave 32 mm, board 76 mm	3	ZA3	164-208	door frame 120 mm, moulding, architrave 32 mm, board 76 mm
ZF4	176-198	ZB4	188-210	door frame 100 mm, moulding, architrave 52 mm, board 76 mm		ZA4	208-230	door frame 120 mm, moulding, architrave 52 mm, board 76 mm
ZF5	198-242	ZB5	210-254	door frame 100 mm, moulding, architrave 32 mm, board 142 mm	ZA5	230-274	door frame 120 mm, moulding, architrave 32 mm, board 142 mm	
ZF6	242-264	ZB6	254-276	door frame 100 mm, moulding, architrave 52 mm, board 142 mm	ZA6	274-296	door frame 120 mm, moulding, architrave 52 mm, board 142 mm	
ZF7	264-308	ZB7	276-320	door frame 100 mm, moulding, architrave 32 mm, board 208 mm	ZA7	296-340	door frame 120 mm, moulding, architrave 32 mm, board 208 mm	
ZF8	308-330	ZB8	320-342	door frame 100 mm, moulding, architrave 52 mm, board 208 mm	ZA8	340-362	door frame 120 mm, moulding, architrave 52 mm, board 208 mm	
ZF9	330-374	ZB9	342-386	door frame 100 mm, moulding, architrave 32 mm, board 274 mm	ZA9	362-406	door frame 120 mm, moulding, architrave 32 mm, board 274 mm	
ZF10	374-398	ZB10	386-410	door frame 100 mm, moulding, architrave 52 mm, board 274 mm	ZA10	406-430	door frame 120 mm, moulding, architrave 52 mm, board 274 mm	
symbol	range of adjustment	symbol	range of adjustment	complete set	3	symbol	range of adjustment	complete set
ZF11	398-417	ZB11	410-429	door frame 100 mm, moulding, architrave 32 mm, board 142+198 mm	1	ZA11	430-449	door frame 120 mm, moulding, architrave 32 mm, board 142+198 mm
ZF12	417-464	ZB12	429-476	door frame 100 mm, moulding, architrave 52 mm, board 142+198 mm		ZA12	449-496	door frame 120 mm, moulding, architrave 52 mm, board 142+198 mm
ZF13	464-483	ZB13	476-495	door frame 100 mm, moulding, architrave 32 mm, board 208+198 mm	ZA13	496-515	door frame 120 mm, moulding, architrave 32 mm, board 208+198 mm	
ZF14	483-530	ZB14	495-542	door frame 100 mm, moulding, architrave 52 mm, board 208+198 mm	ZA14	515-562	door frame 120 mm, moulding, architrave 52 mm, board 208+198 mm	
ZF15	530-548	ZB15	542-560	door frame 100 mm, moulding, architrave 32 mm, board 274+198 mm	ZA15	562-580	door frame 120 mm, moulding, architrave 32 mm, board 274+198 mm	
ZF16	548-593	ZB16	560-605	door frame 100 mm, moulding, architrave 52 mm, board 274+198 mm	ZA16	580-625	door frame 120 mm, moulding, architrave 52 mm, board 274+198 mm	

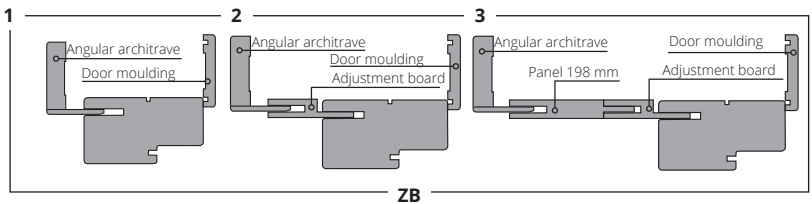
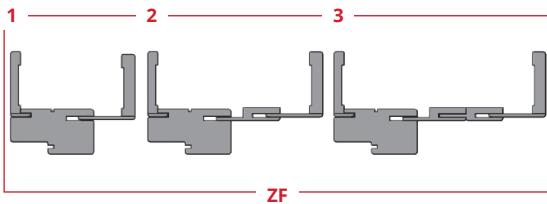

For CERBER PLUS, CERBER PLUS 37 dB, GAMMA door

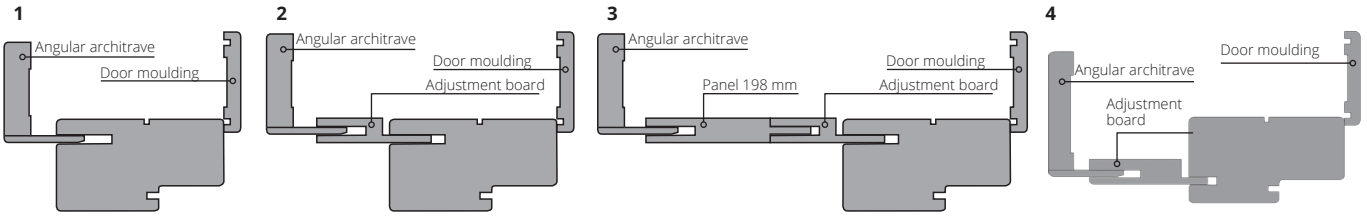

symbol	range of adjustment	complete set	1	symbol	range of adjustment	complete set	2	symbol	range of adjustment	complete set	3
ZC1, ZG1	92-112	door frame 92 mm, moulding, architrave 32 mm	1	ZC3, ZG3	136-180	door frame 92 mm, moulding, architrave 32 mm, board 76 mm	2	ZC11, ZG11	402-421	door frame 92 mm, moulding, architrave 32 mm, board 142+198 mm	3
ZC2, ZG2	112-136	door frame 92 mm, moulding, architrave 52 mm		ZC4, ZG4	180-202	door frame 92 mm, moulding, architrave 52 mm, board 76 mm		ZC12, ZG12	421-468	door frame 92 mm, moulding, architrave 52 mm, board 142+198 mm	
				ZC5, ZG5	202-246	door frame 92 mm, moulding, architrave 32 mm, board 142 mm		ZC13, ZG13	468-487	door frame 92 mm, moulding, architrave 32 mm, board 208+198 mm	
				ZC6, ZG6	246-268	door frame 92 mm, moulding, architrave 52 mm, board 142 mm		ZC14, ZG14	487-534	door frame 92 mm, moulding, architrave 52 mm, board 208+198 mm	
				ZC7, ZG7	268-312	door frame 92 mm, moulding, architrave 32 mm, board 208 mm		ZC15, ZG15	534-553	door frame 92 mm, moulding, architrave 32 mm, board 274+198 mm	
				ZC8, ZG8	312-334	door frame 92 mm, moulding, architrave 52 mm, board 208 mm		ZC16, ZG16	553-600	door frame 92 mm, moulding, architrave 52 mm, board 274+198 mm	
				ZC9, ZG9	334-378	door frame 92 mm, moulding, architrave 32 mm, board 274 mm					
				ZC10, ZG10	378-402	door frame 92 mm, moulding, architrave 52 mm, board 274 mm					

A customised casing is available subject to consultation with the Sales Department.

DOOR FRAMES FOR TYPE A, TYPE B, TYPE A DUO, TYPE B DUO SOUNDPROOF DOORS

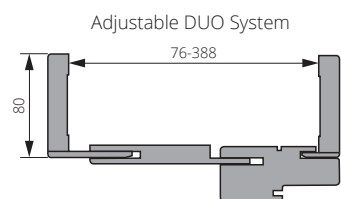
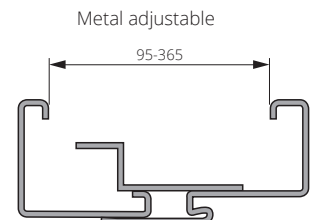
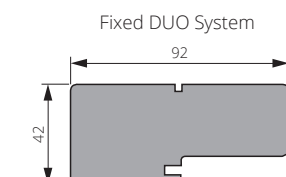
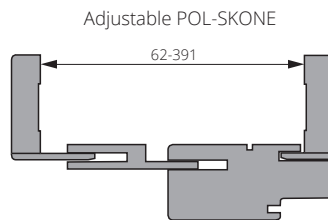
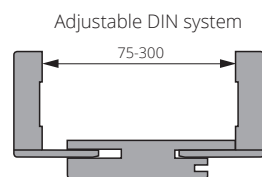
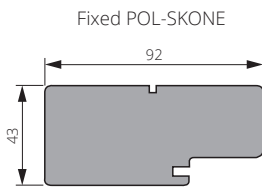

Adjustable door frames with ranges above the standard are available.

EI30 PLUS, EI60 PLUS FOR METAL DOOR FRAME

DOOR LEAF EI30 PLUS

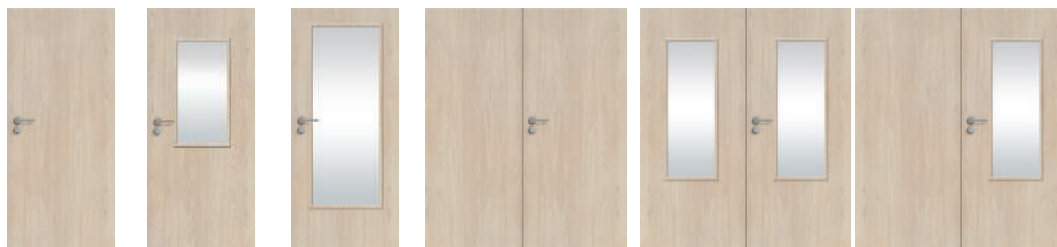

VERSION	EI30 Plus	EI30 Plus glazed (W1S, W2S, W3S)	EI30 Plus glazed (W4S)	EI30 Plus flush	EI30 Plus glazed	EI30 Plus (flush/glazed)
---------	-----------	----------------------------------	------------------------	-----------------	------------------	--------------------------

LAMINATED CPL 0.2 mm
LAMISTONE, SILKSTONE
SILKSTONE CPL 0.5 mm
UNI MAT PLUS
PAINTED
PAINTED – grey, beige
PAINTED - black, sage
VENEERED GROUP A
VENEERED GROUP B
VENEERED GROUP C, D

smoke control - extra charge single-leaf door, double-leaf door

DOOR LEAF EI60 PLUS



VERSION	EI60 Plus	EI60 Plus glazed (W1S, W3S)	EI60 Plus flush	EI60 Plus glazed	EI60 Plus (flush/glazed)
---------	-----------	-----------------------------	-----------------	------------------	--------------------------

LAMINATED CPL 0.2 mm
LAMISTONE, SILKSTONE
SILKSTONE CPL 0.5 mm
UNI MAT PLUS
PAINTED
PAINTED – grey, beige
PAINTED - black, sage
VENEERED GROUP A
VENEERED GROUP B
VENEERED GROUP C, D

smoke control - extra charge single-leaf door double-leaf door

*standard colour for wooden leaves and frames - white RAL 9003.
Colours of metal door frames (p. 223)

extra charge added to the basic colour white (RAL 9003) acc. to RAL, NCS colour groups (p. 264)

Group I	Group II	Group III	Group IV	Group V
---------	----------	-----------	----------	---------

In order to comply with the requirements of the National Technical Assessment, the leaves are sold complete with a metal door frame.

GLAZING DIMENSIONS

(within the clearance) of the fire-protection doors

FR EI30 SR 32 dB		EI30 PLUS				EI60 PLUS	
Glass pane dimension in clearance [mm]:		W1S	W2S	W3S	W4S	W1S	W3S
		Glass pane dimension in the clearance [mm]:	Glass pane dimension in the clearance [mm]:	Glass pane dimension in the clearance [mm]:	Glass pane dimension in the clearance [mm]:	Glass pane dimension in the clearance [mm]:	Glass pane dimension in the clearance [mm]:
"60"	-	166x1054	166x1384	166x1054	166x1384	166x860	166x860
"70"	169x1056			266x1054	266x1384		266x860
"80"	269x1056			366x1054	366x1384		366x860
"90"	369x1056			466x1054	466x1384		466x860
"100"	469x1056			566x1054	566x1384		566x860
"110"	-			666x1054	666x1384		566x860



ADJUSTABLE METAL door frame FOR EI30 PLUS, EI60 PLUS DOORS

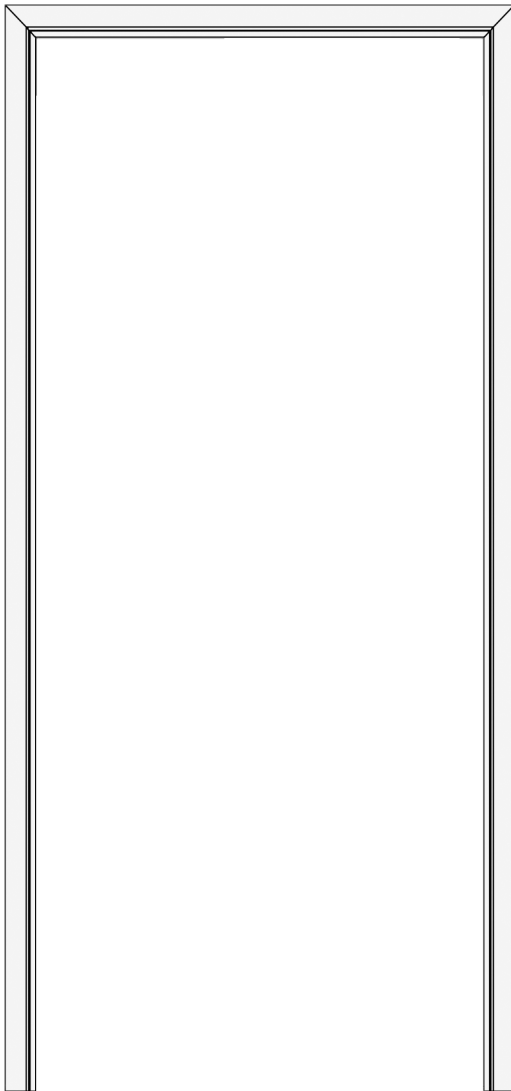

An in-wall cavity must be made for the cover boxes.

Door frame made of 1.5 mm thick metal sheet.

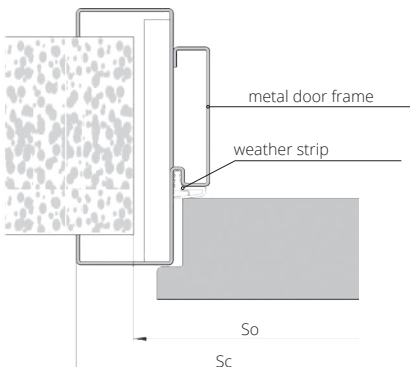

DEDICATED TO

Fire door leaves EI30 Plus, EI60 Plus

COLOURS

Powder-coated door frame.
Standard colours: white (RAL 9003), black (RAL 9005), white (RAL 9016), grey (RAL 7047), brown (RAL 8014), graphite (RAL 7024), beige (NCS S 2005 Y50R)
Other colours from the RAL palette are available at an extra charge - according to the table of extra charges (p.223)

symbol	range mm	EI30 PLUS single-leaf door (p. 166)		
		"90"	"100"	"110"
S30	100-130			
S31	130-160			
S32	160-190			
S33	190-220			
S34	220-250			
S35	250-280			
S36	280-310			
S37	310-340			
S38	340-370			
S39	370-400			

extra charge to double-leaf door **+50%**

symbol	range mm	EI60 PLUS single-leaf door (p. 170)		
		"90"	"100"	"110"
S60	100-130			
S61	130-160			
S62	160-190			
S63	190-220			
S64	220-250			
S65	250-280			
S66	280-310			
S67	310-340			
S68	340-370			
S69	370-400			

extra charge for double-leaf door **+50%**

ACCESSORIES AND EQUIPMENT

(available at extra charge)

- reinforcement for electric door strike
- reinforcement for a hidden door closer GEZE BOXER 2-4; ITS 96 2-4; ITS 96 3-6
- MC 250 mortise reed switch
- MC200-S19 mounting flange for reed switch (white colour) (for metal door frames)

WIDTH

single-leaf door					double-leaf door				
type	So	Sc	Ho	Hc	type	So	Sc	Ho	Hc
"60"	665	724			"120"	1303	1362		
"70"	765	824			"130"	1403	1462		
"80"	865	924			"140"	1503	1562		
"90"	965	1024	2055	2081	"150"	1603	1662		
"90 plus"	985	1044			"160"	1703	1762	2055	2081
"100"	1065	1124			"170"	1803	1862		
"110"	1165	1224			"180"	1903	1962		
					"190"	2003	2062		
					"200"	2103	2162		

* 90 Plus width allows for a clear opening of min. 900 mm for doors with a 90° opening angle.

So - installation opening width
Sc - total door frame width

Ho - installation opening height
Hc - door frame total height



ADJUSTABLE METAL DUO door frame FOR EI30 PLUS, EI60 PLUS DOORS

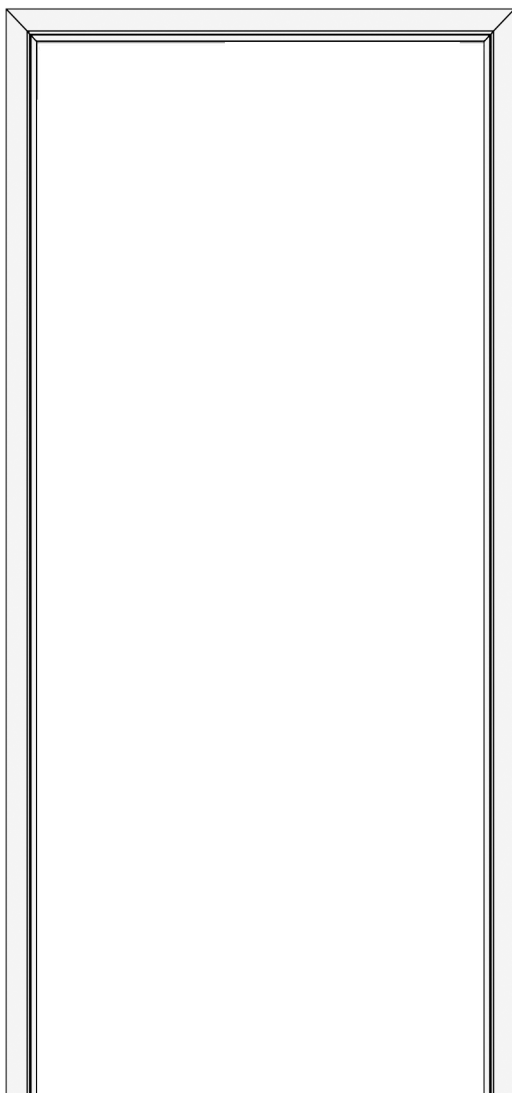

An in-wall cavity must be made for the cover boxes.

Door frame made of 1.5 mm thick metal sheet.

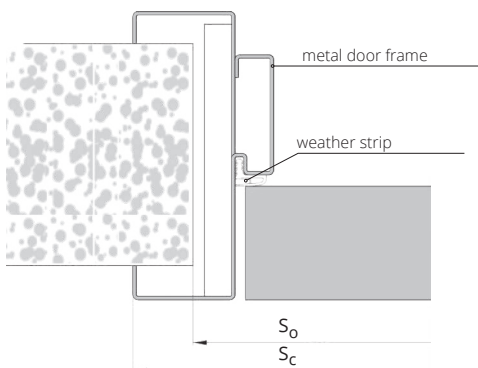

S_o - installation opening width
S_c - door frame total width
H_o - installation opening height
H_c - door frame total height

DUO metal door frames fitted with OBX ECO SCHULTE object hinges. TECTUS hidden hinges by Simonswerk available at extra charge (p. 204)

DEDICATED TO

Fire door leaves EI30 Plus, EI60 Plus

COLOURS

Powder-coated door frame. Standard colours: white (RAL 9003), black (RAL 9005), white (RAL 9016), grey (RAL 7047), brown (RAL 8014), graphite (RAL 7024), beige (NCS S 2005 Y50R). Other colours from the RAL palette are available at an extra charge - according to the table of extra charges (p.223)

symbol	range mm	EI30 PLUS single-leaf door (p. 168)		
		"90"	"100"	"110"
D30	100-130			
D31	130-160			
D32	160-190			
D33	190-220			
D34	220-250			
D35	250-280			
D36	280-310			
D37	310-340			
D38	340-370			
D39	370-400			

extra charge for double-leaf door **+50%**

symbol	range mm	EI60 PLUS single-leaf door (p. 172)		
		"90"	"100"	"110"
D60	100-130			
D61	130-160			
D62	160-190			
D63	190-220			
D64	220-250			
D65	250-280			
D66	280-310			
D67	310-340			
D68	340-370			
D69	370-400			

extra charge for double-leaf door **+50%**

ACCESSORIES AND EQUIPMENT (available at extra charge)

reinforcement for electric door strike	
reinforcement for a hidden door closer GEZE BOXER 2-4; ITS 96 2-4; ITS 96 3-6	
extra charge for hinges	p. 205
MC 250 mortise reed switch	
MC200-S19 mounting flange for reed switch (white colour) (for metal door frames)	

WIDTH					
single-leaf door			double-leaf door		
type	S _c	S _o	type	S _c	S _o
"60"	724	665	"120"	1340	1280
"70"	824	765	"130"	1440	1380
"80"	924	865	"140"	1540	1480
"90"	1024	965	"150"	1640	1580
"90"plus	1084	1025	"160"	1740	1680
"100"	1124	1065	"170"	1840	1780
"110"	1224	1165	"180"	1940	1880
			"190"	2040	1980
			"200"	2140	2080
HEIGHT			H _o	H _c	
			2055	2081	

* 90 Plus width allows for a clear opening of min. 900 mm for doors with a 90° opening angle.



FIXED METAL door frame FOR EI30 PLUS, EI60 PLUS DOORS

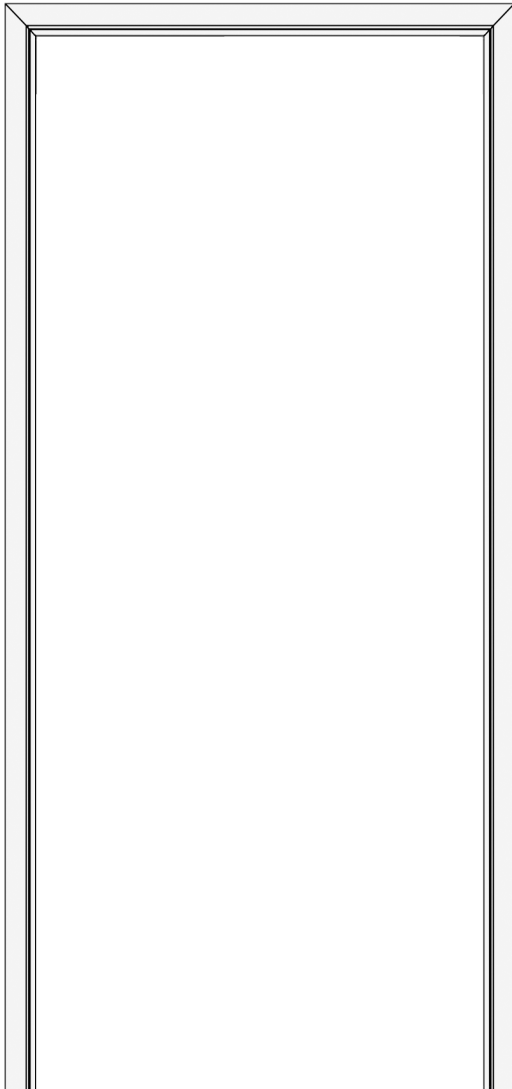

An in-wall cavity must be made for the cover boxes.

Door frame made of 1.5 mm thick metal sheet.

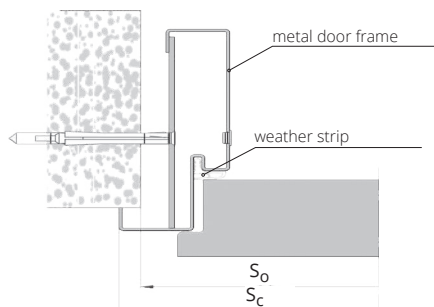

DEDICATED TO

Fire door leaves EI30 Plus, EI60 Plus

COLOURS

Powder-coated door frame.

Standard colours: white (RAL 9003), black (RAL 9005), white (RAL 9016), grey (RAL 7047), brown (RAL 8014), graphite (RAL 7024), beige (NCS S 2005 Y50R)

Other colours from the RAL palette are available at an extra charge - according to the table of extra charges (p.223)

symbol	range mm	single-leaf door EI30 PLUS (p. 166)		
		"90"	"100"	"110"
UD EI30 PLUS	100			
standard range 100 mm widths of 100-150 mm available subject to consultation with the Sales Department				
extra charge for double-leaf door +50%				

symbol	range mm	single-leaf door EI60 PLUS (p. 170)		
		"90"	"100"	"110"
UD EI60 PLUS	100			
standard range 100 mm widths of 100-150 mm available subject to consultation with the Sales Department				
extra charge for double-leaf door +50%				

ACCESSORIES AND EQUIPMENT
(available at extra charge)

- reinforcement for electric door strike
- reinforcement for a hidden door closer GEZE BOXER 2-4; ITS 96 2-4; ITS 96 3-6
- MC 250 mortise reed switch
- MC200-S19 mounting flange for reed switch (white colour) (for metal door frames)

WIDTH									
single-leaf door					double-leaf door				
type	S ₀	S _c	H ₀	H _c	type	S ₀	S _c	H ₀	H _c
"60"	680	704			"120"	1320	1342		
"70"	780	804			"130"	1420	1442		
"80"	880	904			"140"	1520	1542		
"90"	980	1004	2060	2071	"150"	1620	1642		
"90" plus	1000	1024			"160"	1720	1742	2060	2071
"100"	1080	1104			"170"	1820	1842		
"110"	1180	1204			"180"	1920	1942		
					"190"	2020	2042		
					"200"	2120	2142		

* 90 Plus width allows for a clear opening of min. 900 mm for doors with a 90° opening angle.



FIXED METAL DUO door frame FOR EI30 PLUS, EI60 PLUS DOORS

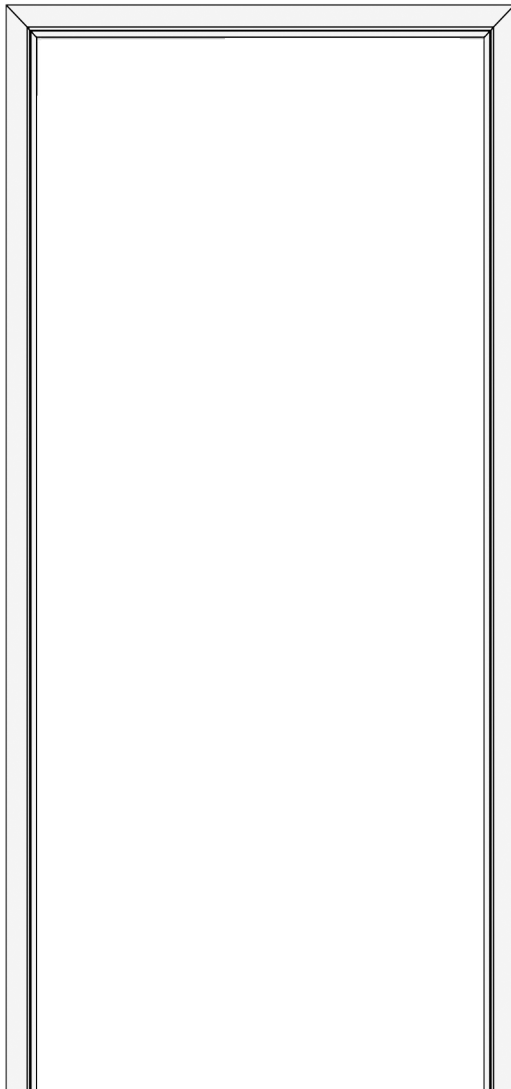

An in-wall cavity must be made for the cover boxes.

DEDICATED TO

Fire door leaves EI30 Plus, EI60 Plus

DUO metal door frames suitable for OBX ECO SCHULTE object hinges or for TECTUS hidden hinges by Simonswerk (option available at an extra charge) (p. 204)

COLOURS

Powder-coated door frame.

Standard colours: white (RAL 9003), black (RAL 9005), white (RAL 9016), grey (RAL 7047), brown (RAL 8014), graphite (RAL 7024), beige (NCS S 2005 Y50R)

Other colours from the RAL palette are available at an extra charge - according to the table of extra charges (p.223)

symbol	range mm	EI30 PLUS single-leaf door (p. 168)		
		"90"	"100"	"110"
UD EI30 PLUS	100			
standard range 100 mm widths of 100-150 mm available subject to consultation with the Sales Department				
extra charge for double-leaf door +50%				

symbol	range mm	EI60 PLUS single-leaf door (p. 172)		
		"90"	"100"	"110"
UD EI60 PLUS	100			
standard range 100 mm widths of 100-150 mm available subject to consultation with the Sales Department				
extra charge for double-leaf door +50%				

ACCESSORIES AND EQUIPMENT (available at extra charge)

reinforcement for electric door strike	
reinforcement for a hidden door closer GEZE BOXER 2-4; ITS 96 2-4; ITS 96 3-6	
extra charge for hinges	p. 205
MC 250 mortise reed switch	
MC200-S19 mounting flange for reed switch (white colour) (for metal door frames)	

Door frame made of 1.5 mm thick metal sheet.

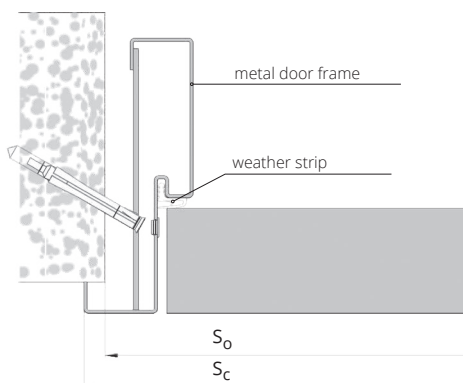

WIDTH					
single-leaf door			double-leaf door		
type	S _c	S ₀	type	S ₀	S _c
"60"	724	680	"120"	1296	1340
"70"	824	780	"130"	1396	1440
"80"	924	880	"140"	1496	1540
"90"	1024	980	"150"	1596	1640
"90"plus	1084	1040	"160"	1696	1740
"100"	1124	1080	"170"	1796	1840
"110"	1224	1180	"180"	1896	1940
			"190"	1996	2040
			"200"	2096	2140
HEIGHT			H ₀	H _c	
			2060	2081	

* 90 Plus width allows for a clear opening of min. 900 mm for doors with a 90° opening angle.

BESPOKE SYSTEMS WITH ARCHITRAVES

FOR CERBER PLUS, CERBER PLUS RC2, B-30, C-30, RC3,
E130 POL-SKONE SYSTEM, E130 PLUS, E160 PLUS, SR37 DOORS

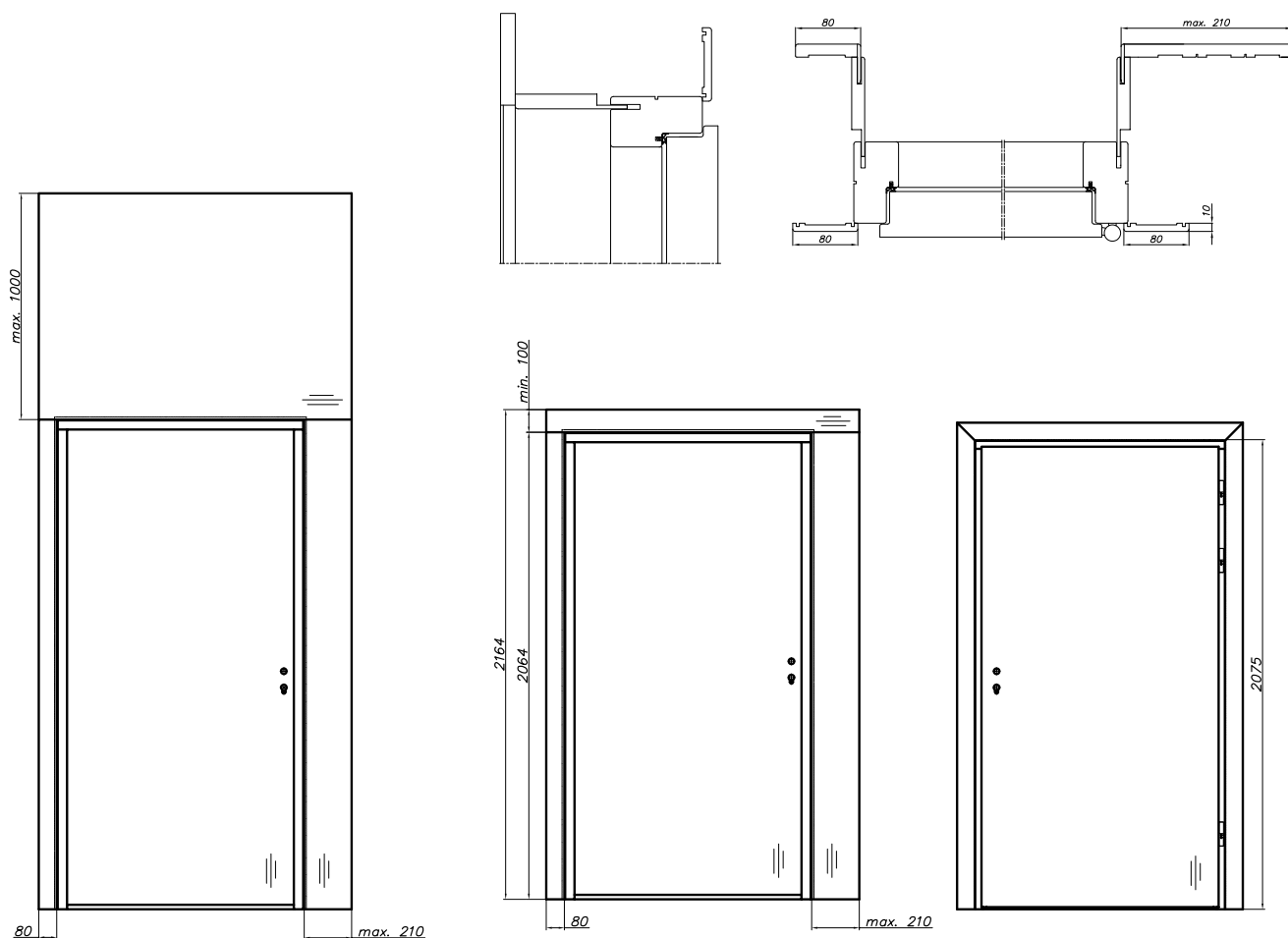

Upper panel with a maximum width of 1220 mm available with vertical and horizontal wood grain.
Upper panel with a width over in 1220 mm - only horizontal grain available.
Upper panel in veneer available with vertical and horizontal wood grain.

PANELLING SYSTEM WITH ARCHITRAVES (adjustment panel 16 mm + moulding 80 mm + vertical architraves 210 mm/80 mm) - without upper wall panel

for the single-leaf door						ECO TOP	UNI MAT PLUS	HIGH TOP	PAINTED white 001*	PAINTED grey, beige	BLACK SAGE	VENEERED		
symbol	range [mm]	symbol	range [mm]	symbol	range [mm]			LAMISTONE CPL				GROUP A	GROUP B	GROUP C, D
B-30, C-30, RC3, SR37, E130 POL-SKONE SYSTEM, E130 PLUS		CERBER PLUS, CERBER PLUS RC2		E160 PLUS										
							SILKSTONE							
							for the laminated type							
FY1	144-169	FU1	136-161	FW1	164-189									
FY2	169-194	FU2	161-186	FW2	189-214									
FY3	194-219	FU3	186-211	FW3	214-239									
FY4	219-244	FU4	211-236	FW4	239-264									
FY5	244-269	FU5	236-261	FW5	264-289									
FY6	269-294	FU6	261-286	FW6	289-314									
FY7	294-319	FU7	286-311	FW7	314-339									
FY8	319-344	FU8	311-336	FW8	339-364									
FY9	344-369	FU9	336-361	FW9	364-389									

* RAL, NCS palette colours (except metallic ones) - extra charge acc. to the colour table

FU - CASING FOR CERBER PLUS, CERBER PLUS RC2 DOOR

FY - CASING FOR B-30, C-30, RC3, E130 POL-SKONE SYSTEM, E130 PLUS, SR 37 Db DOOR

FW - SYSTEM FOR E160 PLUS DOOR

PRICE OF CASING = PRICE OF CASING WITH ARCHITRAVES + PRICE OF UPPER PANEL [m²] - p. 184

BESPOKE PANELLING SYSTEMS

FOR CERBER PLUS, CERBER PLUS RC2, B-30, C-30, RC3, EI30 POL-SKONE SYSTEM, EI30 PLUS, EI60 PLUS, SR37 DOOR

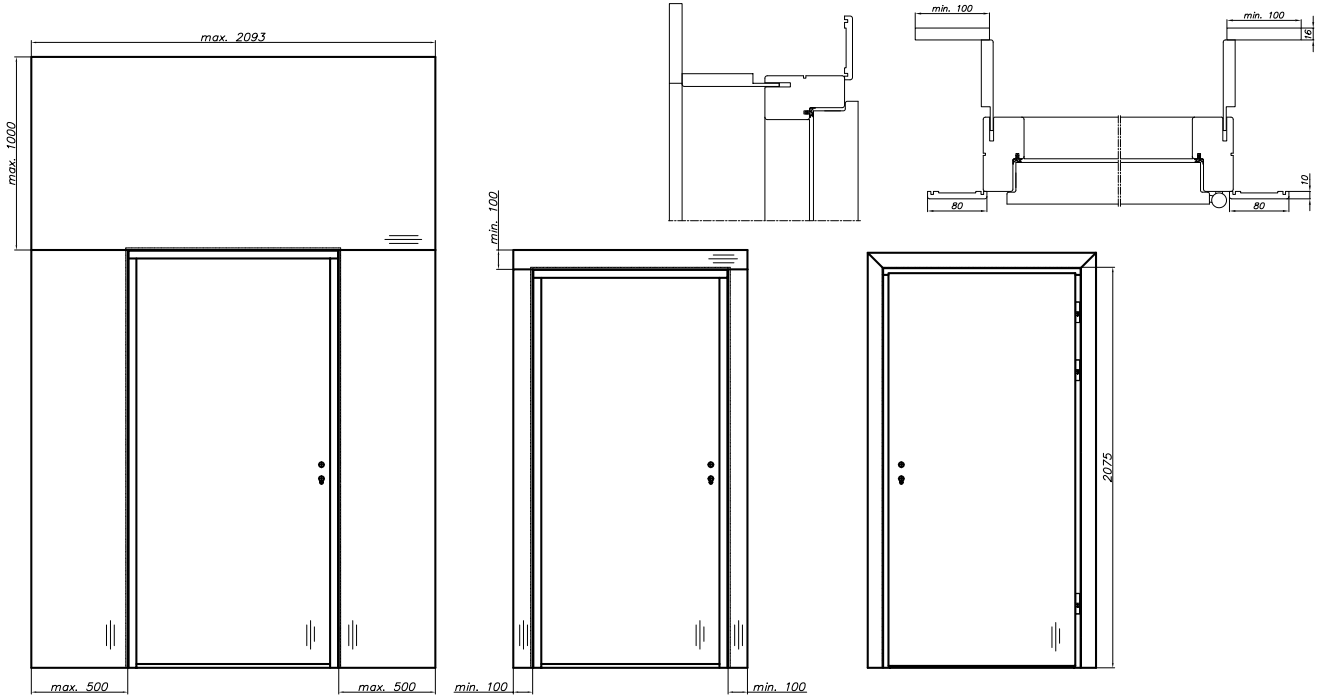

Upper panel with a maximum width of 1220 mm available with vertical and horizontal wood grain.
 Upper panel with a width over in 1220 mm - only horizontal grain available.
 Upper panel in veneer available with vertical and horizontal wood grain.

PANELLING SYSTEM (adjustment panel 16 mm + moulding 80 mm) - without wall panels

for the single-leaf door						ECO TOP	UNI MAT PLUS	HIGH TOP	PAINTED white 001*	PAINTED grey, beige	BLACK RAL 9005 SAGE NCS S 4010-G50Y	VENEERED		
B-30, C-30, RC3, SR37, EI30 POL-SKONE SYSTEM, EI30 PLUS		CERBER PLUS, CERBER PLUS RC2		EI60 PLUS				LAMISTONE CPL				GROUP A	GROUP B	GROUP C, D
symbol	range [mm]	symbol	range [mm]	symbol	range [mm]			SILKSTONE laminated						
FZ1	144-169	FV1	136-161	FX1	164-189									
FZ2	169-194	FV2	161-186	FX2	189-214									
FZ3	194-219	FV3	186-211	FX3	214-239									
FZ4	219-244	FV4	211-236	FX4	239-264									
FZ5	244-269	FV5	236-261	FX5	264-289									
FZ6	269-294	FV6	261-286	FX6	289-314									
FZ7	294-319	FV7	286-311	FX7	314-339									
FZ8	319-344	FV8	311-336	FX8	339-364									
FZ9	344-369	FV9	336-361	FX9	364-389									

(*) RAL, NCS system colours (except metallic ones) - extra charge acc. to the colour table

PANELLING SYSTEM (adjustment panel NRO 16 mm + moulding 80 mm) - without NRO wall panels

for the single-leaf door						ECO TOP	LAMISTONE CPL	PAINTED white	PAINTED grey, beige	BLACK RAL 9005 SAGE NCS S 4010-G50Y	VENEERED		
B-30, C-30, RC3, SR37, EI30 POL-SKONE SYSTEM, EI30 PLUS		CERBER PLUS, CERBER PLUS RC2		EI60 PLUS			SILKSTONE				GROUP A	GROUP B	GROUP C, D
symbol	range [mm]	symbol	range [mm]	symbol	range [mm]								
FZ1	144-169	FV1	136-161	FX1	164-189								
FZ2	169-194	FV2	161-186	FX2	189-214								
FZ3	194-219	FV3	186-211	FX3	214-239								
FZ4	219-244	FV4	211-236	FX4	239-264								
FZ5	244-269	FV5	236-261	FX5	264-289								
FZ6	269-294	FV6	261-286	FX6	289-314								
FZ7	294-319	FV7	286-311	FX7	314-339								
FZ8	319-344	FV8	311-336	FX8	339-364								
FZ9	344-369	FV9	336-361	FX9	364-389								

FV - SYSTEM FOR CERBER PLUS, CERBER PLUS RC2 DOORS

FZ - SYSTEM FOR B-30, C-30, RC3, EI30 POL-SKONE SYSTEM, EI30 PLUS, SR37 Db DOORS

FX - SYSTEM FOR EI60 PLUS DOOR

PRICE OF SYSTEM = PRICE OF PANELLING SYSTEM + PRICE OF WALL PANEL [m²]
 (VERTICAL + UPPER PANELS) - p. 184

NEW SOLUTION FOR PUBLIC UTILITY BUILDINGS

ABS EDGING



WITHOUT AN EXTRA CHARGE

The ABS edging offers an advantage of being highly resistant to mechanical damages and moisture.



PRODUCT RECOMMENDED BY EXPERTS
CHOICE OF DEVELOPERS

rebated system for interior doors

NON-REBATED SYSTEM
(EXCEPT REVES, HARMONY ODW)

DEDICATED TO LOFTY, IMPULS,
HAPTIC, DECO DOORS



titano

white

Polish oak

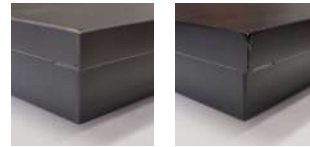

anthracite

black

AVAILABILITY OF 0.8 MM ABS EDGING

applies to HAPTIC, DECO, IMPULS doors in the non-rebated system

3 edges protection

4 edges protection

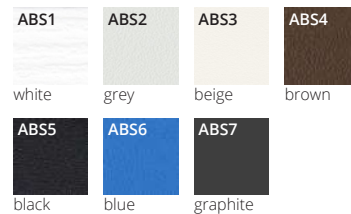

ABS1

ABS2

ABS3

ABS4

white

grey

beige

brown

black

blue

graphite

WALL PANELS

Wall panels can be used as a durable wall lining in offices, conference rooms, living areas, study rooms or public utility buildings. The wide range of colours makes it possible to match an appropriate décor to the room and the door systems of the building.

- The wall panels are made of 16 mm thick MDF board with a decorative coating on both sides.
- The wall panels classified as fire-retardant acc. to EN 13501-1+A1:2010 are made of 16 mm thick MDF board with class Bs1 d0 reaction to fire, covered with decorative coating on both sides.



Wall paneling system

extra charge added to the basic colour white (RAL 9003) acc. to RAL, NCS colour groups (p. 264) - **extra charge for one panel (element).**

Group I	Group II	Group III
Group IV	Group V	

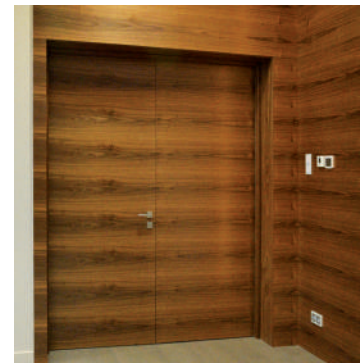

NRO WALL PANELS

ECO TOP	SILKSTONE	LAMISTONE	PAINTED* (RAL 9003)	VENEERED GROUP A	VENEERED GROUP B	VENEERED GROUP C, D
---------	-----------	-----------	---------------------	------------------	------------------	---------------------



NRO panels classified as flame-retardant

price per 1 m² (exact dimensions of panels available subject to consultation with the Sales Department)

WALL PANELS

ECO TOP	SILKSTONE	UNI MAT PLUS	LAMISTONE	LAMINATE CPL 0.2 mm	SILKSTONE CPL 0.5 mm	PAINTED (RAL 9003)	VENEERED GROUP A	VENEERED GROUP B	VENEERED GROUP C, D
---------	-----------	--------------	-----------	---------------------	----------------------	--------------------	------------------	------------------	---------------------

price per 1 m² (exact dimensions of panels available subject to consultation with the Sales Department)

DIMENSIONS

Laminated panels for doors with a board structure and a structure based on panels, rails and stiles
dimensions: max. width: 1100 mm, max. height 2500 mm

Veneered panels for doors with a board structure and a structure based on panels, rails and stiles
dimensions: max. width: 1100 mm, max. height 2500 mm

FINISH

Veneered surface, covered with LAMISTONE, SILKSTONE, ECO TOP laminate, painted or CPL laminate.
Wood grain of panels with a max. width of 1100 mm – vertical or horizontal.
Wood grain of panels with a width over 1100 mm - only horizontal wood grain available.

INSTALLATION

Special-purpose installation glue.

* Only in the colour of white RAL 9003

minimum width of wall panel 100 mm

dimensions: max. width: 1100 mm, max. height 2500 mm

extra charge added to dimensions 2301- 2500 mm +10% to m² price

extra charge added to dimensions 80- 299 mm +10% to m² price

for veneered panels with a height of 2200-2500 mm, veneer can be comb-joined.

DOORS FOR SHAFTS

- It is recommended to use EI30 Plus, EI60 Plus fire door on a fixed wooden frame with an optional door on-wall panelling system classified as flame-retardant.
- Door equipped with mortise lock with cylinder-ready hole without handle.
- For shaft doors where there occurs a temperature difference between the two rooms, ventilation grilles are recommended as a ventilation option.



TWO-COLOUR DOORS



two-colour door leaf, single-colour door frame

two-colour door leaf, two-colour door frame

TWO-COLOUR DOORS ARE AVAILABLE (INTERIOR AND TECHNICAL DOORS)

Board-based structure only, except rail, stile and panel structure. Colours only from the same colour group e.g. ECO TOP+ECO TOP, LAMISTONE+LAMISTONE, CPL 0.2+CPL 0.2, HPL+HPL

two-colour door leaf / single-colour door frame	without an extra charge
two-colour door leaf / two-colour door frame	without an extra charge

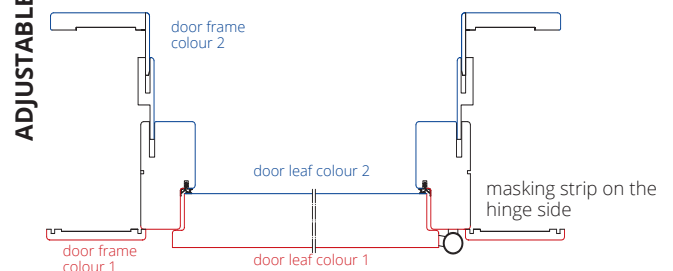
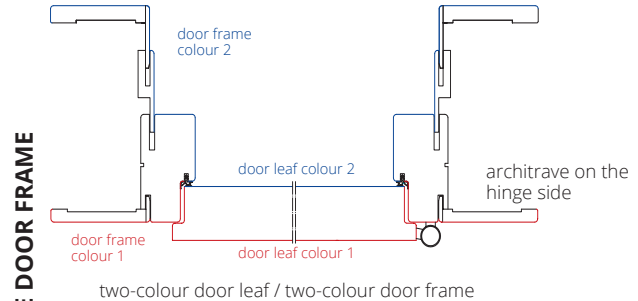
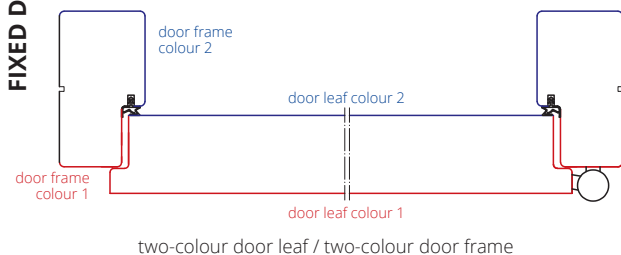
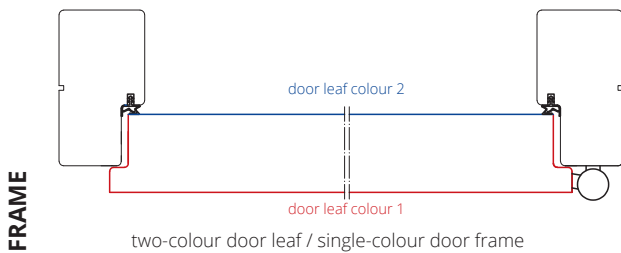

FIRE PROTECTION SIDELIGHTS / TOPLIGHTS



SIDELIGHTS AND TOPLIGHTS

sidelight/toplight price = price of 1mbx2 (A+B) + price of 1sq.m. of glass x A X B

area	(price per 1 m)
ECO TOP	
LAMINATED CPL	
HIGH TOP	
LAMISTONE	
SILKSTONE	
PAINTED – white	
PAINTED – grey, beige	
PAINTED – black, sage	
VENEERED GROUP A	
VENEERED GROUP B	
VENEERED GROUP C, D	
standard: transparent fireproof glass (m ²)	

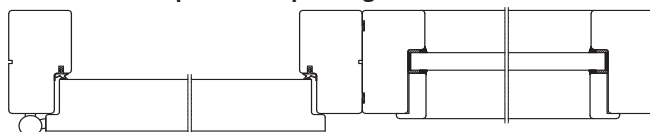

Sidelights and toplight on fixed door frame profile

- fire resistance: EI30
- transparent fireproof glass
- maximum size of sidelights 944 mm x 2175 mm
- maximum size of toplights 2152 mm x 425 mm
- minimum dimension sidelight/toplight one side 300 mm

Sidelights/toplights are sold in compliance with the National Technical Assessment ITB-KOT-2020/1370 issue 1 and only in together with the FR EI30 POL-SKONE system fire door. EI30 sidelights/toplights with EI30 PLUS doors are available subject to an individual approval.

DECORATION ELEMENTS

The visual aspect is playing an increasingly important role in the architecture of public utility buildings. This applies to both the body of the building itself and to all components of its equipment. We offer technical doors with additional decorative elements: mouldings of various shapes, aluminium and in the colour of the door leaf, fluting in various styles, door leaf and door frame edge protectors with a stainless steel application, wall panels.

It is recommended to use perforated or solid chipboard in-fill.

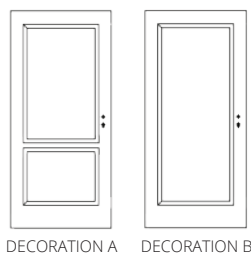

DECORATION A DECORATION B



DECORATION C

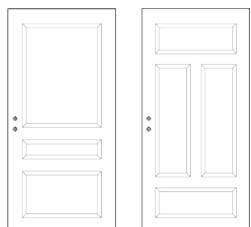

DECORATION D DECORATION E

DECORATION A, B (ONE-SIDED)

	ECO TOP	HIGH TOP	LAMISTONE	SILKSTONE	UNI MAT PLUS
decoration A					
decoration B					

PAINTED	VENEERED GROUP A	VENEERED GROUP B	VENEERED GROUP C
---------	------------------	------------------	------------------

DECORATION C (ONE-SIDED)

PAINTED	VENEERED GROUP A	VENEERED GROUP B	VENEERED GROUP C
---------	------------------	------------------	------------------

DECORATION D, E (ONE-SIDED)

	ECO TOP	UNI MAT PLUS	HIGH TOP	LAMISTONE	SILKSTONE
decoration D					
decoration E					

PAINTED	VENEERED GROUP A	VENEERED GROUP B	VENEERED GROUP C
---------	------------------	------------------	------------------

decoration D
decoration E

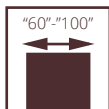

SPECIAL HIGRO

Non-rebated system door. The leaf structure consists of a polyurethane rail and stile set reinforced with plywood and topped on both sides with HPL laminate with a thickness of 2mm. The in-fill is made of a special thermal insulation core.

The door is designed for residential, public utility, industrial and warehouse buildings as interior door used to close openings within interior walls between rooms. The door is designed for interiors in which the permissible relative air humidity is up to 90% and the temperature does not exceed 65°C.

The door must not be directly exposed to water.

Door specially designed for rooms with increased relative humidity and temperature in accordance with the manufacturer's instructions for use.

If door is installed in areas with high chlorine concentrations, there is a risk of corrosion occurring on stainless steel hardware, panels and portholes.

mechanical class: class 2 mechanical strength requirements, i.e. average operation conditions
resistance to climatic conditions: class 3 acc. to PN-EN 12219:2002
door approved for marketing based on the PN-EN 14351-2:2018 standard

Higro door, W02 pattern, metal fixed non-rebated Higro door frame



Higro door, W03 pattern, metal adjustable non-rebated Higro door frame



HIGRO

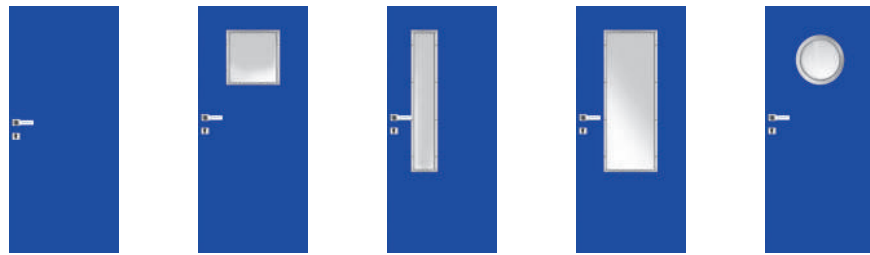

VERSION	W00	W01	W02	W03	W04
---------	-----	-----	-----	-----	-----

H-01 (grey), H-02 (white),
H-05 (blue), H-06 (anthracite)

steel fixed HIGRO door frame in the
colour of RAL 9016, RAL 7047,
RAL 5010, RAL 7024, width "60" - "100"

ADJUSTABLE NON-REBATED DOOR FRAME FOR HIGRO DOOR LEAVES

for the single-leaf door		
VERSION	wall width range [mm]	"60" - "100"
FD71	110-140	
FD72	140-170	
FD73	170-200	
FD74	200-230	
FD75	230-260	
FD76	260-290	
FD77	290-320	
FD78	320-350	
FD79	350-380	

standard: white (RAL 9016), grey (RAL 7047),
blue (RAL 5010), anthracite (RAL 7024)

extra charge for 1 piece of the extra TECTUS hinge by SIMONSWERK,
stainless steel - complete set (top and bottom)

ACID-RESISTANT SHEET PANELS (1 set)

	width "60"	width "70"	width "80"	width "90"	width "90 plus", "100"
variant A					
variant D					
variant E, F, G, H					
	polished or brushed sheet				

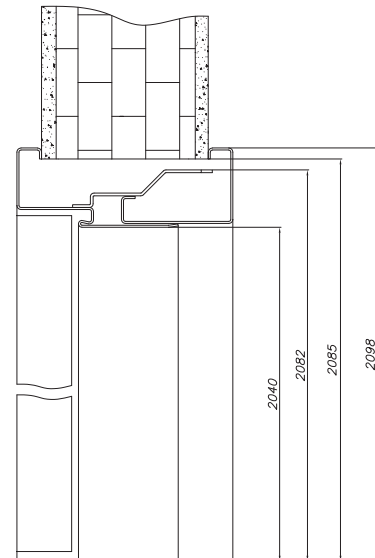
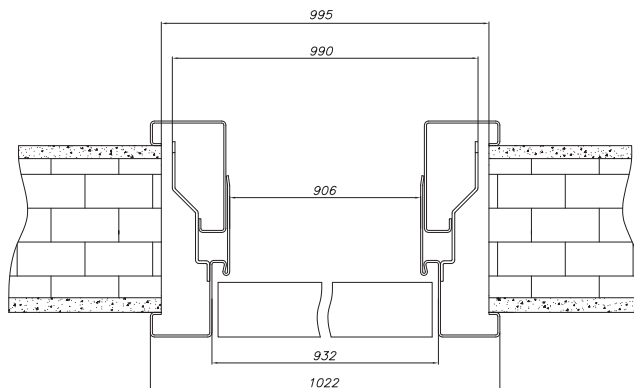

DOOR DIMENSIONS

fixed metal HIGRO door frame:

Single-leaf door:
"60" - 702x2088 mm, "70" - 802x2088 mm, "80" - 902x2088 mm,
"90" - 1002x2088 mm, "90 plus" - 1027x2088 mm
max. width of "100" - 1102 mm, max. height 2288 mm
- door lower by 55 mm or 100 mm - **without an extra charge**
- door with a height of 2188 mm **+10%**
- door with a height of 2288 mm **+20%**

Adjustable metal HIGRO door frame:

Single-leaf door:
"60" - 722x2098 mm, "70" - 822x2098 mm, "80" - 922x2098 mm,
"90" - 1022x2098 mm, "90 plus" - 1047x2098 mm
max. width of "100" - 1122 mm, max. height 2298 mm
- door lower by 55 mm or 100 mm - **without an extra charge**
- door with a height of 2198 mm **+10%**
- door with a height of 2298 mm **+20%**

DOOR LEAF FINISH

Plain surface covered with HPL 2 mm thick laminate.

GAZINGS

White matt 4 mm tempered glass pane or white matt 4 mm thick safety glass.

DOOR FRAMES

Metal fixed non-rebated door frame with rabbet seal made of galvanised 1.5 mm thick sheet.

Metal adjustable non-rebated door frame made of galvanised 1.5 mm thick sheet in the colour of the door leaf surface.

ACCESSORIES AND EQUIPMENT

Standard equipment:

- mortise single-point lock, spacing: 72 mm
- stainless steel hinges, power painted in the colour of grey RAL 7047 (2 pcs)
- pattern W04: porthole BMD3, lacomat glass pane

Additional equipment:

- surface-mounted door closer
- drop seal
- acid-resistant steel ventilation grill
- Higo handle and Higo lower rose made of stainless steel
- stainless steel panels glued to the door leaf bottom or at the handle height
- additional ZOXX adjustment system for the non-rebated adjustable door frame (wall width range increase 650 mm)
- roller lock with a stainless steel face plate
- stainless steel porthole - lacomat/transparent glass (extra charge to version W04)

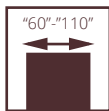

SPECIAL GAMMA

Door in the rebated system. The door leaf structure consists of a rail and stile set made of coniferous wood, topped on both sides with 5 mm thick HDF boards with a 1 mm thick lead insert (total thickness of the lead insert: 2 mm for a door leaf). The in-fill is made of chipboard. Door designed for public utility buildings (hospitals, medical centres and doctors' offices) and industrial and warehouse buildings - as interior entrance doors installed to close openings within interior walls between a corridor and rooms where X-radiation is emitted.

mechanical class: class 3 of mechanical strength requirements, i.e. heavy service conditions
acoustic insulation
class $D_1 - 35$, $D_2 - 35$, class $R_w=37$ dB
door approved for marketing subject to PN-EN 14351-2:2018

GAMMA door, fixed metal door frame



GAMMA door, fixed metal door frame



GAMMA



GAMMA FIXED WOODEN DOOR FRAME

VERSION for the single-leaf door
 LAMISTONE CPL
 SILKSTONE
 PAINTED
 VENEERED GROUP A
 VENEERED GROUP B
 VENEERED GROUP C

VERSION single-leaf door

LAMISTONE CPL
 SILKSTONE
 LAMINATED CPL 0.5 mm
 LAMINATED CPL 0.7 mm
 PAINTED
 VENEERED GROUP A
 VENEERED GROUP B
 VENEERED GROUP C, D

MOULDING LD6 GAMMA LD6 MOULDING

VERSION for the single-leaf door
 LAMISTONE CPL
 SILKSTONE
 PAINTED
 VENEERED GROUP A
 VENEERED GROUP B
 VENEERED GROUP C

GAMMA ADJUSTABLE WOODEN DOOR FRAME

for the single-leaf door							
VERSION	range in [mm]	ECO TOP	HIGH TOP LAMISTONE SILKSTONE	PAINTED	VENEERED GROUP A	VENEERED GROUP B	VENEERED GROUP C
ZG1	92-112						
ZG2	112-136						
ZG3	136-180						
ZG4	180-202						
ZG5	202-246						
ZG6	246-268						
ZG7	268-312						
ZG8	312-334						
ZG9	334-378						
ZG10	378-402						

GAMMA METAL DOOR FRAME WITH LEAD SHEET STRIP

DOOR FRAME TYPE	wall width range [mm]	width in clearance "60" - "90"	
FIXED FD12	ZO1 (95-125)		
	ZO2 (125-155)		
	ZO3 (155-185)		
	ZO4 (185-215)		
	ADJUSTABLE	ZO5 (215-245)	
		ZO6 (245-275)	
		ZO7 (275-305)	
		ZO8 (305-335)	
		ZO9 (335-365)	

DOOR DIMENSIONS

Fixed or adjustable wooden door frame:
 single-leaf door:
 max. width: "110" – 1195 mm, max. height 2067 mm
Fixed metal door frame:
 single-leaf door:
 max. width: "110" – 1197 mm, max. height 2068 mm
Adjustable metal door frame:
 single-leaf door:
 max. width: "110" – 1217 mm, max. height 2078 mm

Double-leaf door are approved for marketing based on the Individual Technical Documentation and subject to consultation with the Sales Department.

DOOR LEAF FINISH

Plain surface painted, veneered, covered with CPL laminate with a thickness of 0.5 to 0.7 mm, HPL laminate with a thickness of 0.7 to 1.0 mm or wood-alike foil.

DOOR FRAMES

Fixed or GAMMA wooden door frame with lead insert.
Fixed or adjustable GAMMA METAL door frame with of 1.5 mm metal sheet with lead insert. Standard powder-coated in the colour

of white (RAL 9016 and RAL 9003), grey (RAL 7047), brown (RAL 8014), beige (RAL 1001), graphite (RAL 7024) and black (RAL 9005).

ACCESSORIES AND EQUIPMENT

Standard equipment:
 - single-point mortise lock
 - 3 pcs of object angular hinges - width "60"- "110"
 - drop seal

Additional equipment:
 - stainless steel panels glued to the door leaf bottom or at the handle height
 - door closer, electric strike, electromagnetic lock
 - width "100" **+10%**
 - width "110" **+20%**

non-rebated
SYSTEM

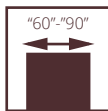

SPECIAL SWING DOORS



Doors intended for use in the construction industry as interior door (without fire resistance or acoustic properties) to close openings in interior walls between rooms. Door specially designed for catering outlets.

Flush or glazed door leaf in the non-rebated system. The leaf structure consists of a rail and stile set made of coniferous wood, topped with HDF boards on both sides. The standard in-fill is a honeycomb-structured layer (optionally: perforated chipboard). The rated door leaf thickness is 40 mm.

- Class 2 mechanical strength acc. to the PN-EN 1192:2001 standard
- National Technical Assessment ITB-KOT-2020/1608 issue 1

SWING door, 00 pattern, fixed wooden door frame



SWING door, 00 pattern, with porthole, fixed wooden door frame



SWING DOOR



VERSION	00	00 with porthole	02	00	00 with porthole
---------	----	------------------	----	----	------------------

- PAINTED
- UNI MAT PLUS
- LAMISTONE CPL
- SILKSTONE
- LAMINATED CPL 0.5 mm
- LAMINATED CPL 0.7 mm
- VENEERED GROUP A
- VENEERED GROUP B
- VENEERED GROUP C, D
- BLACK (RAL 9005)

**PRICE OF SINGLE-LEAF DOOR = PRICE OF SELECTED DOOR LEAF
+ PRICE OF FIXED WOODEN REBATED DOOR FRAME
+ EXTRA CHARGE**

**PRICE OF DOUBLE-LEAF DOOR = 2 x PRICE OF SELECTED DOOR LEAF
+ PRICE OF FIXED WOODEN REBATED DOOR FRAME FOR DOUBLE-LEAF DOOR
+ EXTRA CHARGE**

DIMENSIONS OF SWING DOORS

width "60"	769x2076 mm	width "60"+"60"	1418x2076 mm
width "70"	869x2076 mm	width "70"+"70"	1618x2076 mm
width "80"	969x2076 mm	width "80"+"80"	1818x2076 mm
width "90"	1069x2076 mm	width "90"+"90"	2018x2076 mm

DOOR DIMENSIONS

Wooden fixed door frame:

Single-leaf door:
max. width "90" – 1069 mm, max. height 2276 mm
Double-leaf door:
max. width: "90+90" – 2018 mm, max. height: 2276 mm

DOOR LEAF FINISH

Plain surface painted, veneered, covered with CPL laminate with a thickness of 0.2 to 0.7 mm, HPL laminate of 0.7 to 1.0 mm or wood-alike foil.

GLAZINGS

Standard 4 mm thick tempered or optionally laminated glass.

DOOR FRAMES

Door frame painted, veneered, covered with CPL 0.15 mm laminate or foil matched to the colour of the door leaf.

Fixed wooden pine door frame – optionally with masking mouldings.

ACCESSORIES AND EQUIPMENT

Standard equipment:

- swing hinge: height to 2076 mm - 3 pcs
height 2176 mm or 2276 mm – 4 pcs

Additional equipment:

- roller lock
- porthole
- stainless steel panels
- swing hinges in the colour of black - **without an extra charge**



INTERIOR REINFORCED G46



Door intended for public utility projects, optionally adapted for hidden door closer (single-leaf door), electric strikes with cable routing and semi-automatic shootbolts compatible with automatic door closers equipped with the closing sequence control (double-leaf doors).

Door leaf in rebated system. The leaf structure consists of a rail and stile set made of coniferous wood, topped with HDF boards on both sides. The infill is a solid or perforated chipboard.

The rated door leaf thickness is 46 mm.

G46 door, fixed wooden door frame



G46 door, fixed wooden door frame

DOOR WITH DIN G46 ADJUSTABLE DOOR FRAME

PRICE OF SINGLE-LEAF REINFORCED INTERIOR G46 DOOR = (PRICE OF FLAT FLASH DOOR LEAF, REBATED SYSTEM + PERFORATED CHIPBOARD IN-FILL) **+15%** + PRICE OF DIN G46 ADJUSTABLE DOOR FRAME

PRICE OF DOUBLE-LEAF REINFORCED INTERIOR G46 DOOR = (2 X PRICE OF FLAT FLASH DOOR LEAF, REBATED SYSTEM + PERFORATED CHIPBOARD IN-FILL) **+15%** + PRICE OF DIN G46 ADJUSTABLE DOOR FRAME FOR DOUBLE-LEAF DOOR

DOOR WITH FD12 FIXED METAL DOOR FRAME

PRICE OF SINGLE-LEAF REINFORCED INTERIOR G46 DOOR = (PRICE OF FLAT FLASH DOOR LEAF, REBATED SYSTEM + PERFORATED CHIPBOARD IN-FILL + PRICE OF FIXED METAL DOOR FRAME) **+15%**

PRICE OF DOUBLE-LEAF REINFORCED INTERIOR G46 DOOR = (2 X PRICE OF FLAT FLASH DOOR LEAF, REBATED SYSTEM + PERFORATED CHIPBOARD IN-FILL + PRICE OF FIXED METAL DOOR FRAME FOR DOUBLE-LEAF DOOR) **+15%**

DIN G46 ADJUSTABLE DOOR FRAME

for the single-leaf door		LAMISTONE CPL	PAINTED white 001*	PAINTED beige, grey*	BLACK RAL 9005 SAGE NCS S 4010-G50Y	VENEERED		
symbol	range [mm]	SILKSTONE				GROUP A	GROUP B	GROUP C, D
		for the laminated type						
		UNI MAT PLUS						
ZU1	77-87							
ZU2	87-112							
ZU3	112-132							
ZU4	132-152							
ZU5	152-172							
ZU6	172-192							
ZU7	192-212							
ZU8	212-232							
ZU9	232-252							
ZU10	252-272							
ZU11	272-292							
ZU12	292-312							
double-leaf door - extra charge +50%								
reinforcement for door closer 10								
* RAL, NCS palette colours (except metallic ones) - extra charge acc. to the colour table								

extra charge CPL 0.5 mm, CPL 0.7 mm to door in CPL laminate coating
(extra charge to standard door height)

CPL 0.5 mm ("60" - "90")	CPL 0.7 mm ("60" - "90")	CPL 0.5 mm ("90+" - "110")	CPL 0.7 mm ("90+" - "110")

WHEN USING HIDDEN OR SURFACE-MOUNTED DOOR CLOSERS, IT IS NECESSARY TO ORDER 4 HINGES FOR WIDTHS "90"- "100".

DOOR DIMENSIONS	G46 door, single-leaf door adjustable DIN door frame: "100" - max. width 1046, max. height 2243 mm FD12 fixed metal door frame: "100" - max. width 1097, max. height 2268 mm	G46 door, double-leaf door adjustable DIN door frame: „100+“, 100" - max. width 2080, max. height 2243 mm FD12 fixed metal door frame: „100+“, 100" - max. width 2131, max. height 2268 mm
DOOR LEAF FINISH	Plain surface painted, veneered, covered with CPL laminate with a thickness of 0.2 to 0.7 mm, HPL laminate with a thickness of 0.7 to 1.0 mm or wood-alike foil. Flat decorations, made of decorative profiled mouldings, aluminium decors available (subject to the consultation with the Sales Department).	
DOOR FRAMES	Door frame painted, veneered, covered with CPL 0.15 mm, CPL 0.2 mm laminate or foil matched to the colour of the door leaf. DIN adjustable door frame – made of 22 mm thick MDF panels.	FD12 fixed metal door frame made of 1.5 mm thick steel sheet with rabbet seal. Door frames, standard powder-coated in the colour of white (RAL 9016 and RAL 9003), grey (RAL 7047), brown (RAL 8014), beige (RAL 1001), graphite (RAL 7024), black (RAL 9005). Door frames painted in non-standard colours from RAL or NCS palettes are available upon consultation with the Sales Department.
ACCESSORIES AND EQUIPMENT	Standard equipment: - perforated chipboard door with the DIN adjustable door frame - 3 adjustable type K pivot hinges or optionally 3 type T three-part hinges - latch-and-deadbolt lock for cylinder or key door with the FD12 metal door frame - 3 type T three-part hinges - latch-and-deadbolt lock for cylinder or key - no ventilation options in the form of ventilation grills or ventilation tubes	Additional equipment: - hidden Dormakaba ITS 96 2-4 or Geze Boxer 2-4 door closer, - surface-mounted door closer - additional mortise or surface-mounted lock - electromagnetic lock - colours of SILKSTONE CPL 0.5 - drop seal - reinforcement for door closer - solid chipboard in-fill - electric NC or NO strike with cable routing - ventilation undercut, ventilation slot or panel with ventilation area Additionally for double-leaf doors - electric NC or NO strike with cable routing - semi-automatic shootbolts - surface-mounted door closers with closing sequence control

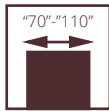

90 PLUS
WIDTH
FOR PUBLIC
UTILITY
BUILDINGS



REINFORCED DECO INVEST

In POL-SKONE leaves with a metal door frame and a door closer, type T hinges ("70"- "80"- 3 pcs, "90"- "110"- 4 pcs) are used as a standard.

MECHANICAL CLASS III

Door built of a rail and stile set made of coniferous wood, topped with HDF boards on both sides; the in-fill is made of perforated chipboard. The leaf edge is protected with a stainless steel profile. Fixed metal FD12 door frame, optionally adjustable.

The door has the mechanical class 3.

- mechanical class 3 (single-leaf door)
- mechanical class 2 (double-leaf door)
- National Technical Assessment ITB-KOT-2021/2041 issue 1

DECO INVEST door, 04 pattern, metal door frame



DECO INVEST door, 02 pattern, metal door frame

DECO INVEST DOOR LEAVES



VERSION	00	01	02	03	04
LAMISTONE CPL	"70"- "90", "90 plus" "100" "110"				
LAMINATED CPL 0.2 mm	"70"- "90", "90 plus" "100" "110"				
LAMINATED CPL 0.5 mm	"70"- "90", "90 plus" "100" "110"				
LAMINATED CPL 0.7 mm	"70"- "90", "90 plus" "100" "110"				
DOUBLE LEAF					
LAMISTONE CPL	"70"- "70" "80"- "80" "90"- "90" "100"- "100"				
LAMINATED CPL 0.2 mm	"70"- "70" "80"- "80" "90"- "90" "100"- "100"				
LAMINATED CPL 0.5 mm	"70"- "70" "80"- "80" "90"- "90" "100"- "100"				
LAMINATED CPL 0.7 mm	"70"- "70" "80"- "80" "90"- "90" "100"- "100"				

door leaves designed for the DECO INVEST fixed and adjustable metal door frame



- BMD 4 porthole



stainless steel profile

DECO INVEST DOUBLE-LEAF DOOR (mechanical class II) equipped with:

- 6 type T reinforced object hinges (3 hinges per leaf)
- stainless steel shields on the hinge side
- stainless steel shields on the lock side (active leaf)
- shields on the strike side with holes for shootbolt (passive leaf)
- FD12 fixed metal door frame

DOOR DIMENSIONS

DECO INVEST (ZO) adjustable metal door frame:

single-leaf door:
max. width: "110" - 1220 mm, max. height 2278 mm
double-leaf door:
max. width: "100+100" - 2155 mm, max. height 2278 mm

DECO INVEST (FD12) fixed metal door frame:

single-leaf door:
max. width: "110" - 1200 mm, max. height 2268 mm
double-leaf door:
max. width: "100+100" - 2135 mm, max. height 2268 mm

DOOR LEAF FINISH

Plain surface covered with the CPL 0.15 laminate (LAMISTONE);
CPL 0.2; CPL 0.5; CPL 0.7 or 0.8 mm thick HPL. 0.8mm.

GLAZINGS

Transparent or matt 4 mm tempered glass pane.

DOOR FRAMES

Door frame standard powder-coated in the colour of white (RAL 9016, 9003), grey (RAL 7047), brown (RAL 8014), beige (RAL 1001) and graphite (RAL 7024).

FD12 fixed metal door frame made of 1.5 mm thick steel sheet with rabbet seal.

Adjustable metal door frame made of 1.5 mm thick steel sheet (at an extra charge).

ACCESSORIES AND EQUIP- MENT

Standard equipment:

- mortise lock with stainless steel face, version WK, WB and WC
- three-element reinforced type T hinges ("70"- "110" - 3 pcs)
- reinforcement for door closer
- stainless steel protector of the door leaf edge (the lock side and the hinge side)

Additional equipment:

- surface-mounted door closer
- stainless steel grill
- roller lock, stainless steel pull handrail
- stainless steel panels glued to the door leaf bottom or at the handle height
- additional type T hinge - **7**
- version 01, 02, 03: stainless steel spacer

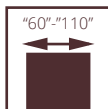

90 PLUS
WIDTH
FOR PUBLIC
UTILITY
BUILDINGS



DOOR LEAVES

mechanical class III with board structure

IN CASE OF DOOR LEAVES FOR METAL DOOR FRAMES MANUFACTURED BY POL-SKONE, HINGES ARE INCLUDED IN THE DOOR FRAME PRICE.

IN CASE OF DOOR LEAVES FOR METAL DOOR FRAMES BY OTHER MANUFACTURERS, DOOR LEAF HINGES ARE AVAILABLE AT AN EXTRA CHARGE.

In POL-SKONE leaves with a metal door frame and a door closer, type T hinges ("60"-80"- 3 pcs, "90"-110"- 4 pcs) are used as a standard.

The door is intended for use in public utility buildings with heavy traffic and in industrial and storage buildings as an interior door closing an opening in an interior wall between rooms. Particularly recommended for schools, kindergartens and hospitals.

The leaf is built of a **wooden frame** reinforced with two vertical strips connected with plywood and an enlarged lower rail and stile set; the in-fill is made of perforated chipboard.

- class 3 mechanical strength i.e. heavy service conditions according to PN-EN 1192:2001
- National Technical Assessment ITB-KOT-2021/2041 issue 1

interior door with board structure, mechanical class III, 00 pattern, DIN adjustable frame



interior door with board structure, mechanical class III, 00 pattern, DIN adjustable frame



DOOR LEAVES FOR METAL DOOR FRAME, WOODEN DOOR FRAME, DIN ADJUSTABLE DOOR FRAME CLASS III



VERSION	00	02	03SD	04	05
PAINTED					
LAMISTONE CPL					
UNI MAT PLUS					
LAMINATED CPL 0.2 mm					
SILKSTONE					
SILKSTONE CPL 0.5 mm					
VENEERED GROUP A					
VENEERED GROUP B					
VENEERED GROUP C, D					
PAINTED – grey, beige					
PAINTED - black, sage					

Door leaf equipped with 3 pcs of hinges: type C (for wooden door frame), type K (for DIN adjustable door frame, III mechanical class), type T (for metal door frame); optionally: DIN door frame, mechanical class III with reinforcement for strike plate in form of pine strip; angular strike plate - extra charge **+10%** added to the DIN adjustable door price

EXTRA CHARGE FOR LAMINATED GLASS INSTEAD OF TEMPERED GLASS IN DOOR LEAVES OF MECHANICAL CLASS III

MATT - WHITE MATT LAMINATED VSG 22.1 GLASS PANE

price [1 glass pane]

white matt

transparent

- door leaf, mechanical class III, 03SD pattern, width "60"-80"
- door leaf, mechanical class III, 03SD pattern, width "90"-100"
- door leaf, mechanical class III, 04SD pattern
- door leaf, mechanical class III, 02SM pattern, width "60"-80"
- door leaf, mechanical class III, 02SM pattern, width "90"-100"

DOOR DIMENSIONS

Wooden fixed door frame:

max. width "110" – 1189 mm, max. height 2264 mm

Wooden adjustable door frame:

max. width "110" – 1195 mm, max. height 2267 mm

DIN system system adjustable door frame mechanical class III:

max. width "100" – 1046 mm, max. height 2243 mm

Fixed metal FD12, FD14 door frame

max. width "110" – 1197 mm, max. height 2268 mm

Metal adjustable door frame:

max. width "110" – 1217 mm, max. height 2278 mm

DOOR LEAF FINISH

Plain surface painted, veneered, covered with CPL laminate with a thickness of 0.2 to 0.7 mm, HPL laminate with a thickness of 0.7 to 1 mm or wood-alike foil.

GLAZINGS

Tempered 4 mm or laminated 22.1 glass pane.

DOOR FRAMES

Door frame painted, veneered, covered with CPL 0.15 mm laminate or wood look-alike foil matched to the colour of the door leaf.

Fixed wooden pine door frame optionally with masking mouldings, quarter round.

Wooden adjustable door frame with widening panels and angular architraves

Adjustable DIN mechanical class III door frame made of 22 mm thick MDF boards with special reinforcement for a strike plate in the form of a pine strip, angular strike plate.

FD12 fixed metal door frame made of 1.5 mm thick steel sheet, **FD14 fixed metal door frame** made of 1.5 mm thick steel sheet; standard powder-coated in the colour of white (RAL 9016, 9003); grey (RAL 7047), brown (RAL 8014), beige (RAL 1001), graphite (RAL 7024) and black (RAL 9005).

Adjustable metal door frame made of 1.5 mm thick steel sheet; standard powder-coated in the colour of white (RAL 9016, 9003), grey (RAL 7047), brown (RAL 8014), beige (RAL 1001), graphite (RAL 7024) and black (RAL 9005); it consists of a major part and an angular architrave that is slid into the major part.

ACCESSORIES AND EQUIPMENT

Standard equipment:

Door with wooden door frame

- 3 type C pivot hinges adjustable in third planes
- latch-and-deadbolt lock for cylinder or key

Door with DIN system door frame, mechanical class III:

- 3 adjustable type K pivot hinges or optionally 3 type T three-part hinges
- latch-and-deadbolt lock for cylinder or key

Door with metal door frame

- 3 type T three-part hinges
- latch-and-deadbolt lock for cylinder or key

standard equipment:

- surface-mounted door closer
- additional mortise or surface-mounted lock
- electric NC or NO strike
- electromagnetic lock
- TYPE T hinge (1 piece)
- DIN mechanical class III door frame - extra charge **+10%** to the DIN adjustable door frame price
- width "100" **+10%**
- width "110" **+20%**
- drop seal
- ventilation undercut - p. 245

CAMBIO DOOR LEAVES WITH PICTOGRAM

CAMBIO DOOR LEAVES, 00 PATTERN WITH PICTOGRAMS

price per piece

00 pattern with pictogram A pattern, B pattern, C pattern, D pattern colour RAL 9003

other colours acc. to the table of extra charges

p. 264

one-sided pictogram, always on the hinge side

WOMEN A



MEN B



DISABLED C



MOTHER WITH CHILD D



STAINLESS STEEL PANEL WITH ICONS

STAINLESS STEEL PANEL WITH ICONS

price per piece

STAINLESS BRUSHED STEEL 1.5 MM THICK, 150 MM WIDE PANEL WITH ICONS

The panel is available with one, two or three icons presented in the photograph.



ALUMINIUM DECORS

colour: chrome matt, black

ALU DECORS FOR FIRE DOORS, CERBER PLUS, B-30, C-30, RC3, CERBER PLUS RC2 (decor ends rounded)

W01

W02

W03

W05

W07

W08

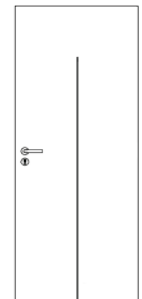
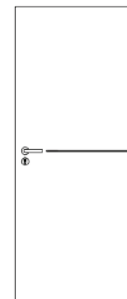
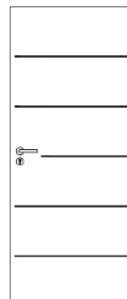
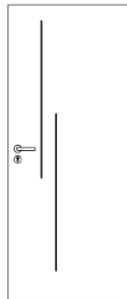
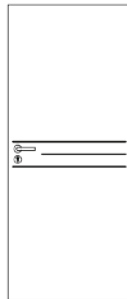
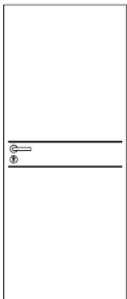

ALUMINIUM MOULDINGS FOR FIRE DOORS, CERBER PLUS, CERBER PLUS RC2, B-30, C-30, RC3 (moulding tips have straight endings, flush with the door leaf edge) (except the painted ones)

W1

W2

W3

W4

W5

W6

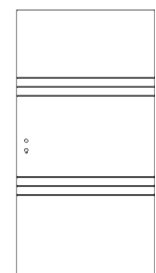
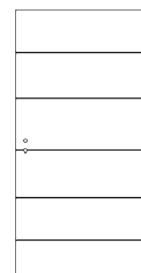
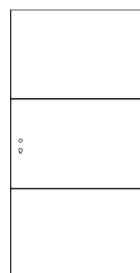
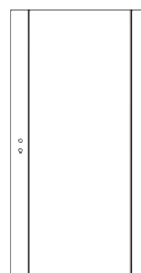
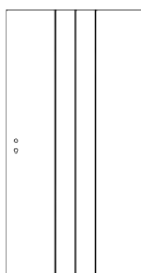
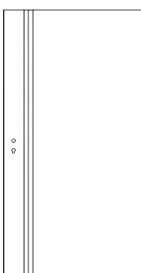

ADDITIONAL EQUIPMENT

STAINLESS STEEL, THICKNESS: 0.6 MM THICK, FOR FIRE DOOR EI30, EI30 PLUS, EI60 PLUS (1 COMPLETE SET)

width "60" width "70" width "80" width "90" width "100" width "110" width "120"

variant A: polished or brushed steel

STAINLESS STEEL, THICKNESS: 0.6 MM THICK, FOR INTERIOR DOOR (1 COMPLETE SET)

variant A: polished or brushed steel

variant B,C,D: polished or brushed steel

variant E,F,G,H: polished or brushed steel

variant I: polished or brushed steel

variant J: polished or brushed steel

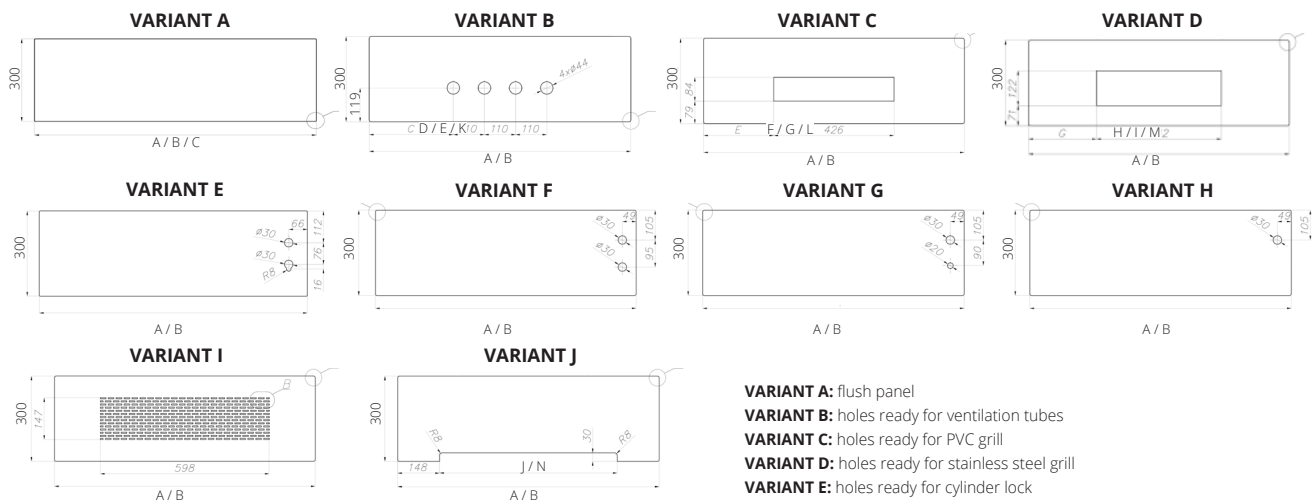

- VARIANT A:** flush panel
- VARIANT B:** holes ready for ventilation tubes
- VARIANT C:** holes ready for PVC grill
- VARIANT D:** holes ready for stainless steel grill
- VARIANT E:** holes ready for cylinder lock
- VARIANT F:** holes ready for one-key system lock
- VARIANT G:** holes ready for WC lock
- VARIANT H:** holes ready for "small lock"
- VARIANT I:** panel with ventilation holes
- VARIANT J:** panel for door leaves with ventilation undercut

- **POLISHED OR BRUSHED STEEL PANELS**
- **PANEL EDGES BLUNTED**
- **PANEL CORNERS ROUNDED - RADIUS 4x R3**

DIMENSIONS: INTERIOR

VARIANT A (REBATED)				VARIANT B, C, D, E, F, G, H, I (REBATED)									
width	A	B	C	width	A	B	D	E	F	G	H	I	J
"30"	-	-	329	"60"*	642	616	156	143	108	95	100	87	506
"40"	-	-	429	"70"	742	716	206	193	158	145	150	137	606
"50"	-	-	529	"80"	842	816	256	243	208	195	200	187	706
"60"	642	616	629	"90"	942	916	306	293	258	245	250	237	806
"70"	742	716	729	"90 plus"	952	926	311	298	263	250	255	242	816
"80"	842	816	829	"100"	1042	1016	356	343	308	295	300	287	906
"90"	942	916	929	"110"	1142	1116	406	393	358	345	350	337	1006
"90 plus"	952	926	-	"120"	1242	1216	456	443	408	395	400	387	1106
"100"	1042	1016	1029										
"110"	1142	1116	-										

- A** panel on the flange side (hinge side)
- B** panel on rabbet side (the side opposite the hinge side)
- C** panel on flange side (hinge side), rabbet side (the side opposite the hinge side) - applies to the passive door leaf (in double-leaf door)
- D** distance of the ventilation tube hole from the door leaf edge (hinge side)
- E** distance of the PVC grill from the door leaf edge (hinge side)
- F** distance of the grill from the door leaf edge (hinge side)
- G** distance of the PVC grill from the door leaf edge (the side opposite the hinge side)
- H** distance of the grill from the door leaf edge (the side opposite the hinge side)
- I** distance of the grill from the door leaf edge (the side opposite the hinge side)
- J** ventilation undercut width

* except VARIANT I

DIMENSIONS: INTERIOR

VARIANT A, B, C, D, E, F, H, I (NON-REBATED)					
width	A	K	L	M	N
"60"*	623	146.5	98.5	90.5	327
"70"	723	196.5	178.5	140.5	427
"80"	823	246.5	198.5	190.5	527
"90"	923	296.5	248.5	240.5	627
"90 plus"	948	309	261	253	657
"100"	1023	346.5	298.5	290.5	727
"110"	1123	396.5	348.5	340.5	827
"120"	1223	446.5	398.5	390.5	927

- A** panel width
- K** distance of the ventilation tube hole from the door leaf edge
- L** distance of the PVC grill from the door leaf edge
- M** distance of the grill from the door leaf edge
- N** ventilation undercut width
- * except VARIANT I

DIMENSIONS: REBATED EI30, EI30 PLUS, EI60 PLUS

DIMENSIONS A, E (REBATED EI30, EI30 PLUS, EI60 PLUS)			
width	A	B	C
"30"	-	-	334
"40"	-	-	434
"50"	-	-	534
"60"	646	622	634
"70"	746	722	734
"80"	846	822	834
"90"	946	922	934
"90 plus"	966	942	-
"100"	1046	1022	1034
"110"	1146	1122	1134

- A** panel on the flange side (hinge side)
- B** panel on rabbet side (the side opposite the hinge side)
- C** panel on flange side (hinge side), rabbet side (the side opposite the hinge side) - applies to the passive door leaf (in double-leaf door)

ADDITIONAL EQUIPMENT

STAINLESS STEEL HINGES [REBATED SYSTEM]

price per piece

Hinge type

metal interior door frame	OTLAV three-part OT-CI335-150IM02
DIN rebated door frame	OTLAV three-part OT-CI335-150IM04
fire EI30 Plus, EI60 Plus with metal door frame	ECO SCHULTE OBX-3011-3D (pocket) ECO SCHULTE OBX-18-1531/120 (hinge)
	extra charge required for pre-milling for hinge
fire EI30 Plus, EI60 Plus with wooden door frame	ECO SCHULTE OBX-3101-3D (pocket) ECO SCHULTE OBX-3199 (shield)
EI30 POL-SKONE system escape	ECO SCHULTE OBX-18-1531/120 (hinge)

Door type	force	Surface-mounted door closers	Hidden door closer
RC4, RC4 EI30	4	GEZE TS 2000, GROOM 200, DORMA TS 83, DORMA TS 92, DORMA TS 93, GEZE TS 3000, GEZE TS 5000	-
B-30, C-30, RC3, SR 37 dB	4	GEZE TS 2000, GEZE TS 3000, GROOM 200, DORMA TS 83	BOXER 2-4, ITS 420 2-4, ITS 96 2-4
FR EI30	4	GEZE TS 2000, GEZE TS 3000, GEZE TS 4000, GROOM 200, DORMA TS 83, DORMA TS 93	BOXER 2-4, ITS 420 2-4, ITS 96 2-4
FR EI30 SR 42 dB, AKUSTIK 42 dB	4	GEZE TS 2000, GEZE TS 3000, GEZE TS 4000, GROOM 200, DORMA TS 83, DORMA TS 93	BOXER 2-4, ITS 96 2-4
EI30 PLUS flush height up to 2200 mm	4*	GEZE TS 2000*, GEZE TS 3000, GEZE TS 4000*, GROOM 200*, DORMA TS 83*	BOXER 2-4, ITS 420 2-4, ITS 96 2-4
EI30 PLUS flush height from 2201 mm up to 2500 mm	5	GEZE TS 2000, GROOM 200, DORMA TS 83, DORMA TS 93	-
EI30 PLUS glazed height up to 2200 mm	5	GEZE TS 2000, GROOM 200, DORMA TS 83, DORMA TS 93	-
EI30 PLUS glazed height from 2201 mm to 2500 mm	6	GEZE TS 4000, GEZE TS 5000, DORMA TS 83, DORMA TS 93	-
EI60 PLUS flush height up to 2200 mm	5	GEZE TS 2000, GROOM 200, DORMA TS 83, DORMA TS 93	BOXER 2-4 *** ITS 420 2-4 *** ITS 96 3-6
EI60 PLUS flush height from 2201 mm to 2500 mm	6	GEZE TS 4000, GEZE TS 5000, DORMA TS 83, DORMA TS 93	ITS 96 3-6
EI60 PLUS glazed height up to 2400 mm	6**	GEZE TS 4000, GEZE TS 5000, DORMA TS 83**, DORMA TS 93**	ITS 96 3-6
EI60 PLUS glazed height from 2401 mm to 2500 mm	7	DORMA TS 83, DORMA TS 93	-
soundproof door TYPE A, TYPE B	4*	GEZE TS 2000*, GEZE TS 3000, GEZE TS 4000*, GROOM 200, DORMA TS 83	-
soundproof door TYPE A DUO, TYPE B DUO	4*	GEZE TS 2000, GEZE TS 3000, GEZE TS 4000, GROOM 200, DORMA TS 83	BOXER 2-4 **** ITS 420 2-4, ITS 96 2-4
interior	4*	GEZE TS 2000*, GEZE TS 3000, GEZE TS 4000*, GROOM 200, DORMA TS 83	GEZE BOXER 2-4 with rail****, ASSA ABLOY DC840 with rail G892

Arm door closers: GEZE TS 2000, GROOM 200, DORMA TS 83, GEZE TS 4000 Rail door closers: GEZE TS 3000, DORMA TS 93, GEZE TS 5000

* for a "110" mm wide door leaf: size 5 door closer

* for a "110" mm wide door leaf: size 7 door closer

*** only for the 1012x2075 mm size door

**** only with fixed door frame

***** door leaf thickness 46 mm, only applicable to rebated door

SPECIFICATION OF HINGES

Door type	Notes	Number of hinges	Type of hinges
TYPE A / TYPE B	-	3	ø13.5 pivot hinge
TYPE A / TYPE B DUO	for widths from "60" to "70"	2	DUO hidden hinge
	for widths from "80"	3	
	for extended doors	3	
DECO INVEST	-	3	three-part T type hinge
HIGRO	-	2	TECTUS by Simonswerk
GAMMA	for widths from "60" to "110"	3	ECO SCHULTE OBX hinge
SR 37 dB	for widths from "60" to "90 PLUS"	3	ø20 pivot hinge
	for width "100"	4	
RC3, RC3 INVEST	-	4	ø16 pivot hinge
RC4	-	2	ECO SCHULTE OBX hinge
RC4 EI30	-	3	ECO SCHULTE OBX hinge
CERBER PLUS, CERBER PLUS RC2	-	3	ø16 pivot hinge
	for widths from "60" to "90 PLUS"	3	
	for width "100"	4	
B-30	for extended doors	4	ø20 pivot hinge
	for widths from "60" to "90 PLUS"	3	
	for width "100"	4	
C-30	for extended doors	4	ø20 pivot hinge
	for widths from "60" to "90 PLUS"	3	
	for width "100"	4	
FR EI30 SR 32 dB	for widths from "60" to "90 PLUS"	3	ø20 pivot hinge
	for width "100"	4	
	for extended doors	4	
FR EI30 SR 42 dB DM, AKUSTIK 42 dB	-	2	ECO SCHULTE OBX hinge
EI30 PLUS	for widths from "60" to "90 PLUS"	3	ø20 pivot hinge
	for widths from "100", "110"	4	
	for doors extended over 25mm	4	
EI30 PLUS rebated version	-	3	ECO SCHULTE/TECTUS by Simonswerk
EI60 PLUS	-	4	ø20 pivot hinge
EI30 PLUS non-rebated version	-	3	ECO SCHULTE/TECTUS by Simonswerk
FR EI30 SR 42	for widths from "60" to "100"	2	ECO SCHULTE OBX hinge
	for width "110"	3	ECO SCHULTE OBX hinge

ADDITIONAL EQUIPMENT

HIDDEN AND OBJECT HINGES [NON-REBATED SYSTEM] FOR FIRE DOOR WITH METAL DOOR FRAME

door	width "60"-90" x height 2000 mm	width "100" x height 2000 mm	width "110" x height 2000 mm
EI30 PLUS	3 pcs of TECTUS hinges by Simonswerk TE 340 3D FR	3 pcs of TECTUS hinges by Simonswerk TE 340 3D FR	3 pcs of TECTUS hinges by Simonswerk TE 540 3D FR
EI60 PLUS	3 pcs of TECTUS hinges by Simonswerk TE 540 3D FR	3 pcs of TECTUS hinges by Simonswerk TE 540 3D FR	3 pcs of TECTUS hinges by Simonswerk TE 540 3D FR

HIDDEN HINGES [NON-REBATED SYSTEM] FOR FIRE DOOR WITH WOODEN DOOR FRAME

door	width "60"-90" x height 2000 mm	width "100" x height 2000 mm	width "110" x height 2000 mm
EI30 PLUS	3 pcs of TECTUS hinges by Simonswerk TE 340 3D FR	3 pcs of TECTUS hinges by Simonswerk TE 340 3D FR	3 pcs of TECTUS hinges by Simonswerk TE 540 3D FR
EI60 PLUS	3 pcs of TECTUS hinges by Simonswerk TE 540 3D FR	3 pcs of TECTUS hinges by Simonswerk TE 540 3D FR	3 pcs of TECTUS hinges by Simonswerk TE 540 3D FR

PANIC BAR FOR SINGLE-LEAF DOOR (ESCAPE, FIRE AND INTERIOR DOOR) WITH SINGLE-POINT LOCKING.

PHA 2102 panic bar for fire door
 PHA 2104 panic bar rod for fire door (for a max. 1000 mm wide door leaf)
 PHA 2105 panic bar rod for fire door (for a max. 1300 mm wide door leaf)
 PHA 3905 panic handle with spindle for fire door
 class A asymmetrical cylinder, silver 9/31 standard
 bar latch, latch 1 piece

PANIC BAR FOR SINGLE-LEAF (FIRE) DOOR WITH THREE-POINT LOCKING SYSTEM

PHA 2102 panic bar for fire door
 PHA 2104 panic bar rod for fire door (for a max. 1000 mm wide door leaf)
 PHA 2105 panic bar rod for fire door (for a max. 1300 mm wide door leaf)
 PHA 3905 panic handle with spindle for fire door
 PHX 04 vertical rods with shield (for a 2270 mm height door leaf)
 PHX 05 vertical rods with shield (for a 3400 mm height door leaf)
 PHX 03 vertical door bolts with latches
 class A asymmetrical cylinder, silver 9/31 standard
 bar latch, latch 2 piece

PANIC BAR FOR DOUBLE-LEAF DOOR (ESCAPE, FIRE AND INTERIOR DOOR) WITH THREE-POINT LOCKING

PHA 2102 panic bar for fire door - 2 pcs
 PHA 2104 panic bar rod for fire door (for a max. 1000 mm wide door leaf) - 2 pcs
 PHA 2105 panic bar rod for fire door (for a max. 1300 mm wide door leaf) - 2 pcs
 PHA 3905 panic handle with spindle for fire door
 PHX 04 vertical rods with shield (for a 2270 mm height door leaf)
 PHX 05 vertical rods with shield (for a 3400 mm height door leaf)
 PHX 03 vertical door bolts with latches
 class A asymmetrical cylinder, silver 9/31 standard
 bar latch, latch 1 piece

AUXILIARY EQUIPMENT

600 ALH EMC lock
 reinforcement for EMC lock for DIN door frame
 reinforcement for EMC lock for steel door frame
 Mounting component - L+Z racket for EMC 600 ALH (mounting are selected depending on the EMC lock installation method)
 Mounting component for AMF 600 fire door for 600 ALH EMC lock
 MC 250 mortise reed switch
 MC200-S19 mounting flange for reed switch (white colour) (for metal door frames):
 stainless steel pull handrail for DECO INVEST door (double-sided, length 900 mm, d=25)
 roller lock, version with cylinder for the DECO INVEST door (version WK, WC)
 ABLOY EL560/EI 561 lock (lock + shield (cable routing) EA 281 + kabel EA 218)*
 ABLOY EL560/EI 561 lock (lock + shield (cable routing) EA 280 + kabel EA 218)*
 * extra charge for milling for lock

ADDITIONAL EQUIPMENT

FIRE PROTECTION HANDLES FOR THE E130 SR32, E130 PLUS, SR 37 DOORS

Handle 903.92.276 (spindle: 8 mm square, length 100 mm, stud length 60 mm) + rose WB
 Handle 903.92.076 (spindle: 8 mm square, length 100 mm, stud length 60 mm) + rose WB
 Handle 903.92.154 (spindle: 8 mm square, length 100 mm, stud length 60 mm) + WB rose



903.92. 276



903.92. 076



903.92. 154

FIRE PROTECTION HANDLES FOR THE E130 SR42, E160 PLUS DOOR

Handle 903.92.276 (spindle: 8 mm square, length 100 mm, stud length 70 mm) + WB rose
 Handle 903.92.076 (spindle: 8 mm square, length 100 mm, stud length 70 mm) + WB rose
 Handle 903.92.154 (spindle: 8 mm square, length 100 mm, stud length 70 mm) + WB rose

FIRE PORTHOLE FOR E130 PLUS, E160 PLUS DOOR

fire porthole for E130 PLUS door (Ø 320 mm)
 fire porthole for E160 PLUS door (Ø 320 mm)

FIRE PROTECTION GRILL FOR E130 PLUS, E160 PLUS DOOR

GRILL DIMENSIONS [MM]
 500 x 150
 300 x 150

HINGE CAPS FOR E160 PLUS, E130 PLUS B-30, C-30, FR E130 DOORS (WOODEN DOOR FRAME)

PVC dia. 20 mm cap white, brown, black
 PVC dia. 20 mm cap chrome matt, nickel matt

HINGE CAPS FOR RC3, CERBER PLUS, CERBER PLUS RC2 DOORS (WOODEN DOOR FRAME)

PVC dia. 16 mm cap white, brown, black
 PVC dia. 16 mm cap chrome matt, nickel matt

HIDDEN DOOR CLOSERS

ITS 96 (2-4) DORMA WITH RAIL (silver colour)
 ("easy open" aided opening function, opening limiter)
 ITS 420 2-4 WITH RAIL
 ITS 96 (3-6) DORMA WITH RAIL (silver colour)
 ("easy open" aided opening function, opening limiter)

GEZE BOXER 2-4 (silver colour)
 GEZE BOXER 3-6 (silver colour)
 GEZE BOXER 3-6 (colour RAL 9005)
 GEZE BOXER 2-4 with an electromechanical opening lock

GEZE BOXER 2-4 (**colour RAL 9005**)
 body in the silver colour, rail in the colour of RAL 9005

ITS 96 (2-4) DORMA WITH RAIL **IN THE COLOUR OF RAL 9005**
 ("easy open" aided opening function, opening limiter)
 ITS 96 (3-6) DORMA WITH RAIL **IN THE COLOUR OF RAL 9005**
 ("easy open" aided opening function, opening limiter)
 milling for door closer
 opening limiter for GEZE BOXER door closer

surface-mounted DOOR CLOSERS GEZE, DORMA/GROOM

Door closer TS 2000 NV (2-4) with arm (silver colour)
 Door closer TS 3000 (1-4) with rail and mounting plate
 Door closer TS 4000 (1-6) with arm (silver colour)
 opening angle lock RF G-N for door closer TS 93B
 Door closer GROOM GR 200 (2-5)
 Door closer TS 83 (3-6) with arm
 ASSA 2396 semi-automatic shootbolts for door with door closer with closing sequence control (for 1 piece of double-leaf door)

Door closer TS 2000 NV with arm
(black colour RAL 9005)
 Door closer TS 3000 with rail and mounting plate
(black colour RAL 9005)
 Door closer TS 4000 with arm
(black colour RAL 9005)
 Door closer TS 5000 (2-6) with rail and mounting plate
(black colour RAL 9005)
 Door closer TS 91 (4) with rail
 ("easy open" aided opening function)
 Door closer Z TS 93B (2-5) with rail
 ("easy open" aided opening function)

Closing sequence control must be used for double-leaf fire door since it is required to keep fire door permanently closed in the event of fire. The closing sequence control can be used in double-leaf fire doors with a wooden or metal door frame and in double-leaf interior doors with an adjustable DIN system or metal frame. The minimum width of the double-leaf door at which the closing sequence control system can be used is "90+40". In the case of doors with a passive leaf with a width of "30", a door closer cannot be installed. If the door is equipped with manually slid shootbolts, it is required to obtain an appraisal by a fire protection expert who will analyse the specific situation and give an approval of such solution for the building in question.

Set of door closers with closing sequence control (the price includes 2 pcs of surface-mounted door closer TS93B and rail GSR V). Fire door must be equipped with ASSA 2396 automatic shootbolts or a panic bar with a three-point locking system.

Interior doors must be fitted with a panic lever with three-point bolt locking system. In addition, if the door is to be kept permanently open, it must be equipped with electromagnetic holders.

GTR 048 by DORMAKABA

GTR 048 by DORMAKABA suitable for fixing the holder to the floor; it is necessary to optionally order the angle bar. Complete set holder + angle bar

HARMONY DOOR FRAME (RAW, FOR DO-IT-YOURSELF PAINTING) COMPATIBLE WITH ELECTRIC STRIKE

DOOR FRAME WITH NC ELECTRIC STRIKE
 "60"- "80" x 2040/2050 mm
 "90"- "100" x 2040/2050 mm
 "60"- "100" x 2140/2150 mm
 "60"- "100" x 2240/2250 mm
 "60"- "100" x 2340/2350 mm
 "60"- "100" x 2440/2450 mm

DOOR FRAME WITH NO ELECTRIC STRIKE
 "60"- "80" x 2040/2050 mm
 "90"- "100" x 2040/2050 mm
 "60"- "100" x 2140/2150 mm
 "60"- "100" x 2240/2250 mm
 "60"- "100" x 2340/2350 mm
 "60"- "100" x 2440/2450 mm

ELECTRIC STRIKES FOR METAL DOOR FRAME FOR THE RC3 DOOR

symmetrical BIRA electric strike 12V AC/DC standard
 symmetrical BIRA electric strike 12V AC/DC including mem.
 symmetrical BIRA electric strike 24V AC/DC standard
 symmetrical BIRA electric strike 24V AC/DC including mem.
 symmetrical BIRA electric strike 12V AC/DC including closing control, standard
 symmetrical BIRA electric strike 12V AC/DC including closing control, with mem.
 symmetrical low-voltage BIRA electric strike 24 V DC including closing control and varistor, standard
 symmetrical low-voltage BIRA electric strike 24 V DC including closing control and varistor, including mem.
 metal door frame reinforcement RC3 for electric strike

ADDITIONAL EQUIPMENT

ELECTRIC NC STRIKE IN THE HALSPAN SYSTEM EI30 PLUS DOUBLE-LEAF FIRE DOOR (INCLUDING: ELECTRIC STRIKE + STRIKE PLATE + CABLE + CABLE ROUTING)

HARTTE SHD12U electric strike (12V AC/DC)
HARTTE SHD24U electric strike (24V AC/DC)
JIS 1710 electric strike 12-24 AC/DC
JIS 1733-12AC/DC electric strike (including built-in memory)
JIS 1733-24AC/DC electric strike (including built-in memory)
*series SHD - other models of electric strikes available subject to consultation with the Sales Department
Electric strike EFF-EFF 118F.14-----A71 (10-24V AC/DC)
Electric strike plate (11F35-04 or 11F35-05) – for rebated door
Fire 447 electric strike 6-12V AC/DC
Electric strike Fire 447 12V DC 100% ED*
Electric strike Fire 447 24V DC 100% ED*
Electric strike plate FL 22
* non-heating electric strike
Cable EFF-EFF 760-250-00
Cable routing EA 281

ELECTRIC NC STRIKE IN THE HALSPAN SYSTEM EI30 AND EI60 PLUS DOUBLE-LEAF FIRE DOOR (INCLUDING: ELECTRIC STRIKE + STRIKE PLATE + CABLE + CABLE ROUTING)

HARTTE SHD12U electric strike (12V AC/DC)
HARTTE SHD24U electric strike (24V AC/DC)
Electric strike plate FL 22
*series SHD - other models of electric strikes available subject to consultation with the Sales Department
Electric strike EFF-EFF 118F.14-----A71 (10-24V AC/DC)
Electric strike plate (11F35-04 or 11F35-05) – for rebated door (only EI30 door)
Fire 447 electric strike 6-12V AC/DC
Electric strike Fire 447 12V DC 100% ED*
Electric strike Fire 447 24V DC 100% ED*
Electric strike plate FL 22
* non-heating electric strike
Cable EFF-EFF 760-250-00
Cable routing EA 281

HARDWARE FOR SINGLE-LEAF ESCAPE DOORS WITH MORTISE LOCK (FOR EI30, EI60 FIRE DOORS WITH METAL DOOR FRAME) (INCLUDING BAR + ROD + STUD + HANDLE OR KNOB)

PHA 2500 bar, panic function B*
PHA 2500 bar, panic function D*
PHA 2500 bar, panic function E*
PHA 2104 rod (for door leaf with a width of up to 1000 mm)
PHA 2105 rod (for door leaf with a width of up to 1300 mm)
*lock with rounded sheet 20x235 mm, backset 65 mm, right-hand or left-hand
Hardware available in the Silver and stainless steel finish
Split spindle PR 120 FS-53 (for EI30 Plus door)
Split spindle PR 120 FS-60 (for EI60 Plus door)
Handle 8100 with longitudinal backplate 7051 (function B, D) - aluminium finish
Handle 8100 with longitudinal backplate 7051 (function B, D) - stainless steel finish
Spindle PR 115 FS-75 (for EI30 Plus door)
Spindle PR 115 FS-75 (for EI60 Plus door)
Knob 8020 with longitudinal backplate 7051 (function E) - stainless steel finish
Knob 8020 with longitudinal backplate 7051 (function E) - aluminium finish

MORTISE PANIC LOCKS (THE COMPLETE SET INCLUDES LOCK + SPINDLE + HANDLE) FOR TECHNICAL DOORS (FOR EI30, EI30 PLUS, EI60 PLUS FIRE DOORS)

GBS 92 with panic function type B backset 65 lock face plate 24x235
GBS 92 with panic function type E backset 65 lock face plate 24x235
GBS 92 with panic function type D backset 65 lock face plate 24x235
split spindle 9 mm
double-sided handle for door with panic lock:
*handle - handle on oval backplate
*handle - knob on oval backplate

ADDITIONAL EQUIPMENT

MORTISE PANIC LOCKS FOR INTERIOR DOOR (THE SET INCLUDES LOCK + SPINDLE + HANDLE)

- GBS 92 with type B panic function, backset 65 mm, face plate 20x235 mm
- GBS 92 with type D panic function, backset 65 mm, face plate 20x235 mm
- GBS 92 with type E panic function, backset 65 mm, face plate 20x235 mm
- split spindle 9 mm (panic function type D and B)
- handle - handle (panic function type D and B)
- handle - knob (spindle 9 mm, panic function type E)

ELECTRIC NC STRIKE IN THE HALSPAN SYSTEM EI30 PLUS SINGLE-LEAF FIRE DOOR (INCLUDING: ELECTRIC STRIKE + STRIKE PLATE)

- HARTTE SHD12U electric strike (12V AC/DC)
- HARTTE SHD24U electric strike (24V AC/DC)
- JJS 1733-12AC/DC electric strike (including built-in memory)
- JJS 1710 electric strike 12-24 AC/DC
- JJS 1733-24AC/DC electric strike (including built-in memory)
- Electric strike plate SPEC-240 (rebated door)
- Electric strike plate SPEC-251 (non-rebated door)
- *series SHD - other models of electric strikes available subject to consultation with the Sales Department
- Electric strike EFF-EFF 118F.14-----A71 (10-24V AC/DC)
- Electric strike plate (11F35-04 or 11F35-05) - for rebated door (only EI30 door)
- Electric strike Fire 447 6-12V AC/DC
- Electric strike Fire 447 12V DC 100% ED*
- Electric strike Fire 447 24V DC 100% ED*
- Electric strike plate WR 25-R, WL 25-R - for rebated door
- * non-heating electric strike

ELECTRIC NC STRIKE IN THE HALSPAN SYSTEM EI30 AND EI60 PLUS SINGLE-LEAF FIRE DOOR (INCLUDING: ELECTRIC STRIKE + STRIKE PLATE)

- HARTTE SHD12U electric strike (12V AC/DC)
- HARTTE SHD24U electric strike (24V AC/DC)
- Electric strike plate SPEC-240 (rebated door)
- Electric strike plate SPEC-251 (non-rebated door)
- *series SHD - other models of electric strikes available subject to consultation with the Sales Department
- Electric strike EFF-EFF 118F.14-----A71 (10-24V AC/DC) (only EI30 door)
- Electric strike plate (11F35-04 or 11F35-05) - for rebated door (only EI30 door)
- Electric strike Fire 447 6-12V AC/DC
- Electric strike Fire 447 12V DC 100% ED*
- Electric strike Fire 447 24V DC 100% ED*
- Electric strike plate WR 25-R, WL 25-R - for rebated door
- * non-heating electric strike

ELECTRIC NO STRIKE IN EI30, EI30 PLUS, EI60 PLUS SINGLE-LEAF FIRE DOOR (INCLUDING: ELECTRIC STRIKE + STRIKE PLATE + LOCK TVZ -510)

- HARTTE SHD12R electric strike (12V AC/DC)
- HARTTE SHD24R electric strike (24V AC/DC)
- TV-Z 510 lock (Dormakaba)
- Electric strike plate SPEC-250 (rebated door)
- Electric strike plate SPEC-236 (non-rebated door)

ELECTRIC NO STRIKE IN EI30, EI30 PLUS, EI60 PLUS DOUBLE-LEAF FIRE DOOR (INCLUDING: ELECTRIC STRIKE + STRIKE PLATE + TVZ -510 LOCK + CABLE + CABLE ROUTING)

- HARTTE SHD12R electric strike (12V AC/DC)
- HARTTE SHD24R electric strike (24V AC/DC)
- TV-Z 510 lock (Dormakaba)
- Electric strike plate OKU -007
- Cable EFF-EFF 760-250-00
- Cable routing EA 281



PANORAMIC VIEWER

- stainless steel
- brass
- black matt
- anthracite

Viewers:

- interior doors, Cerber Plus: viewer Ø15 LOB with a range of 35-55 mm
- technical door: viewer Ø20 Panorama 200 with a range of 45-70 mm

ELECTRIC STRIKE FOR DECO INVEST DOUBLE-LEAF DOOR price per piece

- electric NC strike 118 + catch plate + cable routing + cable + milling for electric strike
- electric NO strike 138/NO/Profix2/1 + catch plate + cable routing + cable + milling for electric strike

OAK THRESHOLDS FOR DOORS CERBER PLUS, CERBER RC2 B-30, C-30, RC3



black threshold, ALU strip in the colour of black



brown threshold, ALU strip in the colour of black



grey threshold, ALU strip in the colour of silver

- **fixed or adjustable**
- **wooden, steel or MDF**
- **architraves connected at an angle of 45° and 90°**
- **for interior, entrance and technical doors**
- **rebated, hidden, non-rebated, reverse-rebate system**

DOOR FRAMES

The door frame is an essential component of a door set, crucial for its functionality and attractive appearance. The basic criterion that makes door frames vary is their structure which can be either fixed or adjustable.

A well-chosen door frame should fit, both technically - the thickness of the wall - and aesthetically - the style of the interior and the design and colour of the door leaf.







FIXED door frame POL-SKONE

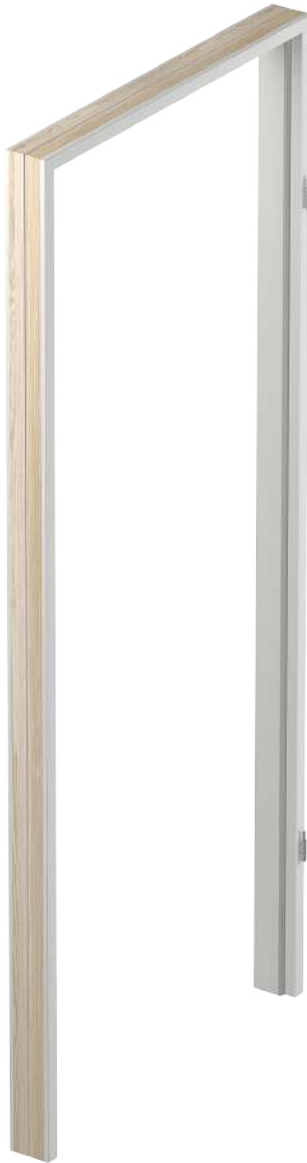

laminated CPL 0.2				VENEERED		
HIGH TOP	PAINTED* white	PAINTED* grey, beige	BLACK black, sage	GROUP A	GROUP B	GROUP C, D
LAMISTONE CPL						
SILKSTONE						
UNI MAT PLUS						

single-leaf door
double-leaf
door

EXTRA CHARGES

door frames lower by 50 mm or 100 mm	without an extra charge
door frames higher by 50 mm or 100 mm	+10%
door frames higher by 150 mm or 200 mm	+20%
"100"	
"110"	
electric NC strike JJS 1710 12-24V AC/DC (including catch plate and milling for the electric strike) **	
electric NC strike BIRA HARTTE XS narrow XS12U 12V AC/DC (including plate and milling for the electric strike)**	
electric NC strike with off-switch BIRA HARTTE XS12UW 12V AC/DC (including catch plate and milling for the electric strike) **	
electric NC strike BIRA HARTTE XS narrow XS12R 12V DC (including plate and milling for the electric strike)**	

EXTRA CHARGE TABLE	GROUP I	GROUP II	GROUP III	GROUP IV	GROUP V
for RAL, NCS door frames acc. to the colour groups*	+20%	+30%	+40%	+60%	+75%

OPTION

LD6 masking strips (at an extra charge)

*environment-friendly acrylic paints, RAL and NCS colours (except metallic ones)
- available at an extra charge according to the colour groups (p. 264)
** for leaves equipped with the ECO Schulte GBS 12 lock

WIDTH

single-leaf door			double-leaf door			
type	S _o	S _d	S _s	type	S _o	S _d
"60"	709	689	618	"60"+"60"	1343	1323
"70"	809	789	718	"60"+"70"	1443	1423
"80"	909	889	818	"60"+"80","70"+"70"	1543	1523
"90"	1009	989	918	"60"+"90","70"+"80"	1643	1623
"90 plus"	1019	999	928	"70"+"90","80"+"80"	1743	1723
				"80"+"90"	1843	1823
				"90"+"90"	1943	1923

HEIGHT

H _o	H _d	H _s
2074	2064	2020

S_s - door leaf width
S_d - door width on the door frame external side
S_o - installation opening width

H_s - door leaf height
H_d - door height on the external side of the door frame
H_o - installation opening height

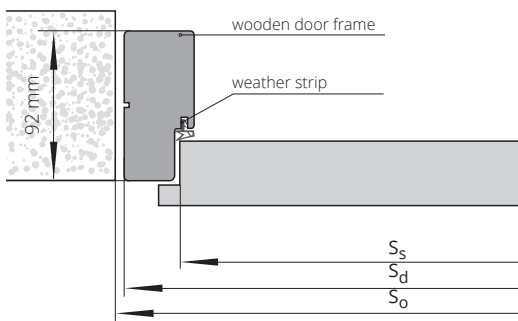



FIXED door frame DUO SYSTEM



laminated CPL 0,2				VENEERED		
HIGH TOP	PAINTED* white	PAINTED* grey, beige	BLACK black, sage	GROUP A	GROUP B	GROUP C, D
LAMISTONE CPL						
SILKSTONE						
UNI MAT PLUS						

single-leaf door

double-leaf
door

EXTRA CHARGES

door frames lower by 55 mm or 100 mm	without an extra charge				
door frames higher by 50 mm or 100 mm	+10%				
door frames higher by 150 mm or 200 mm	+20%				
electric strike BIRA HARTTE XS narrow with tongue guide (NO type) XS12R-C 12V DC (including SPEC-525 strike plate and milling for the electric strike)**					
electric strike BIRA HARTTE XS narrow with tongue guide (NO type) XS12U-C 12V AC/DC (including SPEC-525 strike plate and milling for the electric strike)**					
electric strike BIRA HARTTE XS narrow with tongue guide (NO type) XS12UW-C 12V AC/DC (including SPEC-525 strike plate and milling for the electric strike)**					
EXTRA CHARGE TABLE for RAL, NCS door frames acc. to the colour groups*	GROUP I	GROUP II	GROUP III	GROUP IV	GROUP V
	+20%	+30%	+40%	+60%	+75%

*environment-friendly acrylic paints, RAL and NCS colours (except metallic ones) - available at an extra charge according to the colour groups (p. 264)

** for leaves equipped with the ECO Schulte GBS 12 lock dimension of the mounting hole width increased by additional 25 mm

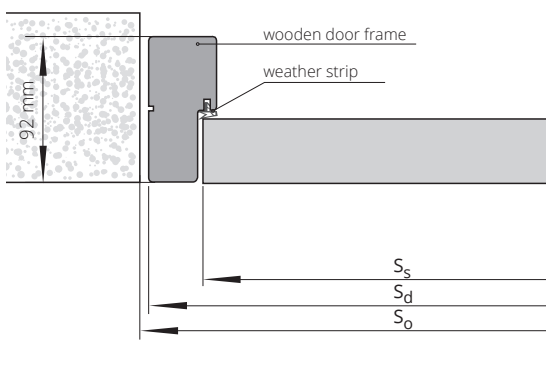

WIDTH						
single-leaf door				double-leaf door		
type	S _o	S _d	S _s	type	S _o	S _d
"60"	713	693	625	"60"+"60"	1328	1308
"70"	813	793	725	"60"+"70"	1428	1408
"80"	913	893	825	"60"+"80", "70"+"70"	1528	1508
"90"	1013	993	925	"60"+"90", "70"+"80"	1628	1608
"90 plus"	1038	1018	950	"70"+"90", "80"+"80"	1728	1708
				"80"+"90"	1828	1808
				"90"+"90"	1928	1908
HEIGHT				H _o	H _d	H _s
				2093	2083	2040

S_s - door leaf width
S_d - door width on the door frame external side
S_o - installation opening width

H_s - door leaf height
H_d - door height on the external side of the door frame
H_o - installation opening height



ADJUSTABLE door frame POL-SKONE SYSTEM



single-leaf door	symbol	range in mm	HIGH TOP	VENEERED		
			UNI MAT PLUS	GROUP A	GROUP B	GROUP C, D
			LAMISTONE CPL			
			SILKSTONE			
			laminated CPL 0.2			
	ZZ1	62-79				
	ZZ2	79-99				
	ZZ3	99-123				
	ZZ4	123-143				
	ZZ5	143-189				
	ZZ6	189-209				
	ZZ7	209-255				
	ZZ8	255-275				
	ZZ9	275-321				
	ZZ10	321-341				
	ZZ11	341-391				

Door frames with ranges wider than the maximum ones provided in the above table are available (upon consultation with the Sales Department).
* for leaves equipped with the ECO Schulte GBS 12 lock architraves are ready milled for electric strike.

EXTRA CHARGES

door frames lower by 50 mm or 100 mm	without an extra charge
door frames higher by 50 mm or 100 mm	+10%
door frames higher by 150 mm or 200 mm	+20%
double-leaf door	+50%
"100"	
"110"	
electric NC strike JIS 1710 12-24V AC/DC (including catch plate and milling for the electric strike)*	
electric NC strike BIRA HARTTE XS narrow XS12U 12V AC/DC (including plate and milling for the electric strike)*	
electric NC strike with off-switch BIRA HARTTE XS12UW 12V AC/DC (including catch plate and milling for the electric strike)*	
electric NC strike BIRA HARTTE XS narrow XS12R 12V DC (including plate and milling for the electric strike)*	

crown p. 248

WIDTH

type	single-leaf door				double-leaf door			
	S _o	S _d	S _s	S _{op}	type	S _o	S _d	S _{op}
"60"	715	695	618	798	"60"+"60"	1350	1330	1433
"70"	815	795	718	898	"60"+"70"	1450	1430	1533
"80"	915	895	818	998	"60"+"80","70"+"70"	1550	1530	1633
"90"	1015	995	918	1098	"60"+"90","70"+"80"	1650	1630	1733
"90 plus"	1025	1005	928	1108	"70"+"90","80"+"80"	1750	1730	1833
					"80"+"90"	1850	1830	1933
					"90"+"90"	1950	1930	2033

HEIGHT

H _o	H _d	H _s	H _{op}
2077	2067	2020	2118

S_s - door leaf width
S_d - door width on the door frame external side
S_o - installation opening width
S_{op} - width on the external side of the architrave

H_s - door leaf height
H_d - door height on the external side of the door frame
H_o - installation opening height
H_{op} - architrave external height

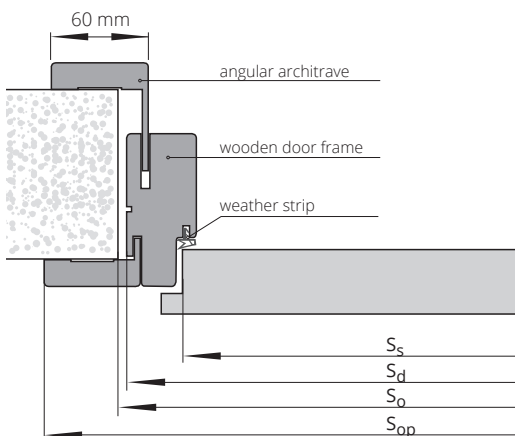



ADJUSTABLE door frame SYSTEM DUO

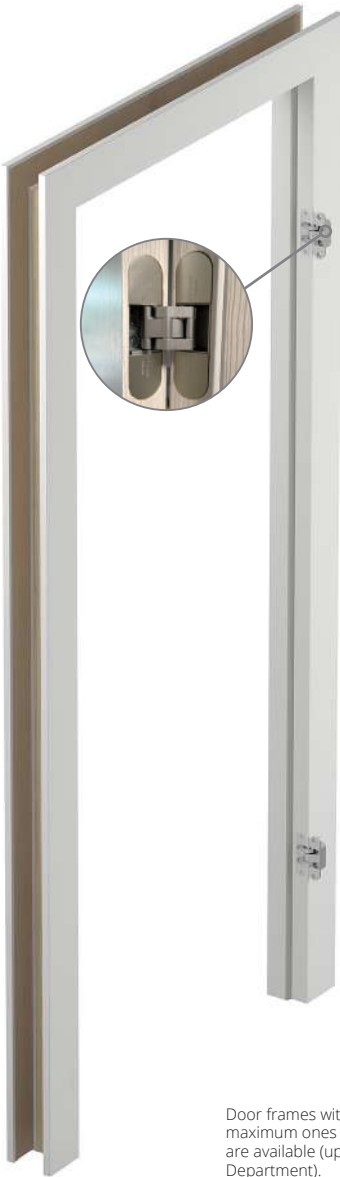

single-leaf
door

symbol	range in mm	HIGH TOP	VENEERED		
		UNI MAT PLUS	GROUP A	GROUP B	GROUP C, D
		LAMISTONE CPL			
		SILKSTONE			
		laminated CPL 0.2			
DI1	76-96				
DI2	96-120				
DI3	120-140				
DI4	140-186				
DI5	186-206				
DI6	206-252				
DI7	252-272				
DI8	272-318				
DI9	318-338				
DI10	338-388				

EXTRA CHARGES

double-leaf door	+50%
door frames lower by 55 mm or 100 mm	without an extra charge
door frames higher by 50 mm or 100 mm	+10%
door frames higher by 150 mm or 200 mm	+20%
"100"	
"110"	
architraves interconnected at 90° angle	
electric strike BIRA HARTTE XS narrow with tongue guide (NO type) XS12R-C 12V DC (including SPEC-525 strike plate and milling for the electric strike)*	
electric strike BIRA HARTTE XS narrow with tongue guide (NO type) XS12U-C 12V AC/DC (including SPEC-525 strike plate and milling for the electric strike)*	
electric strike BIRA HARTTE XS narrow with tongue guide (NO type) XS12UW-C 12V AC/DC (including SPEC-525 strike plate and milling for the electric strike)*	

crown p. 248

WIDTH

type	single-leaf door				double-leaf door			
	S _o	S _d	S _s	S _{op}	type	S _o	S _d	S _{op}
"60"	713	693	625	836	"60"+"60"	1328	1308	1451
"70"	813	793	725	936	"60"+"70"	1428	1408	1551
"80"	913	893	825	1036	"60"+"80","70"+"70"	1528	1508	1651
"90"	1013	993	925	1136	"60"+"90","70"+"80"	1628	1608	1751
"90 plus"	1038	1018	950	1161	"70"+"90","80"+"80"	1728	1708	1851
					"80"+"90"	1828	1808	1951
					"90"+"90"	1928	1908	2051

HEIGHT

H _o	H _d	H _s	H _{op}
2093	2083	2040	2154

S_s - door leaf width
S_d - door width on the door frame external side
S_o - installation opening width
S_{op} - width on the external side of the architrave

H_s - door leaf height
H_d - door height on the external side of the door frame
H_o - installation opening height
H_{op} - architrave external height

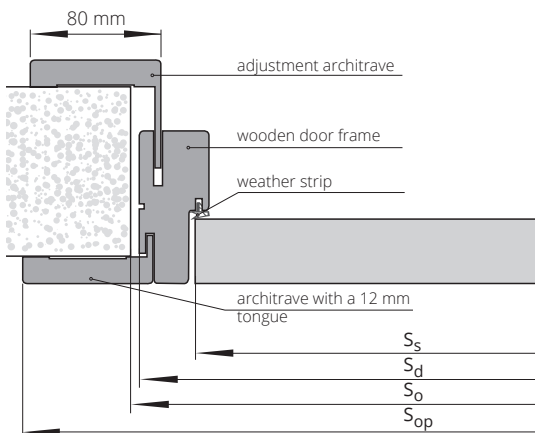

Door frames with ranges wider than the maximum ones provided in the above table are available (upon consultation with the Sales Department).
** for leaves equipped with the ECO Schulte GBS 12 lock



FIXED door frame MDF

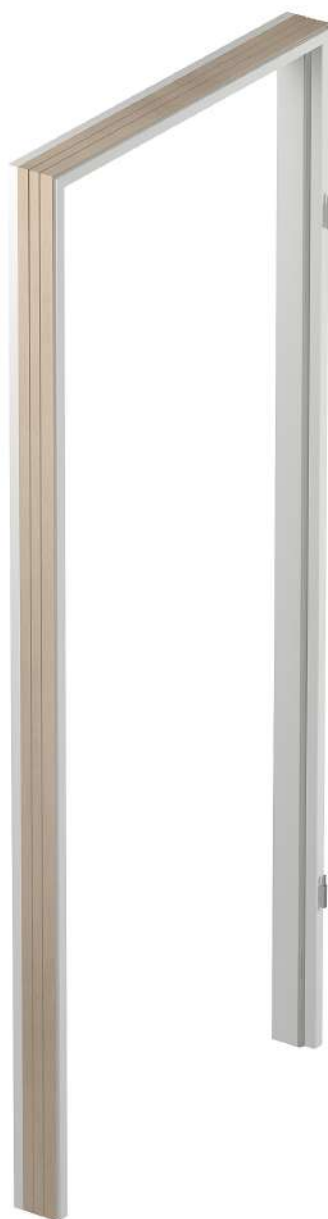

ECO TOP

single-leaf door

EXTRA CHARGES

double-leaf door	+50%
door frames lower by 50 mm or 100 mm	without an extra charge
"100"	
"110"	

OPTION

LD6 masking strips (at an extra charge)

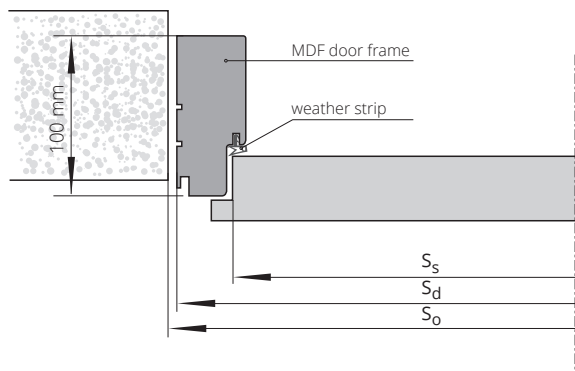

WIDTH

single-leaf door			double-leaf door			
type	S _o	S _d	S _s	type	S _o	S _d
"60"	709	689	618	"60"+"60"	1343	1323
"70"	809	789	718	"60"+"70"	1443	1423
"80"	909	889	818	"60"+"80", "70"+"70"	1543	1523
"90"	1009	989	918	"60"+"90", "70"+"80"	1643	1623
				"70"+"90", "80"+"80"	1743	1723
				"80"+"90"	1843	1823
				"90"+"90"	1943	1923

HEIGHT

	H _o	H _d	H _s
	2074	2064	2020

S_s - door leaf width
S_d - door width on the door frame external side
S_o - installation opening width

H_s - door leaf height
H_d - door height on the external side of the door frame
H_o - installation opening height



ADJUSTABLE door frame DIN SYSTEM



single-leaf door	ECO TOP	HIGH TOP LAMISTONE CPL SILKSTONE UNI MAT PLUS	laminated CPL 0.2	PAINTED* white
	ZP1A	75-85		
	ZP1B	85-95		
	ZP2	95-120		
ZP3	120-140			
ZP4	140-160			
ZP5	160-180			
ZP6	180-200			
ZP7	200-220			
ZP8	220-240			
ZP9	240-260			
ZP10	260-280			
ZP11	280-300			

single-leaf door	PAINTED* grey, beige	BLACK black, sage	VENEERED		
			GROUP A	GROUP B	GROUP C, D
ZP1A	75-85				
ZP1B	85-95				
ZP2	95-120				
ZP3	120-140				
ZP4	140-160				
ZP5	160-180				
ZP6	180-200				
ZP7	200-220				
ZP8	220-240				
ZP9	240-260				
ZP10	260-280				
ZP11	280-300				

EXTRA CHARGES

double-leaf door	+50%
door frames lower by 50 mm or 100 mm	without an extra charge
door frames higher by 50 mm or 100 mm	+10%
door frames higher by 150 mm or 200 mm	+20%
"100"	
"110"	
architraves interconnected at an angle of 90° (version C 90° architrave only)	
architraves with a width of 80 mm	without an extra charge
electric NC strike JIS 1710 12-24V AC/DC (including catch plate and milling for the electric strike)**	
electric NC strike BIRA HARTTE XS narrow XS12U 12V AC/DC (including plate and milling for the electric strike)**	
electric NC strike with off-switch XS12UW 12V AC/DC (including strike plate and milling for the electric strike)**	
electric NC strike BIRA HARTTE XS narrow XS12R 12V DC (including plate and milling for the electric strike)**	
reinforcement for an arm/guide rail door closer***	
replacement of the B type hinge with the K type hinge	
three-part T type hinge	
crown	p. 248

Door frames with ranges wider than the maximum ones provided in the above table are available (upon consultation with the Sales Department).
*environment-friendly acrylic paints, RAL and NCS colours (except metallic ones) – available at an extra charge according to the colour groups (p. 264)
** for leaves equipped with the ECO Schulte GBS 12 lock - extra charge + 12, dimension of the mounting hole width increased by additional 15 mm
***NOTE! The recommended dimension of the installation opening height increased by 16 mm.

new method of connecting architraves – p. 254

Version A: 60 mm (except the painted door)
Version B: 80 mm

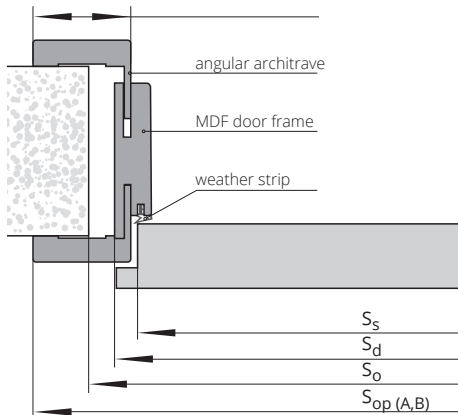

EXTRA CHARGE TABLE for RAL, NCS door frames acc. to the colour groups*	GROUP I	GROUP II	GROUP III	GROUP IV	GROUP V
	+20%	+30%	+40%	+60%	+75%

WIDTH

single-leaf door						double-leaf door				
type	So	Sd	Ss	SopA	SopB	type	So	Sd	SopA	SopB
"60"	676	646	618	748	788	"60"+"60"	1320	1280	1382	1422
"70"	776	746	718	848	888	"60"+"70"	1420	1380	1482	1522
"80"	876	846	818	948	988	"60"+"80";"70"+"70"	1520	1480	1582	1622
"90"	976	946	918	1048	1088	"60"+"90";"70"+"80"	1620	1580	1682	1722
"90 plus"	986	956	928	1058	1098	"70"+"90";"80"+"80"	1720	1680	1782	1822
"100"	1076	1046	1018	1148	1188	"80"+"90"	1820	1780	1882	1922
						"90"+"90"	1920	1880	1982	2022

HEIGHT

Tolerance of dimensions ±1 mm	H _o	H _d	H _s	H _{opA}	H _{opB}
	2055	2043	2020	2093	2113
So - installation opening width	Ho - installation opening height				
Sd - door width on the door frame external side	Hd - door height on the external side of the door frame				
Ss - door leaf width	Hs - door leaf height				
SopA - door frame width along architraves "60"	HopA - door frame height along architraves "60"				
SopB - door frame width along architraves "80"	HopB - door frame height along architraves "80"				

ADJUSTABLE door frame AQUA DIN



single-leaf door	ECO TOP	HIGH TOP	PAINTED white 001	PAINTED grey, beige	BLACK black, sage	VENEERED		
		LAMISTONE CPL				SILKSTONE	UNI MAT PLUS	GROUP A
ZP1A	75-85							
ZP1B	85-95							
ZP2	95-120							
ZP3	120-140							
ZP4	140-160							
ZP5	160-180							
ZP6	180-200							
ZP7	200-220							
ZP8	220-240							
ZP9	240-260							
ZP10	260-280							
ZP11	280-300							

EXTRA CHARGE TABLE for RAL, NCS door frames acc. to the colour groups*	GROUP I	GROUP II	GROUP III	GROUP IV	GROUP V
	+20%	+30%	+40%	+60%	+75%

architraves interconnected at an angle of 45°

EXTRA CHARGES

architraves interconnected at an angle of 90° (version C 90° architrave only)

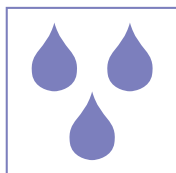

door frame made of high quality MDF with high resistance to moisture

Version A: 60 mm
(except the painted door)
Version B: 80 mm

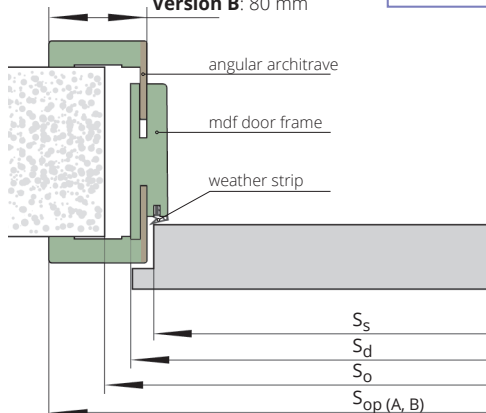

WIDTH										
single-leaf door						double-leaf door				
type	So	Sd	Ss	SopA	SopB	type	So	Sd	SopA	SopB
"60"	676	646	618	748	788	"60"+"60"	1310	1280	1382	1422
"70"	776	746	718	848	888	"60"+"70"	1410	1380	1482	1522
"80"	876	846	818	948	988	"60"+"80","70"+"70"	1510	1480	1582	1622
"90"	976	946	918	1048	1088	"60"+"90","70"+"80"	1610	1580	1682	1722
"90 plus"	986	956	928	1058	1098	"70"+"90","80"+"80"	1710	1680	1782	1822
"100"	1076	1046	1018	1148	1188	"80"+"90"	1810	1780	1882	1922
						"90"+"90"	1910	1880	1982	2022

HEIGHT	Ho	Hd	Hs	HopA	HopB
Tolerance of dimensions ±1 mm	2053	2043	2020	2093	2113

So - installation opening width
Sd - door width on the door frame external side
Ss - door leaf width
SopA - door frame width along architraves "60"
SopB - door frame width along architraves "80"

Ho - installation opening height
Hd - door height on the external side of the door frame
Hs - door leaf height
HopA - door frame height along architraves "60"
HopB - door frame height along architraves "80"



ADJUSTABLE door frame DIN DUO SYSTEM



single-leaf
door

ECO TOP	HIGH TOP	laminated CPL 0.2	PAINTED* white
	LAMISTONE CPL		
	SILKSTONE		
	UNI MAT PLUS		

ZD1	75-80
ZD2	80-85
ZD3	85-95
ZD4	95-120
ZD5	120-140
ZD6	140-160
ZD7	160-180
ZD8	180-200
ZD9	200-220
ZD10	220-240
ZD11	240-260
ZD12	260-280
ZD13	280-305

single-leaf
door

PAINTED* grey, beige	BLACK black, sage	VENEERED		
		GROUP A	GROUP B	GROUP C, D

ZD1	75-80
ZD2	80-85
ZD3	85-95
ZD4	95-120
ZD5	120-140
ZD6	140-160
ZD7	160-180
ZD8	180-200
ZD9	200-220
ZD10	220-240
ZD11	240-260
ZD12	260-280
ZD13	280-305

EXTRA CHARGES

Door frames with ranges wider than the maximum ones provided in the above table are available (upon consultation with the Sales Department). The installation door width must be enlarged by 15 mm for the DUO non-rebated system door leaves equipped with the HOBES lock.

*environment-friendly acrylic paints, RAL and NCS colours (except metallic ones) – available at an extra charge according to the colour groups (p. 264)

** for leaves equipped with the ECO Schulte GBS 12 lock - extra charge, the installation opening width additionally increased by 25 mm

***NOTES! The recommended dimension of the installation opening height increased by 16 mm.

double-leaf door	+50%
door frames lower by 55 mm or 100 mm	without an extra charge
door frames higher by 50 mm or 100 mm	+10%
door frames higher by 150 mm or 200 mm	+20%
"100"	
"110"	
reinforcement for an arm/guide rail door closer***	
architraves interconnected at an angle of 90° – version B 90°, version C 90°	
electric strike BIRA HARTTE XS narrow with tongue guide (NO type) XS12R-C 12V DC (including SPEC-525 strike plate and milling for the electric strike)**	
electric strike BIRA HARTTE XS narrow with tongue guide (NO type) XS12U-C 12V AC/DC (including SPEC-525 strike plate and milling for the electric strike)**	
electric strike BIRA HARTTE XS narrow with tongue guide (NO type) XS12UW-C 12V AC/DC (including SPEC-525 strike plate and milling for the electric strike)**	
crown	p. 248

new method of connecting architraves – p. 254

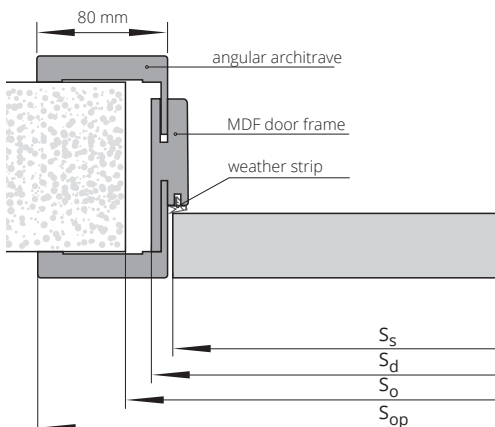

EXTRA CHARGE TABLE for RAL, NCS door frames acc. to the colour groups*	GROUP I	GROUP II	GROUP III	GROUP IV	GROUP V
	+20%	+30%	+40%	+60%	+75%

WIDTH

type	single-leaf door				double-leaf door			
	So	Sd	Ss	Sop	So	Sd	Sop	
"60"	690	652	625	794	"60"+"60"	1304	1266	1408
"70"	790	752	725	894	"60"+"70"	1404	1366	1508
"80"	890	852	825	994	"60"+"80","70"+"70"	1504	1466	1608
"90"	990	952	925	1094	"60"+"90","70"+"80"	1604	1566	1708
"90 plus"	1015	977	950	1119	"70"+"90","80"+"80"	1704	1666	1808
"100"	1090	1052	1025	1194	"80"+"90"	1804	1766	1908
					"90"+"90"	1904	1866	2008

HEIGHT

Tolerance of dimensions ±1 mm	Ho	Hd	Hs	Hop
	2075	2063	2040	2133

Ss - door leaf width
Sd - door width on the door frame external side
So - installation opening width
Sop - width on the external side of the architrave

Hs - door leaf height
Hd - door height on the external side of the door frame
Ho - installation opening height
Hop - architrave external height

ADJUSTABLE door frame AQUA DIN DUO

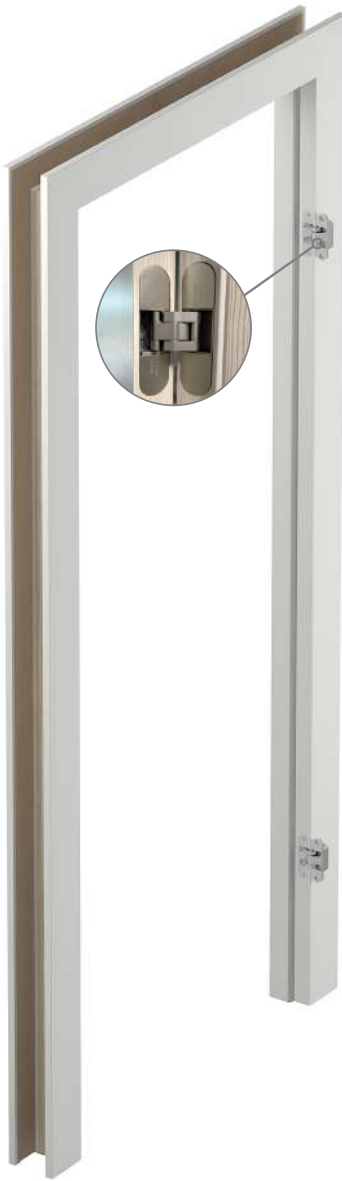

single-leaf
door

ECO TOP	UNI MAT PLUS	HIGH TOP
		LAMISTONE CPL
		SILKSTONE
		laminated CPL 0.2

ZD1	75-80
ZD2	80-85
ZD3	85-95
ZD4	95-120
ZD5	120-140
ZD6	140-160
ZD7	160-180
ZD8	180-200
ZD9	200-220
ZD10	220-240
ZD11	240-260
ZD12	260-280
ZD13	280-305

single-leaf door	PAINTED white	PAINTED grey, beige	VENEERED			BLACK black, sage
			GROUP A	GROUP B	GROUP C, D	
ZD1	75-80					
ZD2	80-85					
ZD3	85-95					
ZD4	95-120					
ZD5	120-140					
ZD6	140-160					
ZD7	160-180					
ZD8	180-200					
ZD9	200-220					
ZD10	220-240					
ZD11	240-260					
ZD12	260-280					
ZD13	280-305					

EXTRA CHARGES for RAL, NCS door frames acc. to the colour groups*	GROUP I	GROUP II	GROUP III	GROUP IV	GROUP V
	+20%	+30%	+40%	+60%	+75%

architraves interconnected at an angle of 45°

**EXTRA
CHARGES**

architraves interconnected at an angle of 90° (version C 90° architrave only)

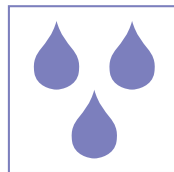

**door frame made of high quality MDF with
high resistance to moisture.**

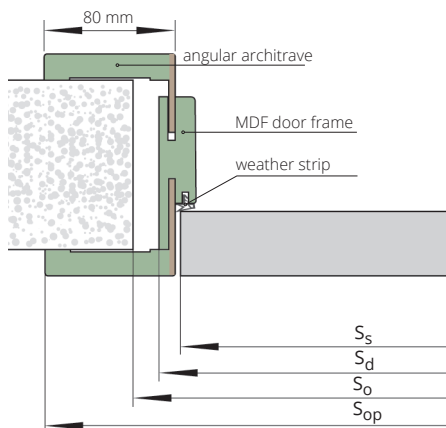

WIDTH

type	single-leaf door				double-leaf door			
	So	Sd	Ss	Sop	type	So	Sd	Sop
"60"	690	652	625	794	"60"+"60"	1304	1266	1408
"70"	790	752	725	894	"60"+"70"	1404	1366	1508
"80"	890	852	825	994	"60"+"70", "70"+"70"	1504	1466	1608
"90"	990	952	925	1094	"60"+"90", "70"+"80"	1604	1566	1708
"90 plus"	1015	977	950	1119	"70"+"90", "80"+"80"	1704	1666	1808
"100"	1090	1052	1025	1194	"80"+"90"	1804	1766	1908
					"90"+"90"	1904	1866	2008

HEIGHT

Tolerance of dimensions ±1 mm	Ho	Hd	Hs	Hop
	2075	2063	2040	2133

Ss - door leaf width
Sd - door width on the door frame external side
So - installation opening width
Sop - width on the external side of the architrave

Hs - door leaf height
Hd - door height on the external side of the door frame
Ho - installation opening height
Hop - architrave external height



ADJUSTABLE door frame VERTIGO

ARCHITRAVE AND CROSS RAIL CONNECTION SYSTEM

Door frame vertical wood grain (LAMISTONE: 241, 242; SILKSTONE: 293, 294, 295)
 Door frame horizontal wood grain (SILKSTONE: 254, 255, 299)
 Horizontal wood grain (SILKSTONE: 254, 255, 299)
 Vertical wood grain (LAMISTONE: 241, 242; SILKSTONE: 293, 294, 295)

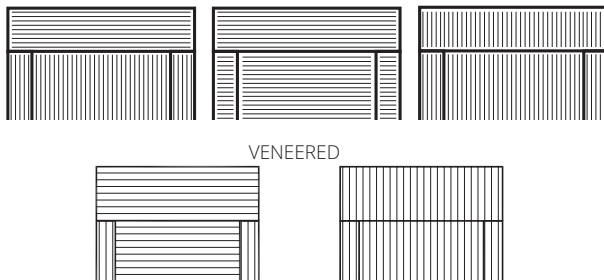

single-leaf door	complete set (panel/adjustment architrave) in mm	UNI MAT PLUS	LAMISTONE CPL	SILKSTONE	PAINTED* white	PAINTED* grey, beige	BLACK black, sage	VENEERED		
		symbol	range in mm	range in mm	GROUP A	GROUP B	GROUP C, D			
ZV1	75-80	75/12								
ZV2	80-85	80/12								
ZV3	85-95	85/16								
ZV4	95-120	95/32								
ZV5	120-140	120/32								
ZV6	140-160	140/32								
ZV7	160-180	160/32								
ZV8	180-200	180/32								
ZV9	200-220	200/32								
ZV10	220-240	220/32								
ZV11	240-260	240/32								
ZV12	260-280	260/32								
ZV13	280-305	280/32								

EXTRA CHARGES

door frames lower by 55 mm or 100 mm without an extra charge
 door frames higher by 50 mm or 100 mm +10%
 reinforcement for the surface-mounted door closer**

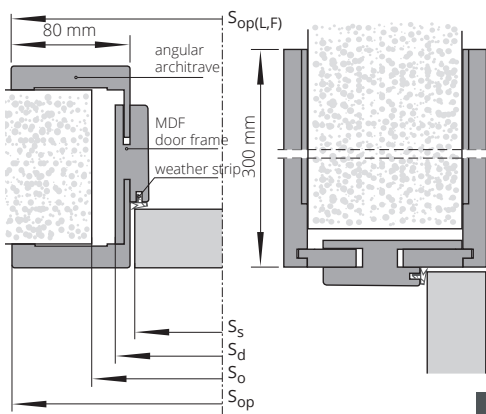

electric strike BIRA HARTTE XS narrow with tongue guide (NO type) XS12R-C 12V DC (including SPEC-525 strike plate and milling for the electric strike)***
 electric strike BIRA HARTTE XS narrow with tongue guide (NO type) XS12U-C 12V AC/DC (including SPEC-525 strike plate and milling for the electric strike)***
 electric strike BIRA HARTTE XS narrow with tongue guide (NO type) XS12UW-C 12V AC/DC (including SPEC-525 strike plate and milling for the electric strike)***

Door frames with ranges wider than the maximum ones provided in the above table are available (upon consultation with the Sales Department).
 *environment-friendly acrylic paints, RAL and NCS colours (except metallic ones) – available at an extra charge according to the colour groups (p. 264)

**NOTES! The recommended dimension of the installation opening height increased by 16 mm.
 *** for door leaves equipped with the ECO Schulte GBS 12 lock - extra charge of , the installation opening width increased by 15 mm

COMPLETE SET PRICE = VERTIGO DOOR FRAME PRICE + VERTIGO PANEL PRICE

VERTIGO PANEL 1 set (2 pcs)

VERTIGO upper panels have R3 radii on the vertical edges in versions LAMISTONE SILKSTONE, UNI MAT PLUS and painted. Except the veneered version.

height of panels	UNI MAT PLUS	LAMISTONE CPL	SILKSTONE	PAINTED* white	PAINTED* grey, beige	BLACK black, sage	VENEERED			
	GROUP A	GROUP A herringbone	GROUP B	GROUP C, D						
100 mm										
200 mm										
300 mm										
400 mm										
500 mm										
600 mm										
700 mm										
800 mm										
900 mm										
1000 mm										

WIDTH						
single-leaf door						
type	S ₀	S _d	S _s	S _{op}	S _{opL}	S _{opF}
"60"	690	652	625	793	793	795
"70"	790	752	725	893	893	895
"80"	890	852	825	993	993	995
"90"	990	952	925	1093	1093	1095
"90 plus"	1015	977	950	1117	1118	1120

HEIGHT			
	H ₀	H _d	H _{op}
	2082	2070	2353

S_s - door leaf width
 S_d - door width on the door frame external side
 S₀ - installation opening width
 S_{op} - door frame dimension on the hinge side
 S_{opL} - door frame dimension on the adjustment side for laminated and painted door frame
 S_{opF} - door frame dimension on the adjustment side for veneered door frame
 H_s - door leaf height
 H_d - door height on the external side of the door frame
 H₀ - installation opening height
 H_{op} - architrave external height



ADJUSTABLE door frame REVES SYSTEM



for the single-leaf door	ECO TOP	laminated CPL 0.2	PAINTED*		BLACK	VENEERED		
		UNI MAT PLUS	white	grey, beige	black, sage	GROUP A	GROUP B	GROUP C, D
	HIGH TOP	LAMISTONE CPL	in mm					
range in mm	SILKSTONE							
ZW1	75-95							
ZW2	95-115							
ZW3	115-135							
ZW4	135-155							
ZW5	155-175							
ZW6	175-195							
ZW7	195-215							
ZW8	215-235							
ZW9	235-255							
ZW10	255-275							
ZW11	275-295							

EXTRA CHARGES

- door frame higher by 100 mm +10%
- change of colour of the chrome matt hinge to black (RAL 9005) or white (RAL 9016)
- architraves interconnected at an angle of 45° angle (no possibility of interconnecting at 90°)
- * RAL, NCS palette colours (except metallic ones) - extra charge acc. to the colour table

type	So	Sd	Ss	SopA	SopB	SopBF	type	Hd	HopA	HopB	Hs	Ho
"60"	705	676	625	768	818	820	standard	2088	2133	2158	2053	2105
"70"	805	776	725	868	918	920	+50	2138	2183	2208	2103	2155
"80"	905	876	825	968	1018	1020	+100	2188	2233	2258	2153	2205
"90"	1005	976	925	1068	1118	1120	+200	2288	2333	2358	2253	2305
"90 plus"	1030	1001	950	1093	1143	1145	-55	2033	2078	2103	1998	2050
"100"	1105	1076	1025	1168	1218	1220	-100	1988	2033	2058	1953	2005

Tolerance of dimensions ±1 mm

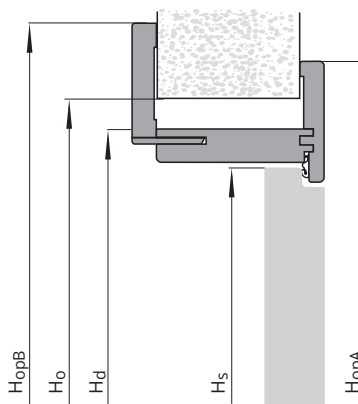
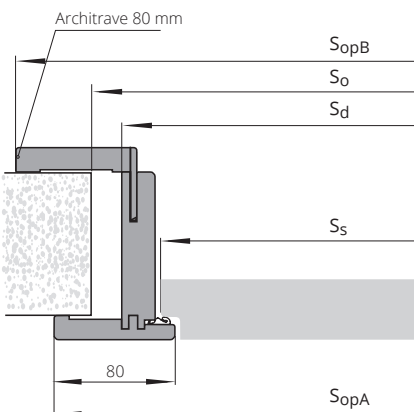

Ss - door leaf width
Sd - door width on the door frame external side
So - installation opening width
SopA - width on the architrave external side from the hinge side
SopB - width on the architrave external side from the adjustment side
SopBF - dimension on the external side of the door frame for veneered door

Hs - door leaf height
Hd - door height on the external side of the door frame
Ho - installation opening height
HopA - height on the architrave external side from the hinge side
HopB - height on the architrave external side from the adjustment side



REVES SYSTEM

reverse rebate

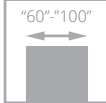

leaf in the REVES system (left side), right-hand - inward-opening;
leaf in the DUO system (right side), left-hand - outward-opening

The door is built of a **wooden rail and stile set** topped with two HDF boards. The standard in-fill is a honeycomb-like layer. Perforated chipboard infill and solid chipboard infill available at an extra charge. The REVES door leaf is available in glazed models: IMPULS W13, IMPULS W14, ESTATO A01, ESTATO A02, ESTATO A03, ESPINA W01, CREATO A01, CREATO A02, CREATO A03, ESTATO LUX A01, ESTATO LUX A02, ESTATO LUX A03. REVES leaf available as flush models (without glazings): CAMBIO, SIMPLE, SUBLIME, TIARA, VERTIGO, VILANO, MODERN, MODENA, LOFTY, INTER-AMBER, HAPTIC, IMPULS, SONATA, INVERNO, NOSTRE, DECO, ESPINA, DECO LUX, SONATA LUX, ESTATO, CREATO, ESTATO LUX, PALAZZO.

The combination of the DUO and REVES systems gives new interior arrangement opportunities. It enables the door opening in various directions to have an identical appearance when seen from the corridor side. The plane surface in both systems is flush with the door frame surface, forming a single plane with it. The hinges remain hidden and hence no difference in their design will be noticeable from the corridor side.



hidden DUO hinge, silver colour
- DUO system



hidden TE hinge, silver colour
- REVES system (reversed rebate)

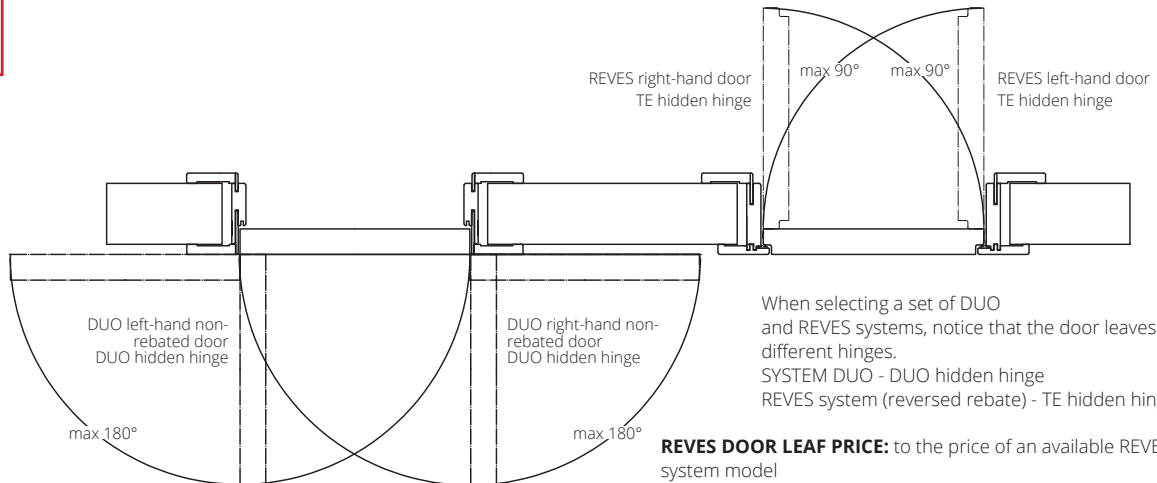

REVES DOOR LEAF PRICE: to the price of an available REVES system model
REVES door frame price: p. 220



door leaf in the REVES system (on the left), right-hand - inward-opening; door leaf in the DUO system (on the right), left-hand - outward-opening

EQUIPMENT

STANDARD

magnetic mortise lock, for key (spacing: 90 mm), for cylinder (spacing: 85 mm) or bathroom privacy lock (spacing: 90 mm)
hinges: hidden TE, chrome satin colour ("60" - "80" - 2 pcs; "90" - "100" - 3 pcs)
architraves interconnected at an angle of 45° (no possibility of connecting at an angle of 90°)
not available with an electric strike

ABS edging is not available

ADDITIONAL (available at an extra charge)

perforated chipboard in-fill

solid chipboard in-fill (third hinge recommended)

drop seal

third hinge in the door leaf (price per 1 piece):

concealed TE type for a width of "60"-"80"

change of standard lock

chrome satin colour

to white or black colour (price per 1 piece)

change of standard lock, silver colour, to

black or golden polished colour

door higher by 50 mm or 100 mm (third hinge required at an extra charge) **+10%**

door higher by 200 mm (third hinge required at an extra charge) Cambio 00, Lofty, Inter Amber A00, Haptic 00, Impuls W01, Deco 00, Deco Lux 00 **+20%**

door lower by 55 mm or 100 mm **without an extra charge**

maximum height of door with the REVES frame - 2288 mm





MDF-BASED **ADJUSTMENT SYSTEM** for FIXED METAL door frame



Dedicated to:
 Non-rebated metal door frame FD93
 Fixed metal door frame FD12
 Fixed metal door frame for doors RC3, RC3 INVEST
 Fixed metal door frame for door CERBER PLUS, CERBER PLUS, RC2

COLOURS

Fixed metal door frame FD12, FD93, RC3,
 Cerber Plus: powder-painted in RAL colours
 Adjustment with MDF: ECO TOP, HIGH TOP, LAMISTONE,
 SILKSTONE, VENEERED GROUP A,B, C.



single-leaf door	symbol	range in mm (*)	ECO TOP	laminated CPL 0.2	VENEERED		
				HIGH TOP	GROUP A	GROUP B	GROUP C, D
				LAMISTONE CPL			
				SILKSTONE			
MA1	MB1	175-195					
MA2	MB2	195-215					
MA3	MB3	215-235					
MA4	MB4	235-255					
MA5	MB5	255-275					
MA6	MB6	275-295					
MA7	MB7	295-315					
MA8	MB8	315-335					
MA9	MB9	335-355					
MA10	MB10	355-375					
MA11	MB11	375-395					
MA12	MB12	395-415					

EXTRA CHARGES double-leaf door **+50%**

(*) the range of adjustment includes the FD12, CERBER PLUS, RC3, FD93 door frame thickness
 MA: adjustment systems for FD12, CERBER PLUS, RC3
 MB: adjustment systems for FD93

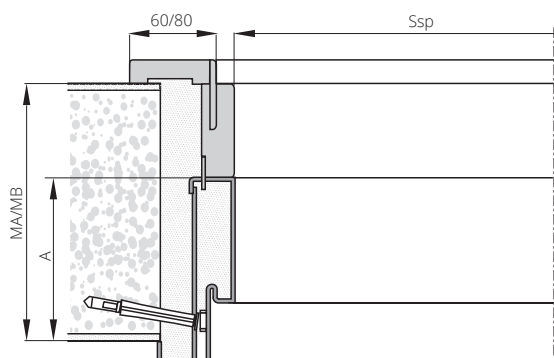

module	WIDTH (Ssp)							
	single-leaf door							
	FD12		CERBER PLUS CERBER PLUS RC2		RC3 RC3 INVEST		FD93	
	SopA	SopB	SopA	SopB	SopA	SopB	SopA	SopB
"60"	746	786	-	-	-	-	749	786
"70"	846	886	-	-	-	-	849	889
"80"	946	986	946	986	946	986	949	989
"90"	1046	1086	1046	1086	1046	1086	1049	1089
"90" Plus	1056	1096	1056	1096	1066	1106	1074	1114
"100"	1146	1186	1146	1186	1146	1186	1149	1189
"110"	1246	1286	-	-	-	-	1249	1289
A -	109		109		112		109	
HopA	2092		RC3 Invest - 2092		RC4, RC4 EI30 - 2087		HopA - 2112	
HopB	2112		RC3 Invest - 2112		RC4, RC4 EI30 - 2107		HopB - 2132	

SopA - width on the external side of architraves 60 mm
 SopB - width on the external side of architraves 80 mm
 HopA - height on the external side of architraves 60 mm
 HopB - height on the external side of architraves 80 mm

COLOURS

METAL DOOR FRAMES

Standard colours available in the standard SEMI-MATT surface finish

STANDARD COLOURS

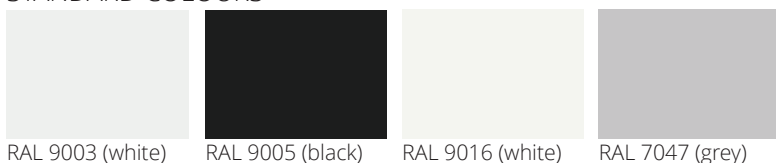

RAL 9003 (white) RAL 9005 (black) RAL 9016 (white) RAL 7047 (grey)



RAL 8014 (brown) RAL 7024 (graphite) NCS S 2005 Y50R (beige)

051 RAL 9003 structure 052 RAL 9005 structure 050 Anthracite structure 053 Copper structure



TABLE OF EXTRA CHARGES FOR RAL COLOURS
door frames are not available in NCS colours

extra charge per door frame piece			
colour group	(1-5 pcs)	(6-10 pcs)	(over 10 pcs)
GROUP I	+20%	+10%	+5%
GROUP II	+30%	+20%	+10%
GROUP III	+35%	+20%	+10%
GROUP IV	+40%	+25%	+15%
GROUP V	+60%	+60%	+60%

TABLE OF EXTRA CHARGES - STRUCTURES

extra charge added to the price of the basic metal door frame

rebated system	+20%
non-rebated system	+10%
HARMONY in the colour of RAL 9003, RAL 9005	+10%

RAL PALETTE FOR DIVISION OF COLOURS (metal and aluminium door frames only)

GROUP I																																				
1000	1001	1002	1011	1013	1015	1019	1020	3009	4001	5000	5001	5004	5005	5007	5008	5009	5010	5011	5013	5014	5017	5019	5020	5021	5022	5023	5024	6000	6003							
6004	6005	6006	6007	6008	6011	6012	6013	6014	6015	6019	6020	6026	6027	6033	6034	7000	7001	7002	7003	7004	7005	7006	7008	7009	7010	7011	7012	7013	7015							
7016	7021	7022	7023	7026	7030	7031	7032	7033	7034	7035	7036	7037	7038	7039	7040	7042	7043	7044	7045	7046	8000	8001	8002	8003	8004	8007	8011	8012	8015							
8017	8019	8022	8023	8024	8025	8028	9001	9002	9010	1024HR	6021HR	9004HR	9005HR																							
GROUP II																																				
1014	3000	3001	3002	3004	3007	3011	3013	3016	4002	4008	5002	5003	5012	5015	5018	6017	6022	6025	6029	9018	3031HR	4005HR	4006HR	6002HR	8008HR											
GROUP III																																				
3003	3005	3020	3022	6010	6018	6024	1024HR	4004HR	4010HR	6032HR																										
GROUP IV																																				
3012	3014	6001	6028	3027HR	4003HR	4007HR	6037HR																													
GROUP V																																				
1003	1004	1005	1006	1016	1017	1018	1021	1023	1027	1032	1033	1034	1037	2000	2001	2002	2004	2009	2010	2011	2012	3018	1027HR	1028HR	2003HR	2008HR	3028HR	9006								

The RAL colours of metal door frames and aluminium door frames differs from the RAL colours of painted door leaves due to the different material application technology.

COLOURS OF METAL DOOR FRAMES VS CPL LAMINATES

colours of metal door frames	COLOURS of CPL laminate POL-SKONE (all b.m. laminate colours similar to RAL colours)			COLOURS OF CPL POL-SKONE EGGER (all b.m. laminate colours similar to RAL colours)			COLOURS OF CPL POL-SKONE KRONOSPAN (all b.m. laminate colours similar to RAL colours)		
	CPL 0.2 mm	CPL 0.5 mm	CPL 0.7 mm	CPL 0.2 mm	CPL 0.6 mm	CPL 0.8 mm	CPL 0.2 mm	CPL 0.5 mm	CPL 0.6 mm
RAL 9016	820	920	720	W980 SM	W980 SM	W980 SM	8100 BS	8100 BS	8100 BS
RAL 1001	no match	no match	no match	no match	no match	no match	no match	no match	no match
RAL 7047	-	-	-	U708 SM	U708 SM	U708SM	112 BS	112 BS	112 BS
RAL 7024	821	921	721	U963 ST 9	U963 ST9	U963 ST9	164 BS	164 BS	164 BS
RAL 8014	-	-	-	U808 ST9	U808 ST9	U808 ST9	182 BS	182 BS	182 BS
RAL 7035	222	259	772	-	-	-	-	-	-

colour matching suggestion to be individually verified

EGGER structure: SM - smooth surface, ST 9 - orange peel structure
EGGER formats available: 960x2060 mm; 1160x2060 mm and heights 2160 mm; 2260 mm

KRONOSPAN structure: BS - orange peel structure, SM - smooth structure
KRONOSPAN available formats: 1320x2060 mm; 1100x2060 mm and other heights 2160 mm; 2260 mm



FIXED METAL DUO door frame POL-SKONE SYSTEM



NOTE! THE PRICE OF THE DUO METAL DOOR FRAME INCLUDES DUO HIDDEN HINGES

DEDICATED TO

Interior door

Metal non-rebated door frame compatible with DUO hidden hinges, made of 1.5 mm thick metal sheet.

COLOURS

Powder-coated door frame.
Standard colours: white (RAL 9003), black (RAL 9005), white (RAL 9016), grey (RAL 7047), brown (RAL 8014), graphite (RAL 7024), beige (NCS S 2005 Y50R)
Other colours from the RAL palette are available at an extra charge - according to the table of extra charges (p.223)



		single-leaf door			double-leaf door		
symbol	range in mm	"60"÷"80"	"90"	"100"÷"110"	"60"÷"60", "60"÷"70", "60"÷"80" "70"÷"70", "70"÷"80"	"90"÷"60"	"160"÷"200"
FD93	101						
number of hidden hinges		2 pcs	3 pcs	3 pcs	4 pcs	6 pcs	6 pcs

ACCESSORIES AND EQUIPMENT
(available at extra charge)

door frame shorter by 55 mm or 100 mm	+10%
door frame higher by 50 mm	+5%
door frame higher by 100 mm	+10%
door frame higher by 150 mm	+15%
door frame higher by 200 mm	+20%
reinforcement for the top-mounted door closer	
reinforcement for hidden door closer GEZE BOXER 2-4; ITS 96 2-4	
DUO hinge for metal door frame (hidden) - 1 piece	
electric strike BIRA with tongue guide (NO type) F12R-C (12V DC) (including SPEC-727 strike plate and milling for the electric strike)*	
electric strike BIRA with tongue guide (NC type) F12U-C (12V AC/DC) (including SPEC-727 strike plate and milling for the electric strike)*	
MC 250 mortise reed switch	
MC200-S19 mounting flange for reed switch (white colour) (for metal door frames)	

*for door leaves equipped with the ECO Schulte GBS 12 lock, extra charge **+ 12**

The installation opening must be enlarged by additional 5 mm for door frames equipped with an electric strike.

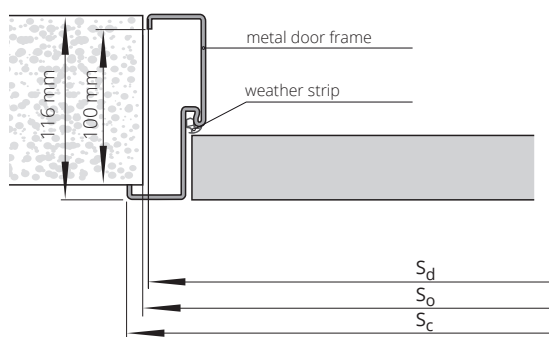

S_d - door width on the door frame external side
S_o - installation opening width
S_c - total door frame width

H_d - door height on the external side of the door frame
H_o - installation opening height
H_c - door frame total height

WIDTH

		single-leaf door			double-leaf door		
type	S _o	S _d	S _c	type	S _o	S _d	S _c
"60"	685	675	701	"120"	1300	1290	1316
"70"	785	775	801	"130"	1400	1390	1416
"80"	885	875	901	"140"	1500	1490	1516
"90"	985	975	1001	"150"	1600	1590	1616
"90"plus	1010	1000	1026	"160"	1700	1690	1716
"100"	1085	1075	1101	"170"	1800	1790	1816
"110"	1185	1175	1201	"180"	1900	1890	1916
				"190"	2000	1990	2016
				"200"	2100	2090	2116

HEIGHT

	H _o	H _c	H _d
	2080	2088	2075



FIXED METAL door frame POL-SKONE SYSTEM

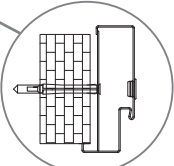
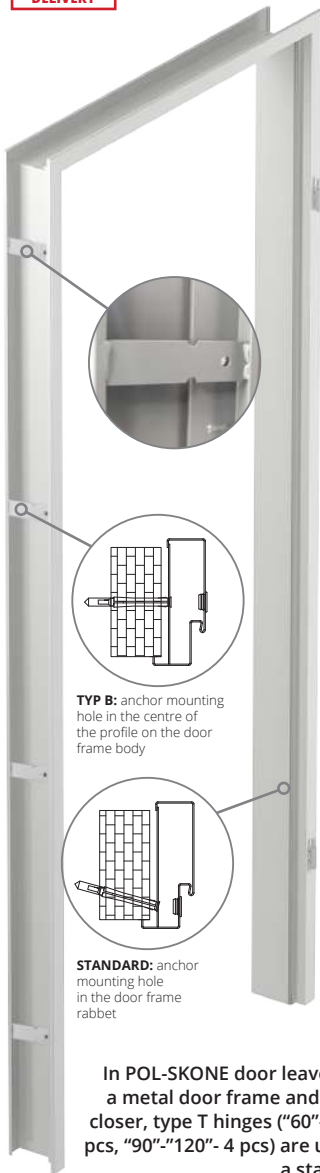

TYP B: anchor mounting hole in the centre of the profile on the door frame body

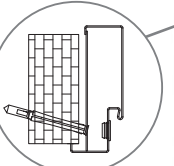

STANDARD: anchor mounting hole in the door frame rabbet

In POL-SKONE door leaves with a metal door frame and a door closer, type T hinges ("60"- "80"- 3 pcs, "90"- "120"- 4 pcs) are used as a standard.

An in-wall cavity must be made for the cover boxes.

S_d - door width on the door frame external side
S_o - installation opening width
S_c - door frame total width

H_d - door height on the external side of the door frame
H_o - installation opening height
H_c - total door frame width

DEDICATED TO

Interior door
Metal door frames with varying sheet thickness depending on the type:
FD14 - thickness 1.5 mm
FD12 - thickness 1.5 mm

COLOURS

Powder-coated door frame.
Standard colours: white (RAL 9003), black (RAL 9005), white (RAL 9016), grey (RAL 7047), brown (RAL 8014), graphite (RAL 7024), beige (NCS S 2005 Y50R)
Other colours from the RAL palette are available at an extra charge - according to the table of extra charges (p.223)



	single-leaf door		double-leaf door	
door frame type	"60"÷"90"	"100" ÷ "120"	"120"÷"150"	"160"÷"200"
FD14 small				
FD12 large*				

ACCESSORIES AND EQUIPMENT

(available at extra charge)

* mounting holes on the door frame surface are available

door frame shorter by 50 mm or 100 mm	+10%
door frame higher by 50 mm	+5%
door frame higher by 100 mm	+10%
door frame higher by 150 mm	+15%
door frame higher by 200 mm	+20%
stainless steel threshold for the FD12 door frame - 1 piece	
reinforcement for the top-mounted door closer	
additional type M hinge for the metal door frame (width "60"+ "80") - 1 piece	
change of hinge to type T for the metal door frame (width "60"+ "80") - 1 piece	
electric NC strike BIRA F12U (12V AC/DC) including catch plate and adaptation for the electric strike	
electric NO strike BIRA F12R (12V DC) including catch plate and adaptation for the electric strike	
MC 250 mortise reed switch	
MC200-S19 mounting flange for reed switch (white colour) (for metal door frames)	

WIDTH FD14				WIDTH FD12			
single-leaf door		double-leaf door		single-leaf door		double-leaf door	
type	S _o	S _d	S _c	type	S _o	S _d	S _c
"60"	673	633	697	"120"	1307	1267	1331
"70"	773	733	797	"130"	1407	1367	1431
"80"	873	833	897	"140"	1507	1467	1531
"90"	973	933	997	"150"	1607	1567	1631
"90"plus	983	943	1007	"160"	1707	1667	1731
"100"	1073	1033	1097	"170"	1807	1767	1831
"110"	1173	1133	1197	"180"	1907	1867	1931
"120"	1273	1233	1297	"190"	2007	1967	2031
				"200"	2107	2067	2131
HEIGHT				HEIGHT			
				H _d	H _o	H _c	
				2036	2046	2068	

WIDTH FD14				WIDTH FD12			
single-leaf door		double-leaf door		single-leaf door		double-leaf door	
type	S _o	S _d	S _c	type	S _o	S _d	S _c
"60"	681	671	697	"120"	1315	1305	1331
"70"	781	771	797	"130"	1415	1405	1431
"80"	881	871	897	"140"	1515	1505	1531
"90"	981	971	997	"150"	1615	1605	1631
"90"plus	991	981	1007	"160"	1715	1705	1731
"100"	1081	1071	1097	"170"	1815	1805	1831
"110"	1181	1171	1197	"180"	1915	1905	1931
"120"	1281	1271	1297	"190"	2015	2005	2031
				"200"	2115	2105	2131
HEIGHT				HEIGHT			
				H _d	H _o	H _c	
				2055	2060	2068	

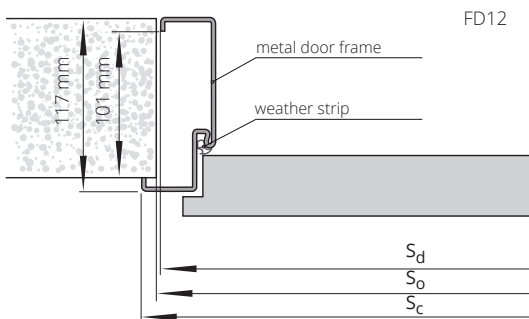
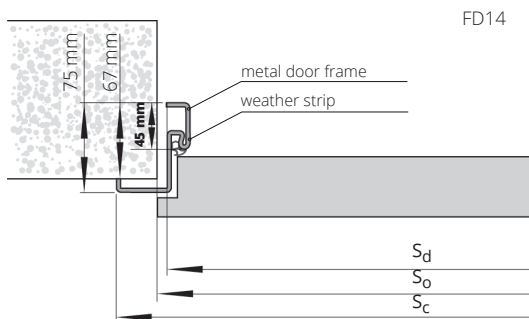

The installation opening must be enlarged by additional 5 mm for door frames equipped with an electric strike.



ADJUSTABLE METAL DUO door frame POL-SKONE SYSTEM

NOTE! THE PRICE OF THE DUO METAL DOOR FRAME INCLUDES DUO HIDDEN HINGES

DEDICATED TO

Interior door

Non-rebated metal door frame compatible with the DUO concealed hinges. Door frame made of 1.5 mm thick metal sheet.

COLOURS

Powder-coated door frame.

Standard colours: white (RAL 9003), black (RAL 9005), white (RAL 9016), grey (RAL 7047), brown (RAL 8014), graphite (RAL 7024), beige (NCS S 2005 Y50R)

Other colours from the RAL palette are available at an extra charge - according to the table of extra charges (p.223)



		single-leaf door			double-leaf door		
symbol	range in mm	"60" - "80"	"90"	"100" - "110"	"60"+"60", "60"+"70", "60"+"80", "70"+"70", "70"+"80"	"90"+"60"	"160"- "200"
F71	95-125						
F72	125-155						
F73	155-185						
F74	185-215						
F75	215-245						
F76	245-275						
F77	275-305						
F78	305-335						
F79	335-365						
number of hidden hinges		2 pcs	3 pcs	3 pcs	4 pcs	6 pcs	6 pcs

NOTE! The price includes DUO hinges for the metal door frame.

ACCESSORIES AND EQUIPMENT
(available at extra charge)

door frame shorter by 55 mm or 100 mm	+10%
door frame higher by 50 mm	+5%
door frame higher by 100 mm	+10%
door frame higher by 150 mm	+15%
door frame higher by 200 mm	+20%
reinforcement for the top-mounted door closer	
DUO hinge for metal door frame (hidden) - 1 piece	
electric strike BIRA with tongue guide (NO type) F12R-C (12V DC) (including SPEC-727 strike plate and milling for the electric strike)*	
electric strike BIRA with tongue guide (NC type) F12U-C (12V AC/DC) (including SPEC-727 strike plate and milling for the electric strike)*	
additional ZOX adjustment system for the non-rebated adjustable door frame (wall width range increase ` 650 mm)	
MC 250 mortise reed switch	
MC200-S19 mounting flange for reed switch (white colour) (for metal door frames)	

*for door leaves equipped with the ECO Schulte GBS 12 lock, extra charge **+ 12**

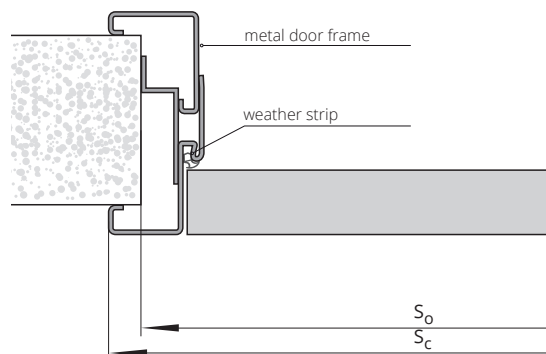

	single-leaf door			double-leaf door		
	type	Sc	So	type	Sc	So
WIDTH	"60"	721	693	"120"	1336	1308
	"70"	821	793	"130"	1436	1408
	"80"	921	893	"140"	1536	1508
	"90"	1021	993	"150"	1636	1608
	"90"plus	1046	1018	"160"	1736	1708
	"100"	1121	1093	"170"	1836	1808
	"110"	1221	1193	"180"	1936	1908
				"190"	2036	2008
				"200"	2136	2108
	HEIGHT				Ho	Hc
				2085	2098	

So - installation opening width
Sc - door frame total width

Ho - installation opening height
Hc - door frame total height



ADJUSTABLE METAL door frame POL-SKONE SYSTEM



In POL-SKONE interior door leaves with a metal door frame and door closer, type T hinges ("60"- "80"- 3 pcs, "90"- "120"- 4 pcs) are used as a standard.

DEDICATED TO

Interior door

Door frame made of 1.5 mm thick metal sheet.

COLOURS

Powder-coated door frame.

Standard colours: white (RAL 9003), black (RAL 9005), white (RAL 9016), grey (RAL 7047), brown (RAL 8014), graphite (RAL 7024), beige (NCS S 2005 Y50R)

Other colours from the RAL palette are available at an extra charge - according to the table of extra charges (p.223)



symbol	range mm	single-leaf door		double-leaf door	
		"60"±"90"	"100"±"120"	"120"±"150"	"160"±"200"
ZO1	95-125				
ZO2	125-155				
ZO3	155-185				
ZO4	185-215				
ZO5	215-245				
ZO6	245-275				
ZO7	275-305				
ZO8	305-335				
ZO9	335-365				

ACCESSORIES AND EQUIPMENT (available at extra charge)

door frame shorter by 50 mm or 100 mm	+10%
door frame higher by 50 mm	+5%
door frame higher by 100 mm	+10%
door frame higher by 150 mm	+15%
door frame higher by 200 mm	+20%
reinforcement for the top-mounted door closer	
additional type M hinge for the metal door frame (width "60"+"80") - 1 piece	
change of hinge to type T for the metal door frame (width "60"+"80") - 1 piece	
electric NC strike BIRA F12U (12V AC/DC) including catch plate and adaptation for the electric strike	
electric NO strike BIRA F12R (12V DC) including catch plate and adaptation for the electric strike	
additional ZOX adjustment system for the rebated adjustable frame (wall width range increase 635 mm)	
MC 250 mortise reed switch	
MC200-S19 mounting flange for reed switch (white colour) (for metal door frames)	

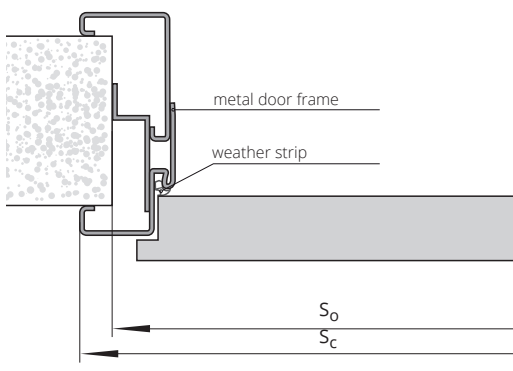

WIDTH									
type	single-leaf door				double-leaf door				
	S ₀	S _c	H ₀	H _c	type	S ₀	S _c	H ₀	H _c
"60"	690	717	2065	2078	"120"	1325	1351	2065	2078
"70"	790	817			"130"	1425	1451		
"80"	890	917			"140"	1525	1551		
"90"	990	1017			"150"	1625	1651		
"90" plus	1000	1027			"160"	1725	1751		
"100"	1090	1117	"170"	1825	1851				
"110"	1190	1217	"180"	1925	1951				
"120"	1290	1317	"190"	2025	2051				
			"200"	2125	2151				

S₀ - installation opening width
S_c - total door frame width

H₀ - installation opening height
H_c - door frame total height



FIXED

METAL DIAGONAL door frame

POL-SKONE SYSTEM



DEDICATED TO

Interior door

Door frame made of 1.5 mm thick metal sheet.

COLOURS

Powder-coated door frame.

Standard colours: white (RAL 9003), black (RAL 9005), white (RAL 9016), grey (RAL 7047), brown (RAL 8014), graphite (RAL 7024), beige (NCS S 2005 Y50R)

Other colours from the RAL palette are available at an extra charge - according to the table of extra charges (p.223)

single-leaf door		double-leaf door	
"60"÷"90"	"100" ÷ "120"	"120"÷"150"	"160"÷"200"
FD15 sheet thickness 1.5 mm			

ACCESSORIES AND EQUIPMENT (available at extra charge)

door frame shorter by 50 mm or 100 mm	+10%
door frame higher by 50 mm	+5%
door frame higher by 100 mm	+10%
door frame higher by 150 mm	+15%
door frame higher by 200 mm	+20%
reinforcement for the top-mounted door closer	
additional type M hinge for metal door frame (width "60"+"80") - 1 piece	
change of hinge to type T for the metal door frame (width "60"+"80") - 1 piece	
electric NC strike BIRA F12U (12V AC/DC) including catch plate and adaptation for the electric strike	
electric NO strike BIRA F12R (12V DC) including catch plate and adaptation for the electric strike	
MC 250 mortise reed switch	
MC200-S19 mounting flange for reed switch (white colour) (for metal door frames)	

In POL-SKONE interior door leaves with a metal door frame and door closer, type T hinges ("60"- "80" - 3 pcs, "90"- "120" - 4 pcs) are used as a standard.

Door frame made of the highest quality 1.5 mm steel sheet.

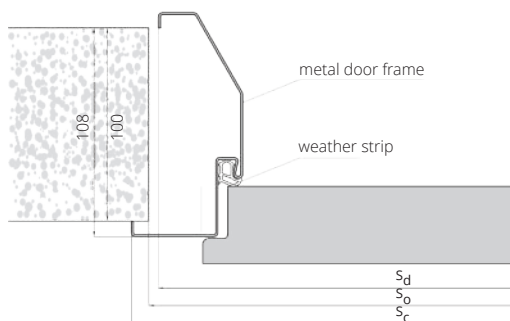

WIDTH

single-leaf door			double-leaf door				
type	S _o	S _d	S _c	type	S _o	S _d	S _c
"60"	700	691	717	"120"	1335	1325	1351
"70"	800	791	817	"130"	1435	1425	1451
"80"	900	891	917	"140"	1535	1525	1551
"90"	1000	991	1017	"150"	1635	1625	1651
"90" plus	1010	1001	1027	"160"	1735	1725	1751
"100"	1100	1091	1117	"170"	1835	1825	1851
"110"	1200	1191	1217	"180"	1935	1925	1951
"120"	1300	1291	1317	"190"	2035	2025	2051
				"200"	2135	2125	2151
HEIGHT					H _o	H _c	H _d
					2069	2078	2065

S_o - installation opening width
S_s - door frame total width
S_d - width on the door frame external side

H_o - installation opening height
H_d - height on the door frame external side
H_c - door frame total height



ADJUSTABLE METAL DIAGONAL door frame POL-SKONE SYSTEM



In POL-SKONE interior door leaves with a metal door frame and door closer, type T hinges ("60"- "80"- 3 pcs, "90"- "120"- 4 pcs) are used as a standard.



DEDICATED TO
Interior door

COLOURS

Powder-coated door frame.
Standard colours: white (RAL 9003), black (RAL 9005), white (RAL 9016), grey (RAL 7047), brown (RAL 8014), graphite (RAL 7024), beige (NCS S 2005 Y50R)
Other colours from the RAL palette are available at an extra charge - according to the table of extra charges (p.223)

symbol	range in mm	single-leaf door		double-leaf door	
		"60"±"90"	"100" ÷ "120"	"120"±"150"	"160"±"200"
D01	125-155				
D02	155-185				
D03	185-215				
D04	215-245				
D05	245-275				
D06	275-305				
D07	305-335				
D08	335-365				

ACCESSORIES AND EQUIPMENT
(available at an extra charge)

door frame shorter by 50 mm or 100 mm	+10%
door frame higher by 50 mm	+5%
door frame higher by 100 mm	+10%
door frame higher by 150 mm	+15%
door frame higher by 200 mm	+20%
reinforcement for the top-mounted door closer	
additional type M hinge for metal door frame (width "60"±"80") - 1 piece	
change of hinge to type T for the metal door frame (width "60"±"80") - 1 piece	
electric NC strike BIRA F12U (12V AC/DC) including catch plate and adaptation for the electric strike	
electric NO strike BIRA F12R (12V DC) including catch plate and adaptation for the electric strike	
MC 250 mortise reed switch	
MC200-S19 mounting flange for reed switch (white colour) (for metal door frames)	

The door frame made of the highest quality 1.5 mm thick steel sheet.

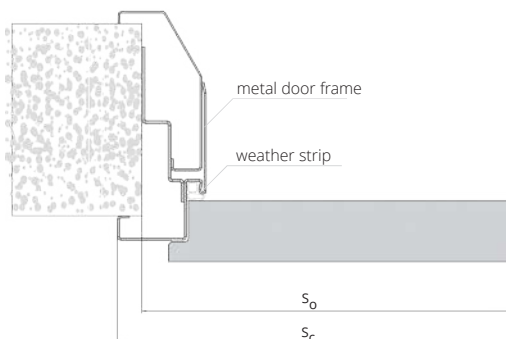

WIDTH									
single-leaf door					double-leaf door				
type	So	Sc	Ho	Hc	type	So	Sc	Ho	Hc
"60"	690	717	2065	2078	"120"	1325	1351	2065	2078
"70"	790	817			"130"	1425	1451		
"80"	890	917			"140"	1525	1551		
"90"	990	1017			"150"	1625	1651		
"90" plus	1000	1027			"160"	1725	1751		
"100"	1090	1117			"170"	1825	1851		
"110"	1190	1217			"180"	1925	1951		
"120"	1290	1317			"190"	2025	2051		
					"200"	2125	2151		

So - installation opening width
Sc - door frame total width

Ho - installation opening height
Hc - door frame total height



ITB- KOT-2021/2046 issue 1

FIXED METAL door frame LUMEN



DEDICATED TO

the LUMEN glass pane

Door frame made of 1.5 mm thick metal sheet.

COLOURS

Powder-coated door frame.

Standard colours: white (RAL 9003), black (RAL 9005), white (RAL 9016), grey (RAL 7047), brown (RAL 8014), graphite (RAL 7024), beige (NCS S 2005 Y50R)

Other colours from the RAL palette are available at an extra charge - according to the table of extra charges (p.223)

door frame type	single-leaf door
FD12 LUMEN	"60"÷"90"

ACCESSORIES AND EQUIPMENT

(available at extra charge)

electric NC strike BIRA F12U (12V AC/DC) including catch plate and adaptation for the electric strike

electric NO strike BIRA F12R (12V DC) including catch plate and adaptation for the electric strike

The installation opening must be enlarged by additional 5 mm for door frames equipped with an electric strike.

FD12 LUMEN

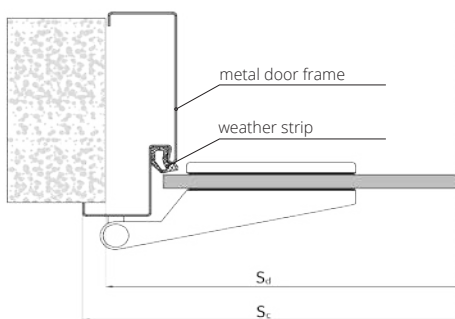

WIDTH FD12 LUMEN

single-leaf door				
type	S _O	S _D	S _C	S _S
"60"	681	671	697	617
"70"	781	771	797	717
"80"	881	871	897	817
"90"	981	971	997	917

HEIGHT	H _D	H _O	H _C	H _S
	2055	2060	2068	2016

S_d - door width on the door frame external side
 S_O - installation opening width
 S_C - door frame total width
 S_S - door leaf width

H_d - door height on the external side of the door frame
 H_O - installation opening height
 H_C - total door frame width
 H_S - door leaf height



ADJUSTABLE METAL door frame LUMEN



DEDICATED TO
the LUMEN glass pane
Door frame made of 1.5 mm thick metal sheet.

COLOURS
Powder-coated door frame.
Standard colours: white (RAL 9003), black (RAL 9005), white (RAL 9016), grey (RAL 7047), brown (RAL 8014), graphite (RAL 7024), beige (NCS S 2005 Y50R)
Other colours from the RAL palette are available at an extra charge - according to the table of extra charges (p.223)

symbol	range mm	single-leaf door "60"÷"90"
ZO1	95-125	
ZO2	125-155	
ZO3	155-185	
ZO4	185-215	
ZO5	215-245	
ZO6	245-275	
ZO7	275-305	
ZO8	305-335	
ZO9	335-365	

**ACCESSORIES
AND EQUIPMENT**
(available at extra
charge)

- additional ZOx adjustment system for the rebated adjustable frame (wall width range increase 635 mm)
- electric NC strike BIRA F12U (12V AC/DC) including catch plate and adaptation for the electric strike
- electric NO strike BIRA F12R (12V DC) including catch plate and adaptation for the electric strike

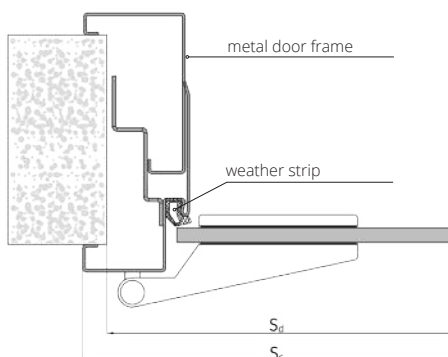

WIDTH FD61 LUMEN				
single-leaf door				
type	S _O	S _D	S _C	S _S
"60"	690	685	717	617
"70"	790	785	817	717
"80"	890	885	917	817
"90"	990	985	1017	917

HEIGHT	H _D	H _O	H _C	H _S
	2062	2065	2078	2016

S_d - door width on the door frame external side
S_O - installation opening width
S_C - door frame total width
S_S - door leaf width

H_d - door height on the external side of the door frame
H_O - installation opening height
H_C - total door frame width
H_S - door leaf height

TUNNELS / WALL CASING SYSTEMS

VERTIGO TUNNEL DOOR FRAME

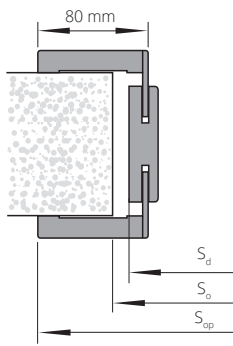

Adjustment range	Range in mm	Complete set of elements Vertical elements	PAINTED* white	PAINTED* grey, beige	BLACK black, sage	UNI MAT PLUS			VENEERED			
						LAMISTONE	SILKSTONE	GROUP A	GROUP B	GROUP C, D		
VT1	76-96	Panel 76 mm, architrave with tongue 32 mm										
VT2	96-116	Panel 76 mm, architrave with tongue 32 mm										
VT3	116-142	Panel 76 mm, architrave with tongue 52 mm										
VT4	142-182	Panel 142 mm, architrave with tongue 32 mm										
VT5	182-208	Panel 142 mm, architrave with tongue 52 mm										
VT6	208-248	Panel 208 mm, architrave with tongue 32 mm										
VT7	248-274	Panel 208 mm, architrave with tongue 52 mm										
VT8	274-314	Panel 274 mm, architrave with tongue 32 mm										
VT9	314-354	Panel 274 mm, architrave with tongue 52 mm										

WIDTH

type	S _d	S _o	S _{op}
"60"	656	680	793
"70"	756	780	893
"80"	856	880	993
"90"	956	980	1093

HEIGHT

	H _d	H _o
	2071	2085

Price excl. VAT - major part of the tunnel casing
* 80 mm wide architraves only

WALL ENCASUREMENT FINISH TUNNEL:
ZN (casing at the on-wall sliding system)
and ZT (opening casing without the door)

Adjustment range	Complete set of elements	ECO TOP	HIGH TOP	LAMISTONE CPL	SILKSTONE	UNI MAT PLUS	for the laminated type	PAINTED* white	PAINTED* grey, beige	BLACK black, sage	VENEERED			
											GROUP A	GROUP B	GROUP C, D	
On-wall system	Tunnel system	Range in mm	Standard dimensions											
ZN 1	ZT 1	76-116	Panel 76 mm, architrave with tongue 32 mm											
ZN 2	ZT 2	116-142	Panel 76 mm, architrave with tongue 52 mm											
ZN 3	ZT 3	142-182	Panel 142 mm, architrave with tongue 32 mm											
ZN 4	ZT 4	182-208	Panel 142 mm, architrave with tongue 52 mm											
ZN 5	ZT 5	208-248	Panel 208 mm, architrave with tongue 32 mm											
ZN 6	ZT 6	248-274	Panel 208 mm, architrave with tongue 52 mm											
ZN 7	ZT 7	274-314	Panel 274 mm, architrave with tongue 32 mm											
ZN 8	ZT 8	314-354	Panel 274 mm, architrave with tongue 52 mm											

EXTRA CHARGES

non-standard height of tunnels (up to 2300 mm)	+30%
double-leaf tunnels dimension "100"+"100"	+50%
double-leaf tunnels dimension "110"+"110"	+70%
DIN AQUA tunnel door frame - subject to consultations with the Sales Department	
"100"; "110"	+20%
architraves interconnected at an angle of 90° (80 mm thick architraves only)	

EXTRA CHARGES for RAL, NCS door frames acc. to the colour groups	GROUP I	GROUP II	GROUP III	GROUP IV	GROUP V
	+20%	+30%	+40%	+60%	+75%

* 80 mm wide architraves only
environment-friendly acrylic paints, RAL and NCS colours (except metallic ones) - available at an extra charge according to the colour groups (p. 264)

ZN, ZN SYSTEM DUO TUNNEL DOOR FRAME (except DIN DUO) (wall casing at the on-wall sliding system)
ZT DIN SYSTEM TUNNEL DOOR FRAME (wall casing without door for DIN door frames)

WIDTH

single-leaf door					double-leaf door				
type	S _d	S _o	S _{op}	S _{op} *	type	S _d	S _o	S _{op}	S _{op} *
"60"	649	670	746	786	"60"+"60"	1282	1305	1379	1419
"70"	749	770	846	886	"70"+"70"	1482	1505	1579	1619
"80"	849	870	946	986	"80"+"80"	1682	1705	1779	1819
"90"	949	970	1046	1086	"90"+"90"	1882	1905	1979	2019
"100"	1049	1070	1146	1186	"100"+"100"	2082	2105	2179	2219

HEIGHT

	H _d	H _o	H _{op}	H _{op} *
	2044	2055	2093	2113

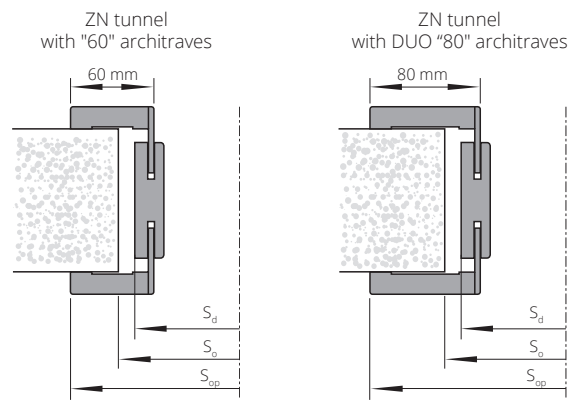

60 mm wide architraves are not available in the painted version

* SYSTEM DUO (except DIN DUO)

S_d - door width on the door frame external side
S_o - installation opening width
S_{op} - width on the external side of the architrave

H_d - door height on the external side of the door frame
H_o - installation opening height
H_{op} - architrave external height

ZT POL-SKONE SYSTEM TUNNEL DOOR FRAME (except ZT DIN)
(wall casing without door)

WIDTH							
single-leaf door				double-leaf door			
type	S _d	S _o	S _{op}	type	S _d	S _o	S _{op}
"60"	700	720	797	"60"+"60"	1334	1360	1431
"70"	800	820	897	"60"+"70"	1434	1460	1531
"80"	900	920	997	"60"+"80", "70"+"70"	1534	1560	1631
"90"	1000	1020	1097	"60"+"90", "70"+"80"	1634	1660	1731
"100"	1100	1120	1197	"70"+"90", "80"+"80"	1734	1760	1831
				"80"+"90"	1834	1860	1931
				"90"+"90"	1934	1960	2031
				"100"+"100"	2134	2160	2231
HEIGHT				H _d	H _o	H _{op}	
				2069	2080	2118	

Available only with the colours of natural veneers

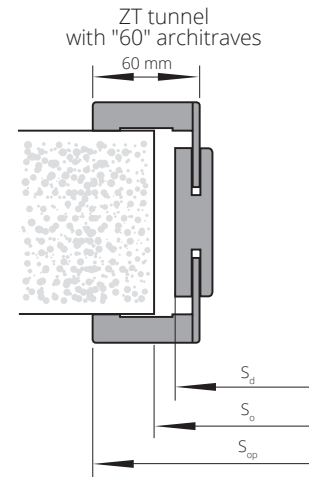

60 mm wide architraves are not available in the painted version

ZT DIN DUO SYSTEM TUNNEL DOOR FRAME
(wall casing without door)

WIDTH							
single-leaf door				double-leaf door			
type	S _o	S _d	S _{op}	type	S _o	S _d	S _{op}
"60"	675	655	792	"60"+"60"	1290	1270	1407
"70"	775	755	892	"60"+"70"	1390	1370	1507
"80"	875	855	992	"60"+"80", "70"+"70"	1490	1470	1607
"90"	975	955	1092	"60"+"90", "70"+"80"	1590	1570	1707
				"70"+"90", "80"+"80"	1690	1670	1807
				"80"+"90"	1790	1770	1907
				"90"+"90"	1890	1870	2007
HEIGHT				H _o	H _d	H _{op}	
				2075	2065	2133	

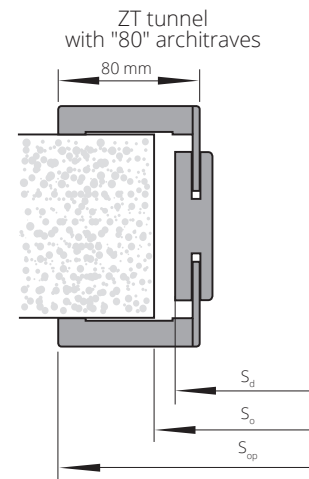

ZT tunnel for SYSTEM DUO door
(wall casing without door)

WIDTH							
single-leaf door				double-leaf door			
type	S _d	S _o	S _{op}	type	S _d	S _o	S _{op}
"60"	699	720	836	"60"+"60"	1326	1350	1463
"70"	799	820	936	"60"+"70"	1426	1450	1563
"80"	899	920	1036	"70"+"70"	1526	1550	1663
"90"	999	1020	1136	"70"+"80"	1626	1650	1763
				"80"+"80"	1726	1750	1863
				"80"+"90"	1826	1850	1963
				"90"+"90"	1926	1950	2063
HEIGHT				H _d	H _o	H _{op}	
				2085	2095	2154	

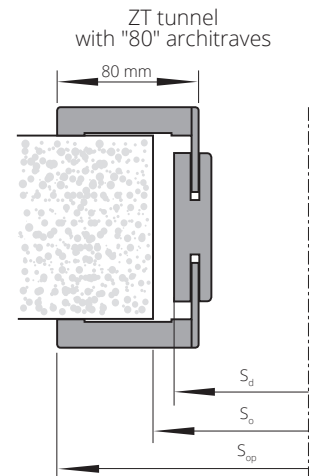

S_d - door width on the door frame external side
S_o - installation opening width
S_{op} - width on the external side of the architrave

H_d - door height on the external side of the door frame
H_o - installation opening height
H_{op} - architrave external height



TOPLIGHTS /SIDELIGHTS FOR DIN/DIN DUO DOOR FRAME

REBATED SYSTEM



**TOPLIGHTS/
SIDELIGHTS
on the DIN door
frame profile**
(price per 1 m of
toplight / sidelight
calculated along the
external perimeter of
the toplight / sidelight)

PAINTED* white	PAINTED* grey, beige	ECO TOP	for the laminated type	VENEERED		
			HIGH TOP	GROUP A	GROUP B	GROUP C, D
			LAMISTONE CPL			
			UNI MAT PLUS			
SILKSTONE						

NP1A	75-85
NP1B	85-95
NP2	95-120
NP3	120-140
NP4	140-160
NP5	160-180
NP6	180-200
NP7	200-220
NP8	220-240
NP9	240-260
NP10	260-280
NP11	280-300

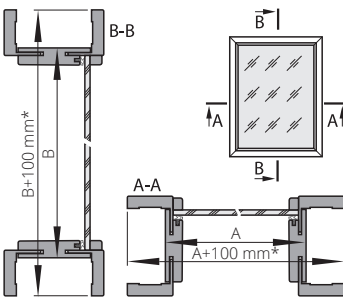

price of sidelight/toplight = price of 1 m x 2(A+B) + price of 1 m² of glass x A x B
optional use of 80 mm architraves

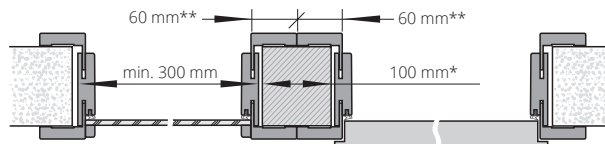

Maximum dimension of toplights and sidelights is:
- toplights AxB= 2190x700 mm
- sidelights AxB= 1000x2043 mm

*When using architraves 80 mm - 140 mm
**When using architraves 80 mm - 80 mm

NON-REBATED SYSTEM



**TOPLIGHTS/
SIDELIGHTS
on the DIN DUO
door frame profile**
(price per
1 m of toplight/sidelight
calculated along the
external perimeter of
the toplight / sidelight)

PAINTED* white	PAINTED* grey, beige	ECO TOP	for the laminated type	VENEERED		
			HIGH TOP	GROUP A	GROUP B	GROUP C, D
			LAMISTONE CPL			
			UNI MAT PLUS			
SILKSTONE						

ND1	75-80
ND2	80-85
ND3	85-95
ND4	95-120
ND5	120-140
ND6	140-160
ND7	160-180
ND8	180-200
ND9	200-220
ND10	220-240
ND11	240-260
ND12	260-280
ND13	280-300

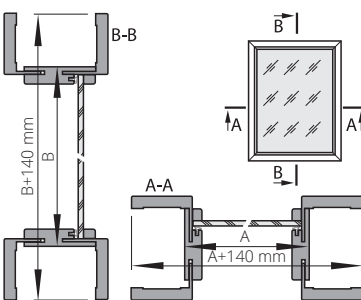

price of sidelight/toplight = price of 1 m x 2(A+B) + price of 1 m² of glass x A x B

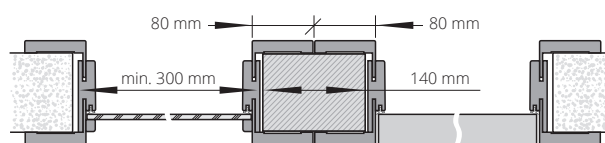

Maximum dimension of toplights and sidelights is:
- toplights SxH = 2207x700 mm
- sidelights SxH = 1000x2133 mm

USE THE B.M. GLASS PANE TYPES FOR TOPLIGHTS: price per 1 m²

- A. Security glass pane, white matt 3.3.1, thickness: 6.4 mm
- B. Security glass pane, transparent 3.3.1, thickness: 6.4 mm
- C. White matt tempered glass pane, thickness: 6 mm
- C. Tempered transparent glass pane, thickness: 6 mm

The architraves of the DIN/DIN DUO toplights are not available with an angle of 90°.

Recommended way of connecting toplights/sidelights along the DIN/DIN DUO door frame by means of installation blocks

*environment-friendly acrylic paints, RAL and NCS colours (except metallic ones) - available at an extra charge according to the colour groups (p. 264)



SIDE PANELS FOR SEMPRE INTERIOR DOORS

TOPLIGHTS/SIDELIGHTS on the POL-SKONE fixed door frame profile (rebated sys.) fixed DUO (non-rebated sys.) (price per 1 m of toplight calculated along the outer perimeter of the toplight)

PAINTED* white	for the laminated type	VENEERED		
	HIGH TOP	GROUP A	GROUP B	GROUP C, D
	UNI MAT PLUS			
	LAMISTONE CPL			
SILKSTONE				

fixed 92 mm

price of sidelight/toplight = price of 1m x 2(A+B) + price of 1m² of glass x A x B

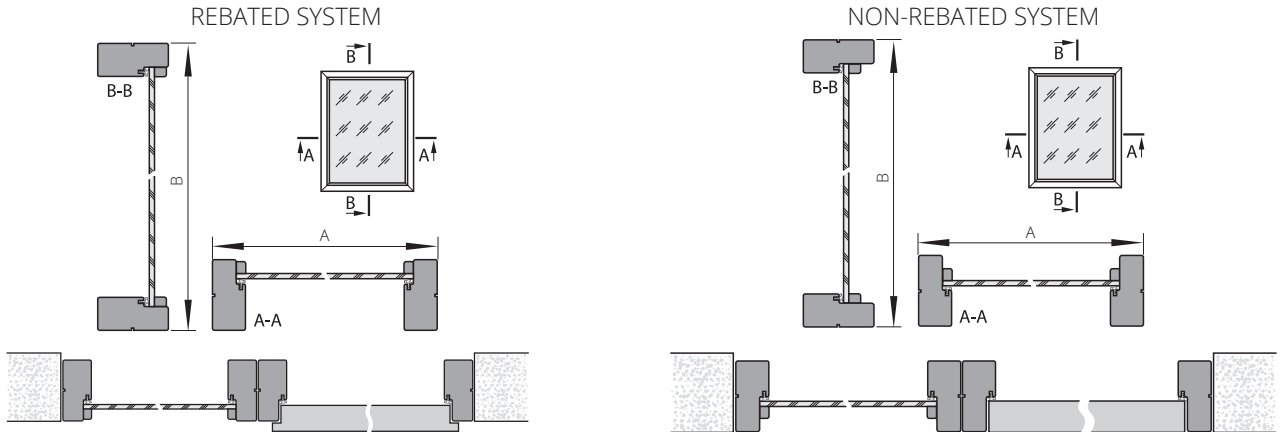

Recommended method of connecting toplights/sidelights on the fixed/DUO fixed door frame profile

*environment-friendly acrylic paints, RAL and NCS colours (except metallic ones) – available at an extra charge according to the colour groups (p. 264)

SEMPRE INTERIOR DOOR SIDE PANELS

PRICE OF DOOR LEAF WITH SIDE PANEL = 2 x DOOR LEAF PRICE

The side panels are applicable to the models: SEMPRE, SEMPRE LUX (patterns W02, W03 only)

WIDTH (rebated system)			WIDTH (non-rebated system)		
type	Ss with rebate	Sds	type	Ss	Sds
"40"+ "70"		431	"40"+ "70"		412
"50"+ "70"	744	531	"50"+ "70"	725	512
"60"+ "70"		631	"60"+ "70"		612
"40"+ "80"		431	"40"+ "80"		412
"50"+ "80"	844	531	"50"+ "80"	825	512
"60"+ "80"		631	"60"+ "80"		612
"40"+ "90"		431	"40"+ "90"		412
"50"+ "90"	944	531	"50"+ "90"	925	512
"60"+ "90"		631	"60"+ "90"		612

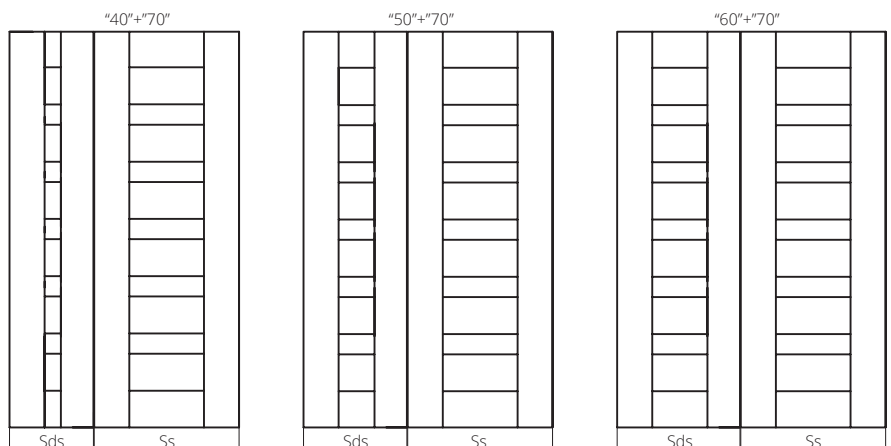

METAL TOPLIGHTS/SIDELIGHTS

To be priced individually subject to consultation with the Sales Department

1 m of toplight/sidelight on the FD18 fixed door frame profile 31

The following glass panes are available for the sidelight / toplight (price per m²):

- white matt 33.1 safe glass pane, thickness 6.4 mm
- transparent 33.1 safe glass pane, thickness 6.4 mm
- white matt safe glass pane, thickness 6 mm
- transparent safe glass pane, thickness 6 mm

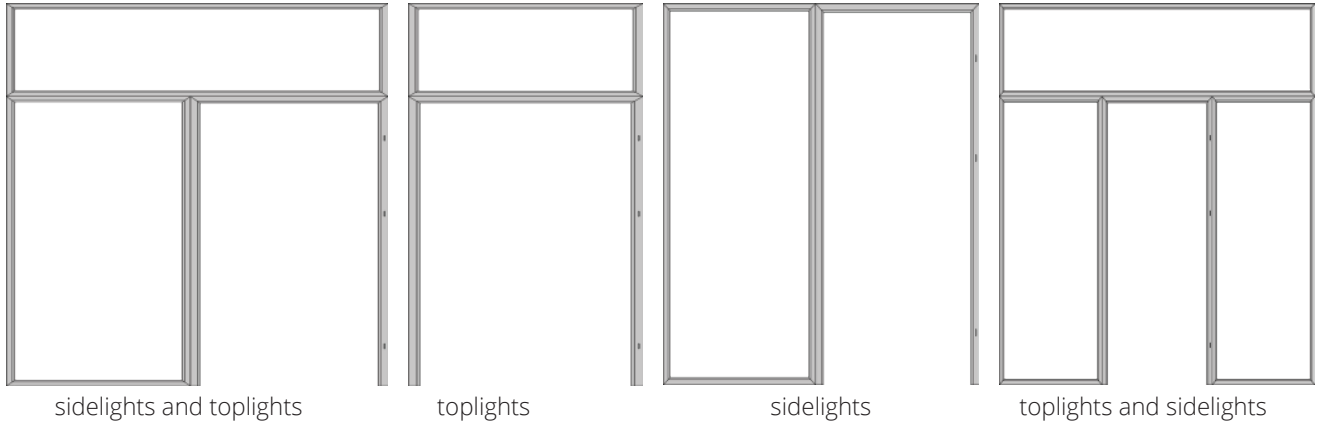

TOPLIGHT/SIDELIGHT CALCULATION METHOD:
price of 1 m x (2 (A+B))+(extra charge for the colour*) + price of 1 m² of glass x AxB

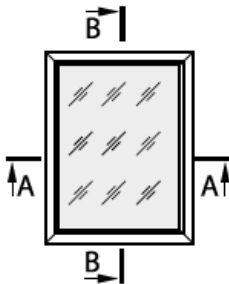

FD18 FIXED METAL DOOR FRAME

dedicated to metal sidelights/toplights

Door frame made of the highest quality 1.5 mm steel sheet

single-leaf type	
"60" - "90"	"100" - "110"
double-leaf type	
"60" - "90"	"100" - "110"

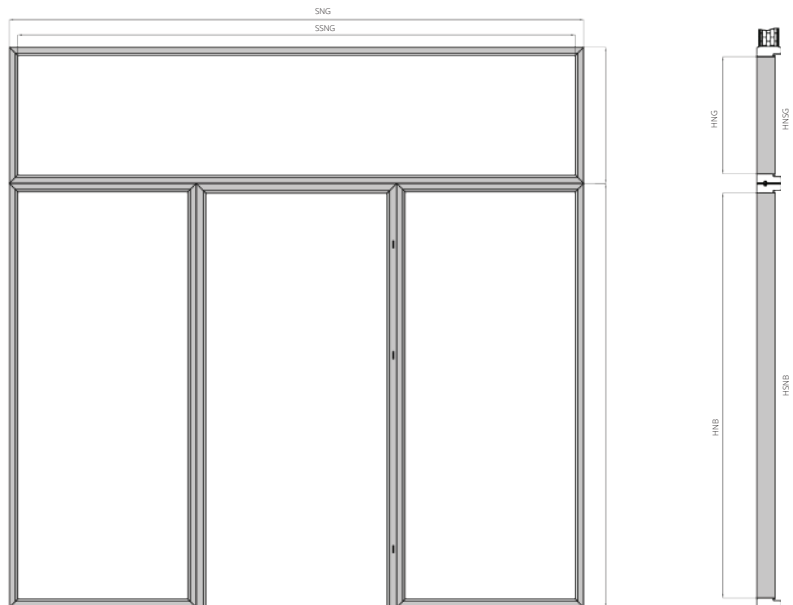

COLOURS

Powder-coated door frame. Standard colours: white (RAL 9003), black (RAL 9005), white (RAL 9016), grey (RAL 7047), brown (RAL 8014), graphite (RAL 7024). Other colours from the RAL palette are available at an extra charge - according to the table of extra charges (p.223)



DEDICATED TO
FD18 fixed metal door frame

COLOURS
Powder-painted toplights / sidelights .
Standard colours: white (RAL 9003), white (RAL 9016), grey (RAL 7047), brown (RAL 8014), graphite (RAL 7024), beige (NCS S 2005 Y50R). Other colours from the RAL palette available at an extra charge - acc. to the table of extra charges.

GLAZING
A toplight / sidelight may be filled with 6 mm tempered glass pane, safe glass pane 33.1 and HDF panel with a thickness of 6 mm.

	DIMENSIONS	
	min [mm]	max [mm]
SSNG	600	2442
SSNB	300	1000
HSNG	300	1000
HSNB	1600	2400
the height of the entire set may not exceed 3300 mm		

SNB - sidelight width
SSNB - width in the sidelight clearance
SSG - toplight width
SSNG - width in the toplight clearance
HNB - sidelight height
HNSG - toplight height
HSNB - height in the sidelight clearance
HSNG - height in the toplight clearance

CONNECTION OF SIDELIGHT/TOPLIGHT TO DOOR FRAME

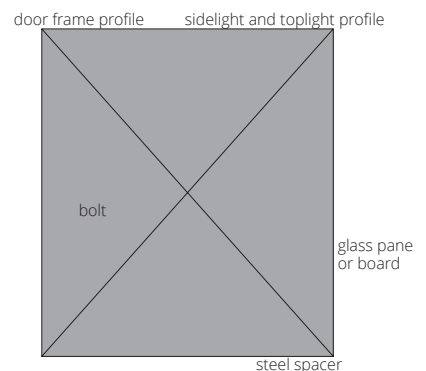

STRIPS

ECO TOP	for the laminated type	PAINTED* white	VENEERED			
	UNI MAT PLUS		GROUP A	GROUP B	GROUP C, D	
	HIGH TOP					
	LAMISTONE CPL					
SILKSTONE	LC1F	LC1F	LC1F	LC10	LC10	LC10

	LC1 OVAL MOULDING	symbol	LC1F	LC1F	LC1F	LC10	LC10	LC10
		for the single-leaf door						
		for the double-leaf door						

	LD6 MASKING MOULDING	symbol	LD6F	LD6F	LD6F	LD60	LD60	LD60
		for the single-leaf door						
		for the double-leaf door						

	LD10 MASKING MOULDING	symbol	LD10F	LD10F	LD10F	LD100	LD100	LD100
		for the single-leaf door						
		for the double-leaf door						

* environment-friendly acrylic paints, RAL and NCS colours (except metallic ones) – available at an extra charge according to the colour groups (p. 264)

Mouldings in the colours of black 244, white 258, Polish oak 276, merbau Royal 295 with a height of 80 mm available from the stock

RECOMMENDED CONNECTIONS OF MOULDINGS

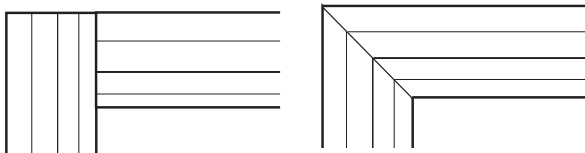

LD10
complete set for the double-leaf door: 2 strips with a length of 2200 mm + 1 strip with a length of 1150 mm;
complete set for double-leaf door: 3 strips with a length of 2200 mm;

LC1, LD6
complete set for the double-leaf door: 2 strips with a length of 2150 mm + 1 strip with a length of 1150 mm;
complete set for double-leaf door: 3 strips with a length of 2150 mm

BASEBOARDS

moulding width 80 mm

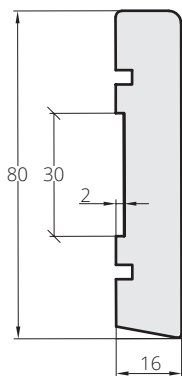

moulding width 100 mm

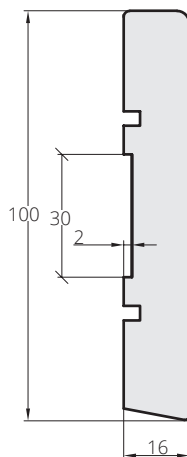

STRIP	PAINTED* white	UNI MAT PLUS	VENEERED		
		LAMISTONE	GROUP A	GROUP B	GROUP C, D
		SILKSTONE			

price per 1 m of moulding

width: 80 mm

width: 100 mm

EXTRA CHARGES for RAL, NCS door frames acc. to the colour groups*	GROUP I	GROUP II	GROUP III	GROUP IV	GROUP V
	+20%	+30%	+40%	+60%	+75%

* environment-friendly acrylic paints, RAL and NCS colours (except metallic ones) – available at an extra charge according to the colour groups (p. 264)

Baseboards available as 2.6 m long elements.

Minimum order volume for a single colour is 5 elements (1 package).



Skirting board made of moisture-proof board

SLIDING system FOR IN-WALL INSTALLATION

EQUIPMENT	
hook lock (chrome) for the privacy lock	
system brushes	
door leaf alone for the sliding system	+ pull handle price
change of lock to privacy lock (WC) with key	
cassettes for the in-wall sliding door system*	
handles for sliding door for in-wall installation	p. 250
SP60 closer** for the single-leaf door	
decelerator SP60** for double-leaf door	
single cassette (100 or 125 mm)	
leaf dimensions	
"60" (G/60)	
"70" (G/70)	
"80" (G/80)	
"90" (G/90)	
"100" (G/100)	
extra charges	
cassette higher by 100 mm Ho=2175 mm	+50% to the single cassette price
cassette higher by 200 mm Ho=2275 mm	+50% to the single cassette price

for the synchronisation system (simultaneous opening system) in double-leaf door

*cassettes for the in-wall sliding door system (the minimum thickness of the single or double cassette with the drywall casing is: 100 mm for flat leaves; 125 mm for door leaves with a decor and glazed with frames)

**Use of the SP60 decelerator for the system hidden in the wall:
- single-leaf door, width "60" - "100"
- double-leaf door, width "60" + "60" - "90" + "90" without the simultaneous closing synchronisation of door leaves or double-leaf door, width "80" + "80" - "90" + "90" with simultaneous closing synchronisation of door leaves. Due to the specific installation procedure, the SP60 decelerator cannot be used in the following door models: ETIUDA/ETIUDA LUX - A02, A03; PASSO; ESTADO/ESTADO LUX - A02, A03

Lack of symmetry in doors with pattern/decoration

Casing and cassette higher by 100 mm and 200 mm are available on request. A non-symmetrical casing is available subject to consultation with the Sales Department.

SLIDING DOOR FOR CASING, RIGHT-HAND / LEFT-HAND SYMMETRICAL

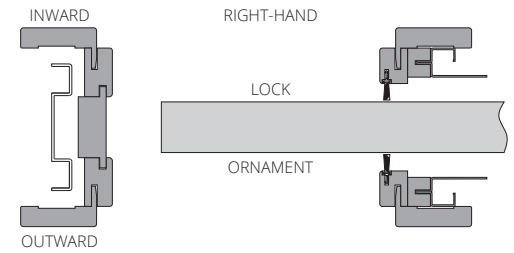

double cassette (100 or 125 mm)	
leaf dimensions	
"60"+"60" (GG/60)	
"70"+"70" (GG/70)	
"80"+"80" (GG/80)	
"90"+"90" (GG/90)	
"100"+"100" (GG/100)	
auxiliary products	price [1 piece]
white brush SB 01	
black brush SB 03	



door in the SLIDING SYSTEM FOR IN-WALL CASING

SLIDING SYSTEM FOR IN-WALL CASING

Price of casing system = price of selected door leaf + price of cassette + price for complete in-wall casing set for single-leaf door acc. to the below tables.
 Price of DUO casing system = price of selected door leaf + price of cassette + price for complete in-wall casing set for single-leaf door acc. to the below tables.

Complete in-wall casing system for single-leaf doors for a 100 mm cassette.

For door leaves: ARCO, ETIUDA, ETIUDA LUX, MODERN, INTERSOLID II, SEMPRE, SEMPRE LUX, FORTIMO, FORTIMO LUX, SONATA, ESTATO, FIORI, SEDO, EGRO, VERI, MODO, SUBITO, INTER-AMBER, IMPULS, SIMPLE, FIORD, DECO LUX, SUBLIME, HAPTIC, ESTADO LUX, TIARA, CAMBIO, DECO, ESPINA, MONA, PASSO, MODESTO, SAMOS, UNITO, ARIA, TEO, ESTO, ZENN

single-leaf door	ECO TOP	PAINTED* white	PAINTED* beige, grey	for the laminated type	VENEERED		
				HIGH TOP			
				LAMISTONE CPL			
				SILKSTONE			
range in mm				UNI MAT PLUS	GROUP A	GROUP B	GROUP C, D
100-106							

Variant I - Table I

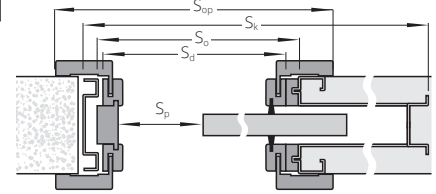

Complete in-wall casing set for single-leaf doors for a 125 mm cassette (flush or glazed versions)

For door leaves: ARCO, INTER-AMBER, IMPULS, ETIUDA, ETIUDA LUX, DECO, SIMPLE, FIORD, CAMBIO, MODERN, SEMPRE, SEMPRE LUX, INTERSOLID II, FORTIMO, FORTIMO LUX, SONATA, SUBLIME, ESTADO, FIORI, ESTADO LUX, VILANO, HAPTIC, TIARA, VERTIGO, DECO LUX, ESPINA, MONA, PASSO, SEDO, CREATO, EGRO, VERI, MODO, SUBITO, MODESTO, SAMOS, UNITO, ARIA, TEO, ESTO, ZENN

single-leaf door	ECO TOP	PAINTED* white	PAINTED* beige, grey	for the laminated type	VENEERED		
				HIGH TOP			
				LAMISTONE CPL			
				SILKSTONE			
range in mm				UNI MAT PLUS	GROUP A	GROUP B	GROUP C, D
125-140							
140-160							
160-180							
180-200							
200-240							
240-280							
280-320							

Variant II - Table II

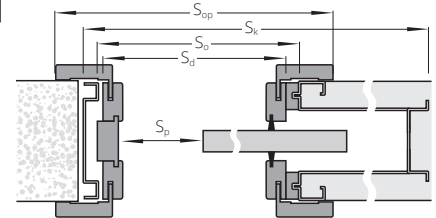

Complete in-wall casing system for single-leaf doors for a 125 mm cassette (door leaf with decoration)

For door leaves: INTERSOLID, NOSTRE, INVERNO, MAESTO

single-leaf door	ECO TOP	PAINTED* white	PAINTED* beige, grey	for the laminated type	VENEERED		
				HIGH TOP			
				LAMISTONE CPL			
				SILKSTONE			
range in mm				UNI MAT PLUS	GROUP A	GROUP B	GROUP C, D
125-131							
131-140							
140-160							
160-180							
180-200							
200-220							
220-260							
260-300							

Variant III - Table III

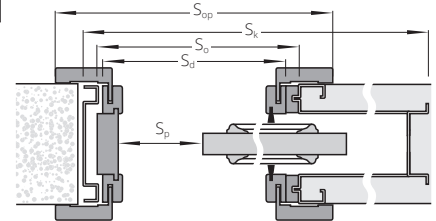

EXTRA CHARGES

for the double-leaf door	+50%
width "100"	
architraves interconnected at an angle of 90°	

RAL and NCS colours (except the metallic ones) - available at an extra charge acc. to the table for particular door leaf models.

WIDTH

single-leaf door Dimensions on the external side: of door leaves (Ssb, Hsb), doors (Sd, Hd)							double-leaf door Dimensions on the external side: of door leaves (Ssb, Hsb), doors (Sd, Hd)						
TABLE I, II, III													
type	Ssb	Sd	So	Sk	Sp	Sop	type	Ssb	Sd	So	Sk	Sp	Sop
"60"	644	625	650	1307	510	725	"60"+"60"	1288	1216	1250	2520	1030	1316
"70"	744	725	750	1507	610	825	"70"+"70"	1488	1416	1450	2920	1230	1516
"80"	844	825	850	1707	710	925	"80"+"80"	1688	1616	1650	3320	1430	1716
"90"	944	925	950	1907	810	1025	"90"+"90"	1888	1816	1850	3720	1630	1916
"100"	1044	1025	1050	2107	910	1125							
HEIGHT								Hsb	Hd	Ho	Hk	Hp	Hop
								2033	2038	2075	2125	2016	2088

Ssb - door leaf external width
 Sd - door frame external width
 So - door frame installation opening width
 Sk - cassette external width
 Sp - clear opening width
 Sop - width on the external side of the architrave
 Hsb - door leaf external height
 Hd - height on the door frame external side
 Ho - door frame installation opening height
 Hk - height on the cassette external side
 Hp - clear opening height
 Hop - architrave external height

SLIDING ON-WALL system

EQUIPMENT, ON-WALL SYSTEM

standard:
long brass pull handle chrome satin (U4) p. 250

optional:

pull handles or hook lock
SP60 closer* for the single-leaf door p. 250
SP60 decelerator* for double-leaf door
BIAS decelerator for single-leaf door
BIAS decelerator for double-leaf door

*Use of the SP60 decelerator for the on-wall system:
- single-leaf door, width "60" - "100"
- double-leaf door, width "60" + "60"; "90" + "90"
Due to the specific installation procedure, the SP60 decelerator cannot be used in the following door models: ETIUDA/ETIUDA LUX - A02, A03; PASSO; ESTADO/ESTATO LUX - A02, A03;

in glazed door - ornament on the outside,
in door with lock - privacy lock on the inside.

In double-leaf door:
right-hand - lock in the right door leaf;
left-hand - lock in the left door leaf.

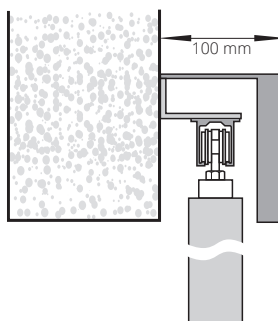

sliding on-wall system
(MDF masking strip made in the colour of the door leaf)

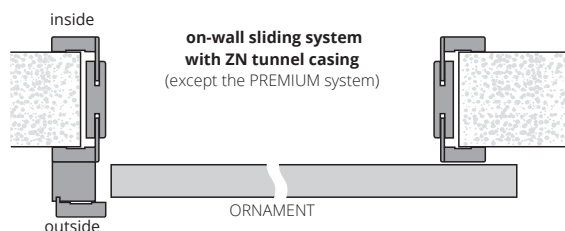

LENGTHS OF MASKING STRIPS FOR THE ON-WALL SYSTEM

"60" - 1795 mm	"60"+"60" - 3448 mm*
"70" - 1795 mm	"70"+"70" - 3448 mm*
"80" - 1795 mm	"80"+"80" - 3448 mm*
"90" - 2045 mm	"90"+"90" - 3948 mm*
"100" - 2295 mm	

* The masking strip is combined of two elements; the masking strip height 110 mm



on-wall system guide rail



masking strip and stop post of the on-wall system



door in the ON-WALL SLIDING system

ON-WALL SYSTEM

the price includes: the guide, the masking strip and stop post *

single-leaf door	PAINTED** white	PAINTED** grey, beige	BLACK black, sage	ECO TOP	for the laminated type	VENEERED		
					HIGH TOP	GROUP A	GROUP B	GROUP C, D
					LAMISTONE CPL			
					SILKSTONE			
					UNI MAT PLUS			
wood-like film		wood-like laminate						
extra charge added to a selected model of interior leaf								
"60"- "90"								
"100"								

EXTRA CHARGES

for the double-leaf door	+50%
door lower by 50 mm	+20%
door higher by 50 mm or 100 mm	+10%
door higher by 150 mm or 200 mm	+20%
architraves interconnected at an angle of 90° (only 80 mm architraves)	
architraves with a width of 80 mm (except PAINTED)	+30%
ventilation option	p. 245

* optionally available: version with the wall casing system ("finishing tunnel") – the price depends on the wall thickness

** colours of the RAL, NCS system - extra charge required according to colour chart; door leaf for sliding on its own is available (extra charge + 13) + price of handle

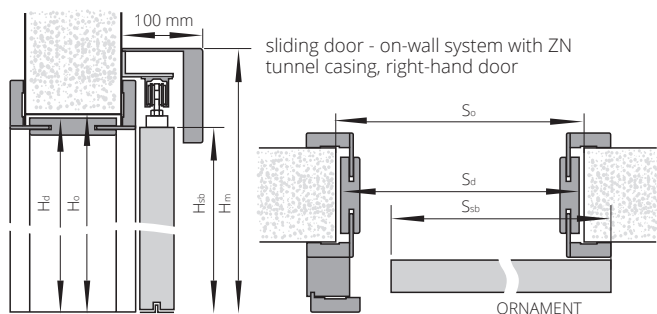
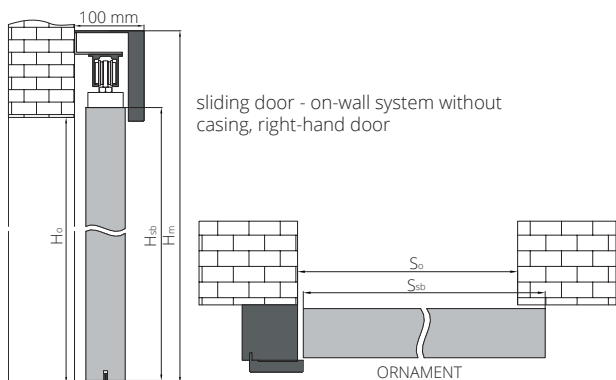

For the on-wall system, we recommend the ZN tunnel casing (p. 232).

If tunnel casing with 80 mm architraves is used, the lintel architrave must be trimmed by the customer during installation.

WIDTH					
single-leaf door dimensions on the external side of leaves (S _{sb} , H _{sb}) and of the installation opening (S _o , H _o)			double-leaf door (without an approach post) dimensions on the external side of door leaves		
type	S _{sb}	S _o	type	S _{sb}	S _o
"60"	644	620	"60"+"60"	1288	1240
"70"	744	720	"70"+"70"	1488	1440
"80"	844	820	"80"+"80"	1688	1640
"90"	944	920	"90"+"90"	1888	1840
"100"	1044	1020			

HEIGHT			
	H _o	H _{sb}	H _{fm}
	2020	2033	2138

WIDTH							
single-leaf door dimensions on the external side of door leaves (S _{sb} , H _{sb}) and installation opening (S _o , H _o)				double-leaf door (without an approach post) dimensions on the external side of door leaves (S _{sb} , H _{sb}) and installation opening (S _o , H _o)			
type	S _{sb}	S _o	S _d	type	S _{sb}	S _o	S _d
"60"	644	670	649	"60"+"60"	1288	1305	1282
"70"	744	770	749	"70"+"70"	1488	1505	1482
"80"	844	870	849	"80"+"80"	1688	1705	1682
"90"	944	970	949	"90"+"90"	1888	1905	1882
"100"	1044	1070	1049				

HEIGHT				
	H _o	H _d	H _{sb}	H _{fm}
	2055	2044	2033	2138

SLIDING ON-WALL PREMIUM system

EQUIPMENT ON-WALL PREMIUM SYSTEM

standard: longitudinal pull handle in the colour of chrome-satin (U4)	p. 250
optional: pull handles for sliding leaves	p. 250

PREMIUM ON-WALL SYSTEM

the price includes: the masking strip and the guide rail (elements made of aluminium)
for single-leaf door
for double-leaf door
door leaf for sliding on its own isn available (extra charge) + price of handle

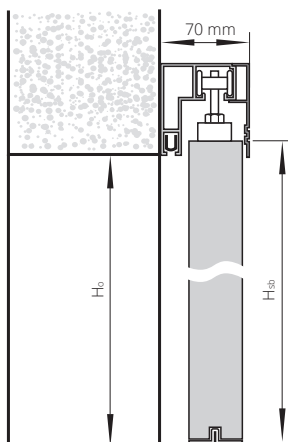

LENGTHS OF MASKING STRIPS FOR ON-WALL PREMIUM SYSTEM

"60"	1800 mm
"70"	1800 mm
"80"	1800 mm
"90"	2000 mm
"60"+"60"	1800 + 1800 mm
"70"+"70"	1800 + 1800 mm
"80"+"80"	1800 + 1800 mm
"90"+"90"	2000 + 2000 mm

Hm - height on the masking strip external side
Ho - installation opening height
Hsb - height on the door leaf external side
Hd - height on the door frame external side
So - installation opening width
Ssb - width on the door leaf external side
Sd - door frame external width

WIDTH

single-leaf door dimensions on the external side of door leaves (Ssb, Hsb) and installation opening (So, Ho)			double-leaf door dimensions on the external side of door leaves (Ssb, Hsb) and installation opening (So, Ho)		
type	S _{sb}	S _o	type	S _{sb}	S _o
"60"	644	620	"60"+"60"	1288	1240
"70"	744	720	"70"+"70"	1488	1440
"80"	844	820	"80"+"80"	1688	1640
"90"	944	920	"90"+"90"	1888	1840

height: (Hsb) 2033, (Ho) 2020, height from the floor level to the masking strip upper edge - 2103 mm



door in the SLIDING ON-WALL PREMIUM system

SLIDING ON-WALL MOVI system



LEAF STRUCTURE

Non-rebated system door leaf The door is made of a **wooden rail and stile set** topped with two plain HDF boards with the ECO TOP, LAMISTONE CPL and SILKSTONE surface, laminated, veneered and painted.
The standard in-fill is a honeycomb-like layer. The rated door leaf thickness is 40 mm.

DOOR LEAF FINISH

Smooth painted, veneered, laminated surfaces or with ECO TOP, LAMISTONE CPL, SILKSTONE finishes.

EQUIPMENT

STANDARD:

U4 longitudinal handrail chrome satin

OPTIONALLY:

solid chipboard in-fill

door leaf lower by 50 mm without an extra charge

door leaf higher by 50 mm + 5%

door leaf higher by 100 mm + 10%

door leaf higher by 150 mm + 15%

door leaf higher by 200 mm + 20%

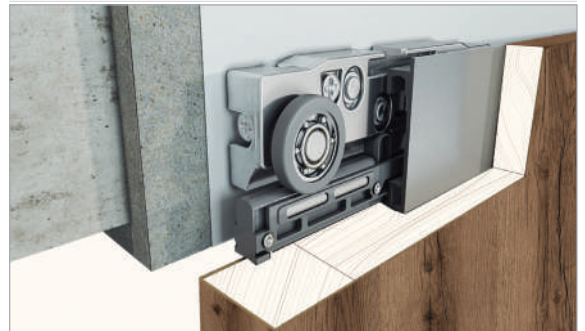

There is no tunnel casing available for the MOVI sliding system.

Price of complete MOVI system price = price of MOVI door leaf + price of MOVI sliding system price

MOVI SLIDING SYSTEM

door leaf width
"70" - "100"
"110"

LEAF FOR MOVI SLIDING SYSTEM

door leaf width	ECO TOP	LAMISTONE CPL SILKSTONE UNI MAT PLUS	LAMINATED CPL 0.2 mm	PAINTED white	PAINTED grey, beige	BLACK black, sage	VENEERED			ESPINA	
							GROUP A	GROUP B	GROUP C, D	GROUP A	GROUP B

"70" - "90"

"100" - "110"

closed

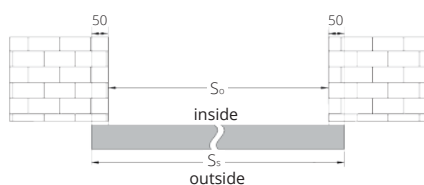

opened (left-hand door)

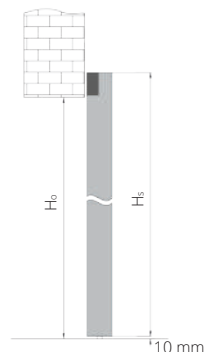
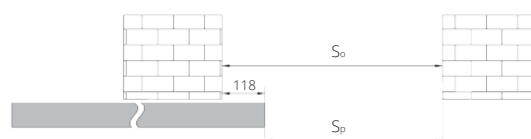

WIDTH

dimension	S _S	S _O	S _D
"70"	744	644	526
"80"	844	744	626
"90"	944	844	726
"100"	1044	944	826
"110"	1144	1044	926

HEIGHT

dimension	H _S	H _O
door leaf lower by 50 mm	2040	1980
standard leaf	2090	2030
door leaf higher by 50 mm	2140	2080
door leaf higher by 100 mm	2190	2130
door leaf higher by 150 mm	2240	2180
door leaf higher by 200 mm	2290	2230

S_s - door width
S_o - installation opening width
S_p - clear opening width
H_s - door leaf height
H_o - installation opening height

VENTILATION OPTIONS

	Plastic tubes T1-T4, T10, T13-T15	Plastic tubes T240-T243, T258, T260, T263, T276	Plastic tubes T120, T258, T121, T132, T141, T276, T295	Plastic tubes T293-T297	standard/DUO ventilation undercut	SEMPRE ventilation undercut	ARCO ventilation undercut	FORTIMO /MONA ventilation undercut	double slot ventilator	triple slot ventilator	plastic grill	stainless steel grill	bottom rail and stile set moisture protector*	NOTES
ARCO, SEDO, VERI, MODO, EGRO INTER-AMBER	X		X ²	X ²	X		X ¹		X		X	X	X	1) undercut only for widths "80", "90" 2) in width "60" - 3 tubes as a standard
IMPULS, NOSTRE, INVERNO, SONATA (W1, W2, W5, W7)	X	X		X	X				X		X	X	X	
SONATA (W4, W6)	X	X		X	X				X		X ¹	X ¹	X	1) ventilation grill only in the standard height version
IMPULS 13	X	X		X	X						X ¹	X ¹	X	1) ventilation grill only for widths "70", "80", "90"
ETIUDA A01, B1	X	X		X	X						X ¹	X ¹	X	1) only for widths "70", "80", "90"
ETIUDA B0	X	X		X	X				X		X	X	X	
ESTATO B2, B3	X				X								X	
ETIUDA LUX A01, B1 ESTATO A01, B1, CREATO A01	X				X						X ¹	X ¹	X	1) only for widths "70", "80", "90"
ETIUDA LUX B0	X				X				X		X	X	X	
DECO	X	X			X				X		X	X	X	
INTERSOLID, INTERSOLID II	X				X						X ¹	X ¹	X	1) ventilation grill only in the standard height version
MODERN, MODENA	X				X				X		X ¹	X ¹	X	1) ventilation grill only for the standard height
DECO LUX, CAMBIO, SIMPLE, TIARA (W01, W02, W05, W07), SUBLIME	X				X				X		X	X	X	
ESPINA	X				X				X ¹		X	X	X	1) except the W01 pattern
FIORD, TIARA (W03, W04, W06), VERTIGO, VILANO	X				X				X		X ¹	X ¹	X	1) ventilation grill only for the standard height
LUMEN					X									
PASSO					X									
FOLDING DUO	X	X	X	X										
SONATA LUX, SEMPRE LUX							X ¹			X ¹				1) only in widths "80", "90" 2) in width "60" - 3 tubes as a standard
SEMPRE ³		X ²					X ¹			X ¹				1) only for widths "80", "90" 2) in width "60" - 3 tubes as a standard 3) except patterns W05, W07
FORTIMO		X ²		X ²				X ¹		X ¹				1) undercut only for widths "80", "90" 2) in width "60" - 3 tubes as a standard
FORTIMO LUX								X ¹		X ¹				1) undercut only for widths "80", "90" 2) in width "60" - 3 tubes as a standard
ESTATO LUX A01	X				X						X ¹	X ¹		1) only in widths "70", "80", "90"
HAPTIC					X				X		X	X	X	
TIARA W08 SONATA W8	X			X	X								X	
MONA		X						X ¹		X ¹				1) trim only in widths "80", "90"
ETIUDA, ETIUDA LUX, ESTATO, ESTATO LUX, CREATO (WZORY A02, A03),					X ¹									1) only in widths "70", "80", "90" PATTERNS A02, A03
FIORI	X	X					X ¹							1) trim only with the "80" and "90" width
LOFTY	X	X	X	X	X				X		X	X	X	

*except door leaves with ventilation undercut
The ventilation options for the DUO collection are to be applied as for the relevant door models

Door width	Door with ventilation undercut		Door with ventilation tubes		Door with two rows of ventilation tubes	
	Total cross-section of ventilation holes with the 10 mm clearance [m ²]	Total cross-section of tubes and standard 10 mm clearance [m ²]	An additional clearance between door leaf lower edge and floor is required to fulfill requirements of the regulation* [mm]	Total cross-section of tubes and standard 10 mm clearance [m ²]	An additional clearance between door leaf lower edge and floor is required to fulfill requirements of the regulation* [mm]	
REBATED	"60"	0.019	0.009	25**	0.011	20**
	"70"	0.022	0.010	20**	0.012	15**
	"80"	0.026	0.011	15**	0.013	15**
	"90"	0.029	0.012	15**	0.014	10**
	"100"	0.033	0.013	10**	0.015	10**
"110"	0.036	0.014	10**	0.016	10**	
DUO (NON-REBATED)	"60"	0.016	0.009	25**	0.011	20**
	"70"	0.020	0.010	20**	0.012	15**
	"80"	0.024	0.011	15**	0.013	15**
	"90"	0.028	0.012	15**	0.014	10**
	"100"	0.032	0.013	10**	0.015	10**
"110"	0.036	0.014	10**	0.016	10**	
LUMEN	"60"	0.015	-	-	-	-
	"70"	0.019	-	-	-	-
	"80"	0.023	-	-	-	-
	"90"	0.027	-	-	-	-
ARCO	"60"	0.017	-	-	-	-
	"70"	0.021	0.010	20**	-	-
	"80"	0.026	0.011	15**	-	-
	"90"	0.030	0.012	15**	-	-
	"100"	0.034	0.013	10**	-	-
SEMPRE	"60"	0.014	0.009	25**	-	-
	"70"	0.018	0.010	20**	-	-
	"80"	0.023	0.011	15**	-	-
	"90"	0.027	0.012	15**	-	-
	"100"	0.032	0.014	10**	-	-
FORTIMO	"60"	0.016	0.009	25**	-	-
	"70"	0.020	0.010	20**	-	-
	"80"	0.024	0.011	15**	-	-
	"90"	0.028	0.012	15**	-	-

The standard clearance between the door leaf and the floor is 10 mm.

* According to the Regulation of the Minister of Infrastructure of 12 April 2002 on the technical conditions which must be fulfilled by buildings and their location. (Journal of Laws, 75 of 2002, item 690 as amended, Journal of Laws, no 33 of 2003, item 270, Journal of Laws no 109 of 2004, item 1156), Chapter 6, §. 79. "A bathroom, washroom and separate toilet door should be opening outwards, have, subject to § 75 section 2, at least 0.8 m and a height of 2 m within the door frame clearance and - in the lower part - air inlet holes with a total cross-section area not smaller than 0.022 m²."

** it is required to increase the clearance by the specific value by shortening the door leaf from the bottom side when the shortening is possible. Shortening the door in a do-it-yourself manner will cause the warranty to be invalid.

Door leaves unavailable for shortening:
- Etiuda, Etiuda Lux patterns A1-A3
Sliding door have a structural design (set away from wall/ on-wall system by about 20mm) that allows it to comply with the regulation without the need to add a ventilation undercut or ventilation tubes.
The ventilation grills and the stainless steel panels with ventilation surface comply with the regulation.

VENTILATION OPTIONS

Ventilation undercut dyed in the colour similar to the door leaf, protected with moisture-proof impregnant

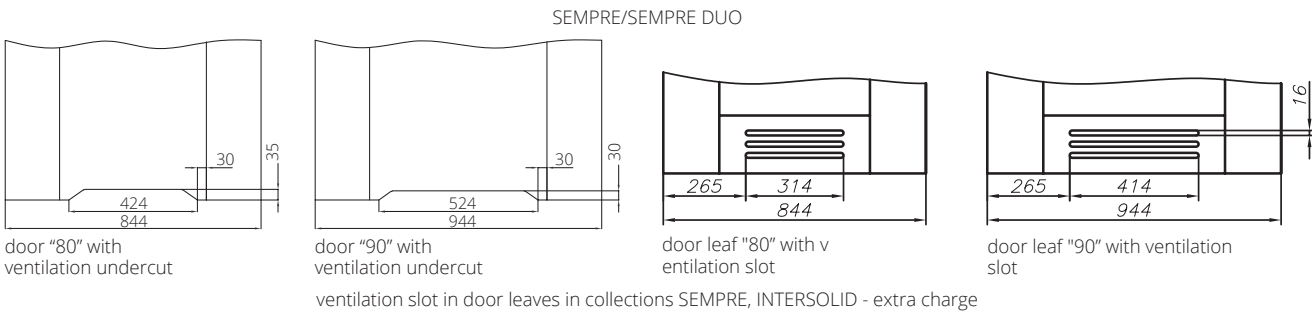
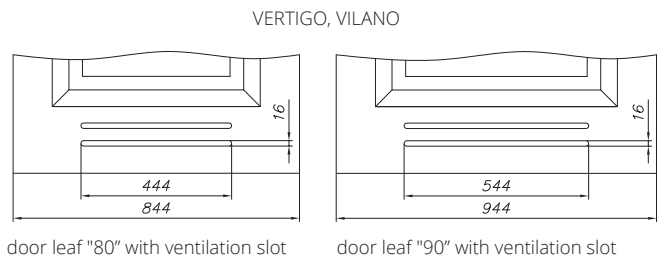
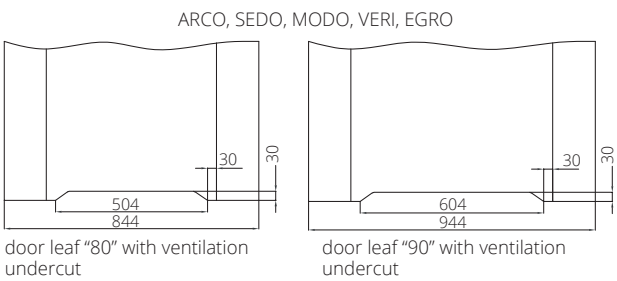
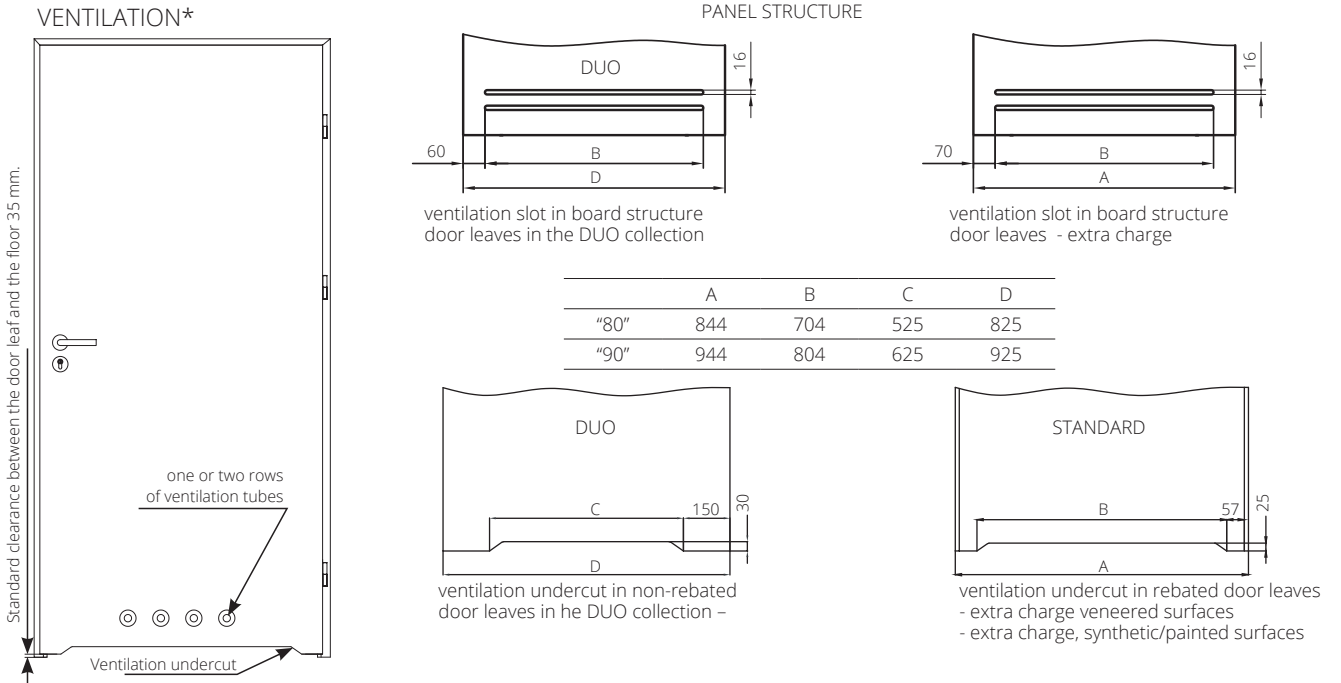

IMPULS 13, ESTATO, ESTATO LUX, CREATO, ETIUDA, ETIUDA LUX "80" (versions A01-A03 only)
rebated version

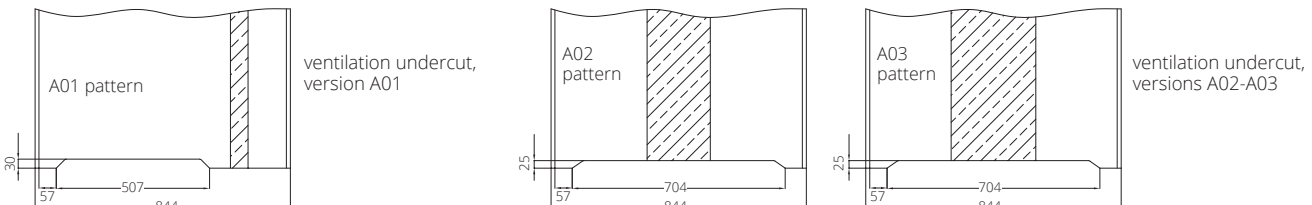

non-rebated version

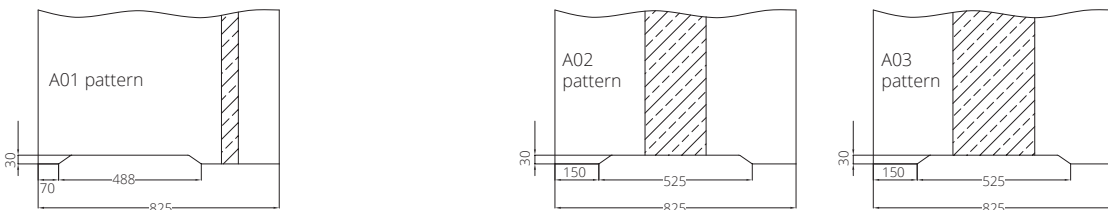

Standard clearance between the door leaf and floor is 10 mm.

* According to the Ordinance of the Minister of Infrastructure of 12 April 2002 on the technical conditions which must be fulfilled by buildings and their location. (Journal of Laws, 75 of 2002, item 690 as amended, Journal of Laws no 33 of 2003, item 270, Journal of Laws no 109 of 2004, item 1156), Chapter 6, §. 79. "A bathroom, washroom and separate toilet door should be opening outwards, have, subject to § 75 section 2, at least 0.8 m and a height of 2 m within the door frame clearance and - in the lower part - air inlet holes with a total cross-section area not smaller than 0.022 m²".

** increase the clearance by the specific value by shortening the door leaf from the bottom side in case when shortening is possible.

Door leaves unavailable for shortening: Etiuda, Etiuda Lux patterns A1-A3.

Sliding door leaves comply with the regulation without the need to add a ventilation undercut or ventilation tubes due to their structural design (set away from wall/tunnel by about 20 mm).

VENTILATION OPTIONS

VENTILATION TUBES made of plastic (a complete set 4 pcs)



VENTILATION TUBES made of plastic (a complete set 4 pcs) - designed to match the door leaf colour

HIGH TOP



T292
coffee ash

row of tubes (4 pcs)

ECO TOP



T121
oak

T132
walnut

T120/T258
white

T161
half oak

T141
Salinas oak

T276
honey
oak

LAMISTONE



T258
white

T260
white oak

T263
premium walnut

T240
whitewashed
elm

T241
sand elm

T242
grey elm

T243
delano oak

T250
terra oak

T276
Polish oak

SILKSTONE

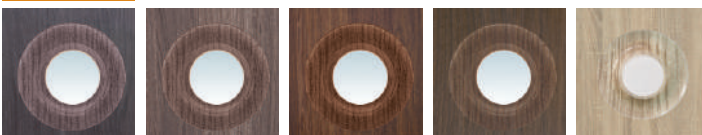

T293
Royal anthracite

T294
Royal ash

T295
Royal merbau

T297
Royal nougat

T230
gran oak

The actual colours may vary from the colours printed in this catalogue.

The ventilation tubes do not fulfil the requirements of the Ministerial regulation concerning the cumulative cross-section of the holes for air supply.

VENTILATION OPTIONS

CROSS RAIL WITH VENTILATION SURFACE



- extra charge "70"
- extra charge "80"
- extra charge "90", "90 plus"
- extra charge "100"
- extra charge "110"

VENTILATION TUBES*

made of plastic



white

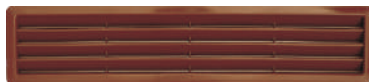

brown



black



beige



grey



anthracite

white, beige, brown, grey, black, anthracite

made of stainless steel

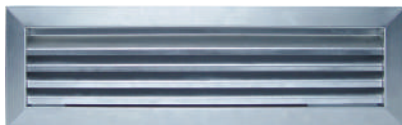

H17 clip fastening
acid resistant, clip fastening

Stainless steel grills and panels are optionally available on request.
The area of air inflow holes is more than 0.022 m².

* In accordance with the Announcement of the Minister of Development and Technology of 15 April 2022 (Journal of Laws 2022, item 1225) on the announcement of the consolidated text of the Regulation of the Minister of Infrastructure on the technical conditions to be met by buildings and their location: Chapter 6, §. 79. "A bathroom, washroom and separate toilet door should be opening outwards, have, subject to § 75 section 2, at least 0.8 m and a height of 2 m within the door frame clearance and - in the lower part - air inlet holes with a total cross-section area not smaller than 0.022 m²".

STAINLESS STEEL PROTECTORS

WITH THE 0.6 MM THICK EDGE OF DOOR LEAF

rebated system only

Door leaf vertical edge protectors can be used for a 40 mm thick door leaf in coatings LAMISTONE, SILKSTONE, CPL 0,2; CPL 0,5; CPL 0,7 and VENEERED. Protectors are only suitable for type T hinges.

PROTECTOR TYPE

(vertical protector of the lock side and vertical protector of the hinge side)

extra charge added to the door leaf catalogue price

Complete set of protectors for the 40 mm thick door leaf

In case of swing doors, the leaf edge protector is installed on the side opposite to the hinge side.

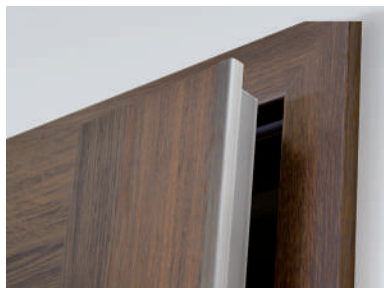

PORTHOLES

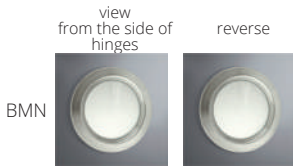
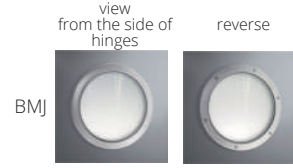
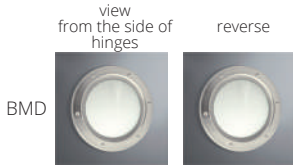

size	S ₀	colour
porthole 1 (Ø 240 mm, thickness: 18, 40 mm)	135 mm	stainless steel (matt) glass - lacomat
porthole 2 (Ø 320 mm, thickness: 18, 40 mm)	215 mm	
porthole 3 (Ø 350 mm, thickness: 18, 40 mm)	235 mm	
porthole 4 (Ø 400 mm, thickness: 18, 40 mm)	280 mm	

size	S ₀	colour
porthole 2 (Ø 300 mm, thickness: 35-45 mm)	225 mm	stainless steel
porthole 3 (Ø 350 mm, thickness: 35-45 mm)	265 mm	(matt) glass-lacomat
porthole 4 (Ø 400 mm, thickness: 35-45 mm)	295 mm	

size	S ₀	colour
porthole 2 (Ø 300 mm, thickness: 35-45 mm)	225 mm	stainless steel
porthole 3 (Ø 350 mm, thickness: 35-45 mm)	265 mm	(matt) glass-lacomat
porthole 4 (Ø 400 mm, thickness: 35-45 mm)	295 mm	

S₀ - dimension on the internal side of the porthole

DOOR MODELS	PORTHOLE ONLY IN FLUSH VERSIONS	NOTES
DECO, HAPTIC	BMD, BMJ, BMN	
DECO LUX	BMD, BMJ, BMN	
ETIUDA B0 pattern		
ETIUDA LUX B0 pattern	BMD, BMJ, BMN	
IMPULS	(BMD, BMJ, BMN) ¹⁾	only in version 01
INTERSOLID IP ²⁾	BMD ¹⁾	1) porthole only with a width of: "70", "80", "90" 2) except patterns 10, 11
INTERSOLID	BMD ¹⁾	1) porthole only with a width of: "70", "80", "90"
MODERN, MODERN DUO	BMD ¹⁾	1) porthole only with a width of: "70", "80", "90"
CAMBIO, CAMBIO DUO	BMD, BMJ, BMN	
INTER-AMBER	BMD, BMJ, BMN	
SIMPLE, SIMPLE DUO	BMD, BMJ, BMN	

Matt, safe glass - in standard (except BMD)
Transparent glass - extra charge + 13 (except BMJ)
chipboard must be ordered if a porthole is to be applied

CROWNS

FOR DOOR FRAME: DIN SYSTEM "60", DIN SYSTEM "80", POL-SKONE SYSTEM, DIN SYSTEM DUO, SYSTEM DUO

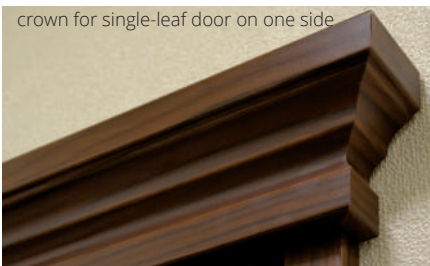

Crown for single-leaf door "60"- "90" on one side (1 piece)

Surface ECO TOP

Surfaces HIGH TOP, LAMISTONE CPL, SILKSTONE, UNI MAT PLUS

Painted*

Veneers GROUP A, GROUP B, GROUP C

EXTRA CHARGES		
	for the double-leaf door	+50%
	crown "100", "110"	+20%

*environment-friendly acrylic paints, RAL and NCS colours (except metallic ones) - available at an extra charge according to the colour groups (p. 264)

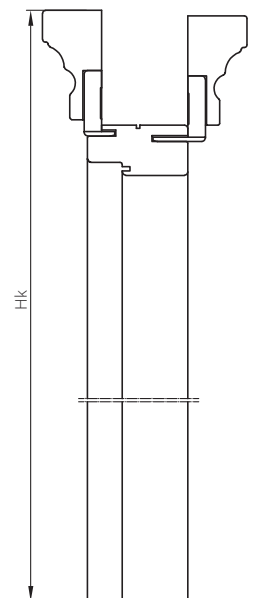
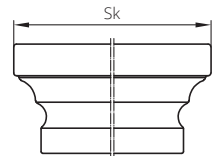

Sk - width on the external side of the crown
Hk - height on the external side of the crown

CROWN DIMENSIONS	for DIN door frame - Polish standard		for casing of in-wall door - Polish standard		for ZN, ZT DIN SYSTEM ZN SYSTEM DUO door frame (except DIN SYSTEM DUO) - Polish standard		for ZT POL-SKONE SYSTEM door frame - Polish standard		for ZT DIN SYSTEM DUO door frame - Polish standard		for ZY door frame - Polish standard		for adjustable wooden DUO (D) door frame - Polish standard		for DIN DUO (ZD) door frame - Polish standard		for ZZ (architrave 60 mm) door frame - Polish standard		
	architraves, thickness: 60 mm	architraves, thickness: 80 mm	architraves, thickness: 60 mm	architraves, thickness: 80 mm	architraves, thickness: 60 mm	architraves, thickness: 80 mm	architraves, thickness: 60 mm	architraves, thickness: 60 mm	hinge side range D1-D16	adjustment side range D13-D16	adjustment side range D1-D12	hinge side range ZZ1-ZZ17	adjustment side range ZZ4-ZZ11	adjustment side range ZZ1-ZZ3					
for single-leaf door	type				total width of door frame with crown Sk [mm]														
	"60"	823	863	802	842	823	863	874	869	913	913	903	869	875	865				
	"70"	923	963	902	942	923	963	974	969	1013	1013	1003	969	975	965				
	"80"	1023	1063	1002	1042	1023	1063	1074	1069	1113	1113	1103	1069	1075	1065				
	"90"	1123	1163	1102	1142	1123	1163	1174	1169	1213	1213	1203	1169	1175	1165				
	"90 plus"	1133	1173	-	-	-	-	-	-	-	-	1238	1228	1194	1185	1175			
"100"	1223	1263	1202	1242	1223	1263	1274	1269	1313	1313	1303	1269	1275	1265					
"110"	-	-	-	-	1323	1363	1374	1369	-	1413	1403	1369	1375	1365					
for double-leaf door	"60"+"60"	1457	1497	1393	1433	1456	1496	1508	1484	1540	1528	1518	1484	1510	1500				
	"70"+"60"	1557	1597	-	-	-	-	1608	1584	1640	1628	1618	1584	1610	1600				
	"70"+"70"	1657	1697	1593	1633	1656	1696	1708	1684	1740	1728	1718	1684	1710	1700				
	"80"+"60"	1657	1697	-	-	-	-	1708	1684	1740	1728	1718	1684	1710	1700				
	"80"+"70"	1757	1797	-	-	-	-	1808	1784	1840	1828	1818	1784	1810	1800				
	"90"+"60"	1757	1797	-	-	-	-	1808	1784	1840	1828	1818	1784	1810	1800				
	"80"+"80"	1857	1897	1793	1833	1856	1896	1908	1884	1940	1928	1918	1884	1910	1900				
	"90"+"70"	1857	1897	-	-	-	-	1908	1884	1940	2028	1918	1884	1910	1900				
	"90"+"80"	1957	1997	-	-	-	-	2008	1984	2040	2028	2018	1984	2010	2000				
	"90"+"90"	2057	2097	1993	2033	2056	2096	2108	2084	2140	2128	2118	2084	2110	2100				
"90"+"100"	2157	2197	-	-	-	-	2208	2184	2240	2228	2218	2184	2210	2200					
"100"+"100"	2257	2297	-	-	2256	2296	2308	2284	2340	2328	2318	2284	2310	2300					
total height of door frame with crown Hk [mm]																			
	2148	2148	2131	2131	2136	2136	2161	2156	2177	2177	2172	2156	2162	2157					

ACCESSORIES

HINGES FOR INTERIOR DOORS

rebated system



screw-in type B pivot hinge silver plating or brushed nickel

rebated system



screw-in pivot type D hinge silver plating or brushed nickel

rebated system



screw-in type C pivot hinge* silver plating or brushed nickel

rebated system



screw-in type K pivot hinge* silver plating or brushed nickel

rebated system



pivot type M hinge for the metal door frame, silver plated

rebated system



hinge with closing function (fixed wooden or one-sidedly adjustable door frame) silver plating

* hinges included in the door frame set When ordering the door leaf only, you must also order a hinge.

rebated system



three-part type T* silver hinge for DIN SYSTEM door frame

rebated system



three-part type T* black hinge for DIN SYSTEM door frame

rebated system



three-part type T* black hinge for metal door frame

rebated system



three-part type T* silver hinge for metal door frame

non-rebated system



adjustable hidden TE* silver hinge

non-rebated system



adjustable hidden TE* white hinge

non-rebated system



adjustable hidden TE* black hinge

non-rebated system



adjustable hidden DUO* nickel satin hinge

non-rebated system



adjustable hidden DUO* white hinge

non-rebated system



adjustable hidden DUO* black hinge (collection BLACK)

non-rebated system



adjustable hidden HARMONY* chrome satin hinge

non-rebated system



adjustable hidden HARMONY* white hinge

non-rebated system



adjustable hidden HARMONY* black hinge (collection BLACK)

LOCKS



rebated



non-rebated

lock colour change

NEW

HINGE CAPS, TYPE I (complete set of 2 pcs per one hinge)



colours: golden, chrome, chrome-matt patina, black

Type I caps are used for the type C and type K hinges. A complete set of caps per one hinge contains two identical caps.

HINGE CAPS, TYPE II (1 complete set per one hinge)

1 complete set - 2 pcs



colours: golden, chrome, chrome-matt, patin, brown, white, black

Type II caps are used for type B, type D hinges. A set of caps per one hinge consists of a short cap (the upper part) and a long cap (the lower part).

ACCESSORIES

DOOR CLOSER GEZE TS 2000 NV



closer
colours _____ price from _____
silver, white, brown _____
black _____

required reinforcement for door closer and reinforcement under the door frame architrave.
There are other door closer models - available subject to consultation with the Sales Department.

SURFACE-MOUNTED DOOR CLOSER TS PROFIL



door closer TS Profil
colours _____ price from _____
silver, white, brown, black _____
door closer TS PROFIL with a mounting board
colours _____ price from _____
silver, white, brown, black _____



drop seal
available separately (to be trimmed by the user)
fixed in the door
suitable only for door leaf with a min. thickness of 40 mm (lower rail and stile set).

HOOK LOCK for sliding doors



option: WK lock
chrome, chrome matt, golden, golden matt, patina
black



option: WC lock
chrome, chrome matt, golden, golden matt, patina
black

PULL HANDLES for sliding doors



U1 golden U2 golden matt U3 chrome U4 chrome matt U5 patina U6 black

golden, golden matt, chrome, chrome matt, patina, black

ENTERO handle



nickel satin

ENTERO II handle



stainless steel

ENTERO nickel satin for screws
ENTERO nickel satin for screw + WC hook lock
ENTERO II stainless steel + WC lock
ENTERO II stainless steel

MAYA handle

nickel satin + key lock
nickel satin
nickel satin + hook lock for cylinder
nickel satin + WC lock



nickel satin

PULL HANDLES for folding doors (included in the door leaf price as a standard)
made of plastic



01 white 02 beige 03 brown 04 grey

pull handle

2

ALUMINIUM DECORS (TIARA, SONATA)



chrome matt (standard)



golden gloss (option)



black (option)



chrome gloss (option)

HANDLES FOR INTERIOR DOORS

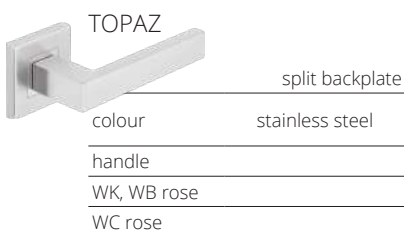
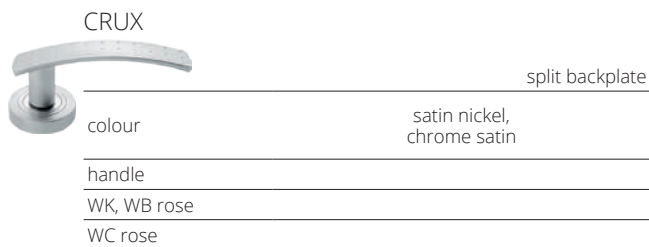
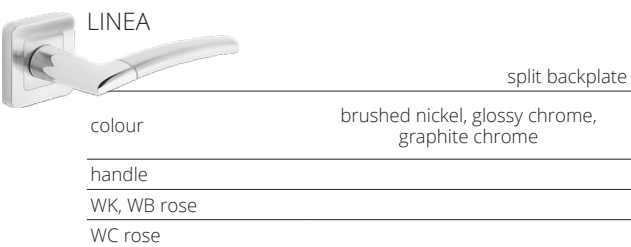
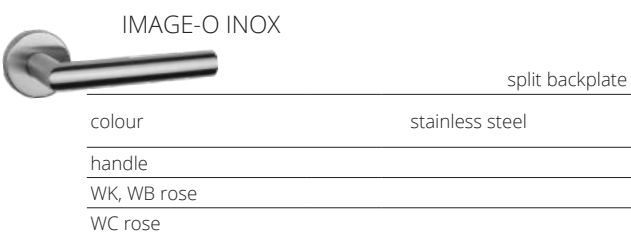
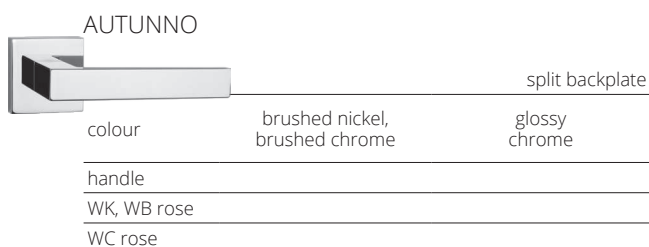
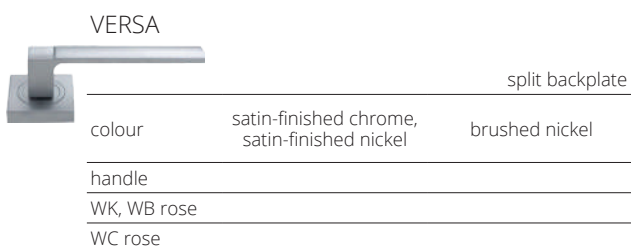
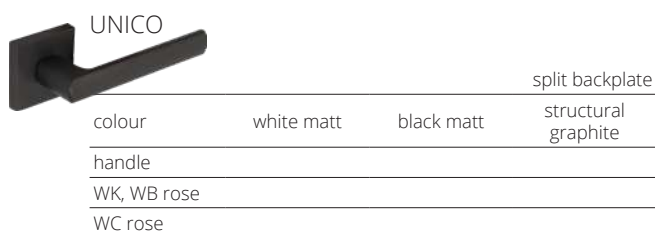
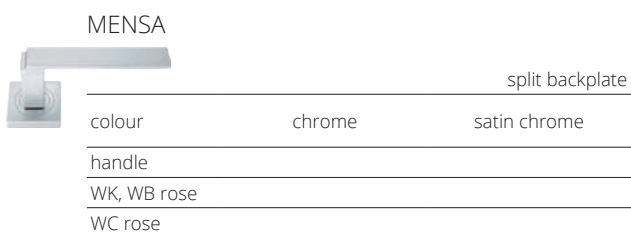
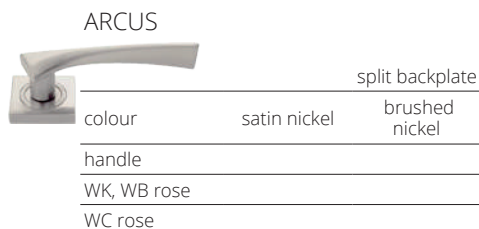

SEMPRE



	split backplate
colour	nickel
handle	
WK, WB rose	
WC rose	

ARABIS



	split backplate
colour	black
handle	
WK, WB rose	
WC rose	

IBIZA



	split backplate
colour	black
handle	
WK, WB rose	
WC rose	

ESTATE



	split backplate	
colour	brushed chrome, brushed nickel	glossy chrome
handle		
WK rose		
WC rose		

VERANO



	split backplate	
colour	brushed nickel, brushed chrome, black	glossy chrome
handle		
WK, WB rose		
WC rose		

TWIST



	split backplate
colour	stainless steel
handle	
WK, WB rose	
WC rose	

PRIMAVERA



	split backplate
colour	brushed chrome no insert, black without insert
handle	
WK rose	
WC rose	

INVERNO



	split backplate
colour	brushed nickel, brushed chrome, black
handle	
WK, WB rose	
WC rose	

Insert-compatible handle
- the insert in the colour of the door is available

APRILE



	split backplate
colour	glossy chrome, brushed chrome, brushed nickel
handle	
WK, WB rose	
WC rose	

LATON



	split backplate
colour	stainless steel
handle	
WK, WB rose	
WC rose	

HALLEY



	split backplate
colour	brushed chrome / nickel, antique brass
handle	
WK, WB rose	
WC rose	

NIQUEL



	split backplate
colour	stainless steel
handle	
WK, WB rose	
WC rose	

HIGRO



	split backplate
colour	stainless steel
handle + WK rose	
handle + WB rose	
handle + WC rose	

EXIMUS



	split backplate	
colour	chrome/black, chrome/white	chrome satin black/ chrome satin white
handle		
WK, WB rose		
WC rose		

Handle + WC HIGRO rose are only intended for the HIGRO door.

BERGENIA

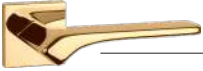

			split backplate
colour	black matt, chrome polished, chrome satin	golden polished golden matt	
handle			
WK, WB rose			
WC rose			

LUPINA



			split backplate
colour	black matt, chrome polished, chrome satin		
handle			
WK, WB rose			
WC rose			

ARNICA



			split backplate
colour	black matt, chrome polished, satin chrome		
handle			
WK, WB rose			
WC rose			

PATINA



			split backplate
colour	stainless steel		
handle			
WK, WB rose			
WC rose			

SATEN



			split backplate
colour	stainless steel		
handle			
WK, WB rose			
WC rose			

ANMI



			split backplate
colour	golden matt, golden gloss		
handle			
WK, WB rose			
WC rose			

GALE (left-hand, right-hand)



			longitudinal backplate, spacing: 72 mm
colour	brushed chrome / nickel, antique brass		
handle + WK rose			
handle + WB rose			
handle + WC rose			

dedicated to the door in the rebated system

CYLINDERS FOR INTERIOR DOOR

	price per 1 piece
30/35 LOB	
30/30 LOB	
30/40 LOB	
35/30 LOB	
26/26 WILKA	

WK – key-operated, WB – cylinder type, WC – bathroom privacy lock type

CYLINDERS FOR INTERIOR DOORS

Item	Cylinder size	Manufacturer	Interior door							
			rebated single-leaf door, Type A, Type B	rebated double-leaf door	non-rebated single-leaf door, Type A, Type B	non-rebated with electric strike	non-rebated double-leaf door	non-rebated double-leaf door Type A, Type B, HARMONY INVEST	Harmony, REVES	Lumen
1	30x35	LOB	x	x			x			
2	30x30	LOB			x					x
3	30x40	LOB						x		
4	35x30	LOB				x			x	
5	26x26	Wilka								x

CYLINDERS FOR INTERIOR ENTRANCE DOOR

30Gx35, 30x35G, 40x30G		35Gx45		35Gx40, 35x40G		40x40G		CERBER PLUS	
class 6 (C class) cylinder		class 6 (C class) cylinder		class 6 (C class) cylinder		class 6 (C class) cylinder		class B (brass, nickel) cylinder	
silver	black	silver	black	silver	black	silver	black	1 pcs	1 pcs (with knob)

cylinder with automatic recoding function 2+3



cylinder with automatic recoding function 2+3

ADDITIONAL INFORMATION



Authorised installation teams

Here you will find the addresses of authorised installation teams.



Installation Instructions

See videos presenting installation instructions.

WAYS OF CONNECTING ARCHITRAVES

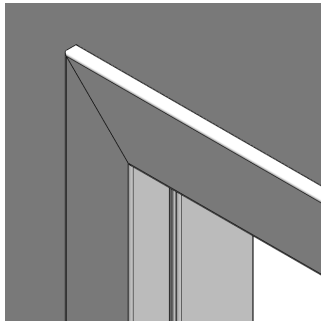

VERSION A

architraves interconnected at an angle of 45°
architraves 60 mm

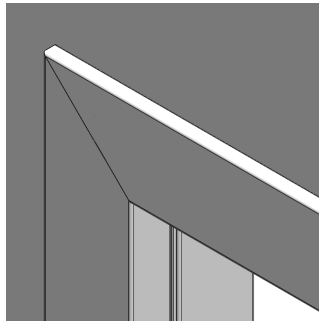

VERSION B

architraves interconnected at an angle of 45°
architraves 80 mm

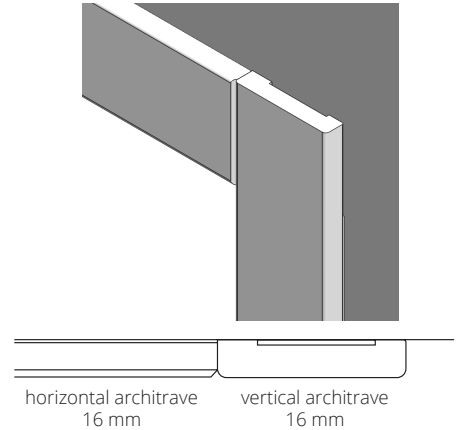

VERSION C 90°

cutting of architraves to 90°, 80 mm architrave (DIN version B, DIN DUO door frame only)

Glass pane in the door

See which side of the glass pane the matt side of the glass pane is

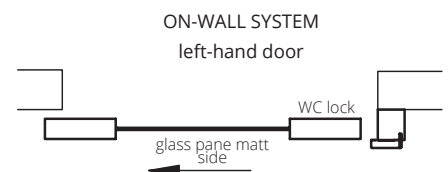
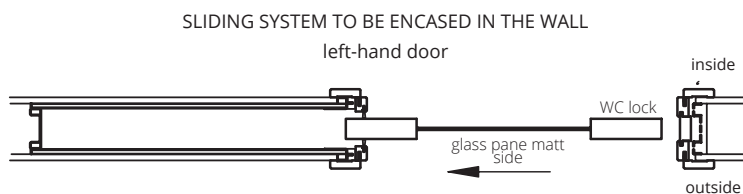
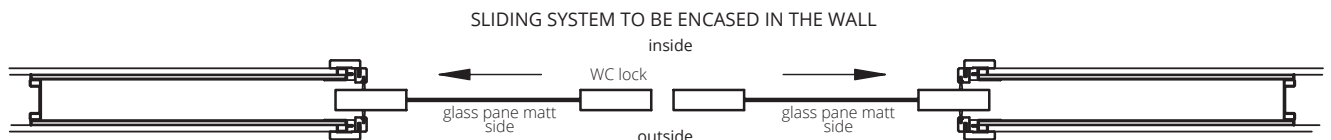
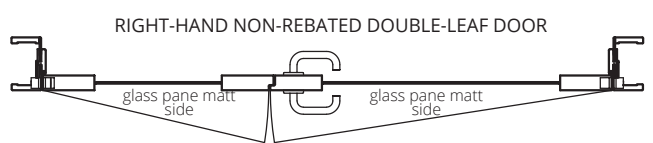
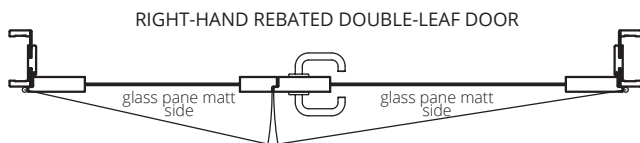
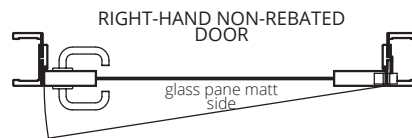
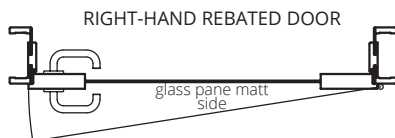

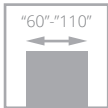

INTERIOR DOORS FOR ROOMS WITH THE RECUPERATION SYSTEM



recuperation trim

The following models include doors with a recuperation trim: CAMBIO, SIMPLE, TIARA, INTER-AMBER, IMPULS, SONATA, INVERNO, NOSTRE, DECO, DECO LUX, HARMONY, SUBLIME, VILANO, VERTIGO, FIORD, MODERN, MODENA, HAPTIC, SUBITO.
recuperation shortening for ARCO, SEDO, MODO, VERI, EGRO, FIORI, FORTIMO, MONA, SEMPRE, SEMPRE LUX, FORTIMO LUX doors (standard heights only) **+10%**
The door leaves are 15 mm shorter than the standard height, i.e. 2005 mm (rebated system) and 2025 mm (non-rebated system and outward-opening HARMONY), 2035 mm (inward-opening HARMONY), the door frame remains of the standard height.

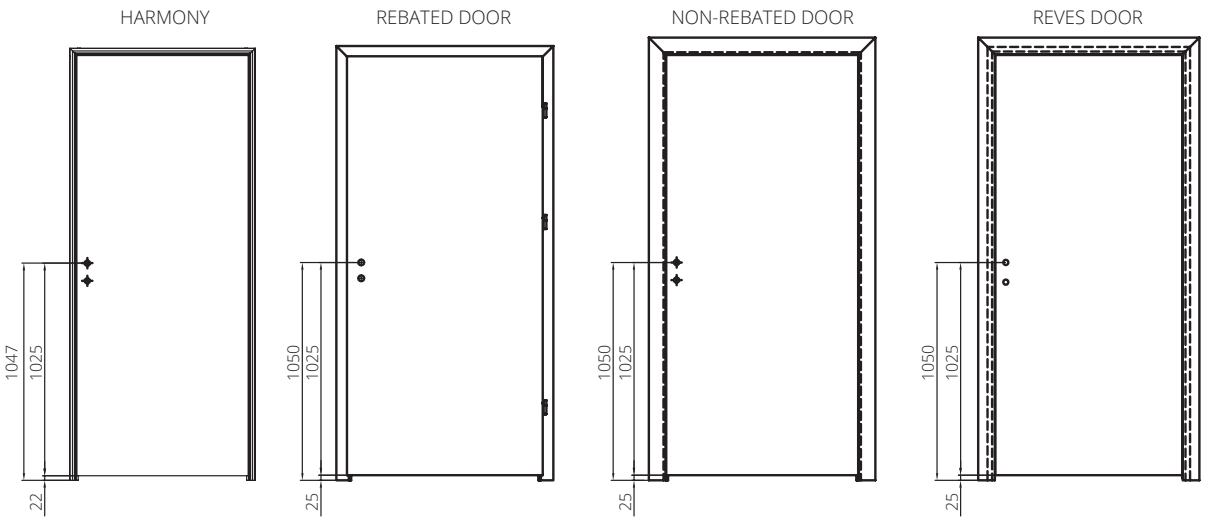

The door compatible with a recuperation system is available at a standard door price. In the www.drzwionline.pl configurator, the RECUPERATION TRIM option can be selected only when the standard height door leaf and door frame are selected as a complete set.



recuperation trim in CAMBIO door, 00 pattern, DIN SYSTEM adjustable frame

IMPORTANT USER INFORMATION ON 90 PLUS WIDTHS

FR EI30, EI30 PLUS EI60 PLUS

wooden door frame
FR EI30, EI30 PLUS

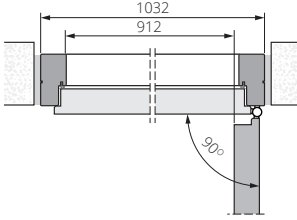

fixed metal door frame
EI30 PLUS

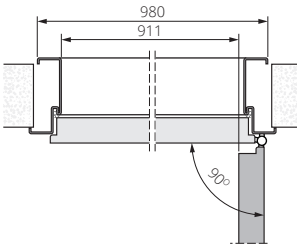

wooden door frame
EI60 PLUS

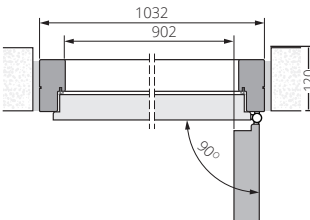

fixed metal door frame
EI60 PLUS

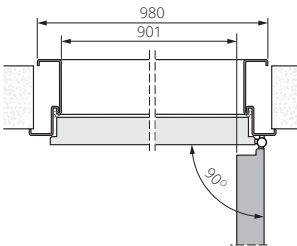

EI30 PLUS, EI60 PLUS

wooden door frame
non-rebated EI30 PLUS

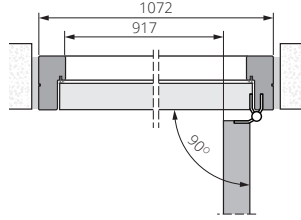

metal fixed door frame
non-rebated EI30 PLUS

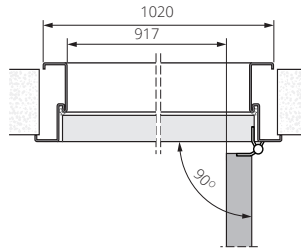

wooden non-rebated
door frame EI30 PLUS

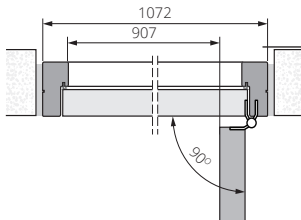

metal fixed non-rebated
door frame EI60 PLUS

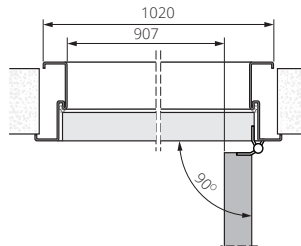

B-30, C-30, SR 37 dB, RC3, FR EI30, SR 42 dB

wooden door frame
B-30, C-30

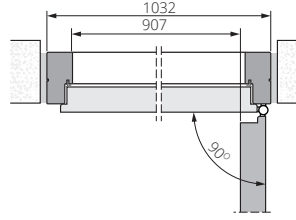

metal door frame
RC3, RC4

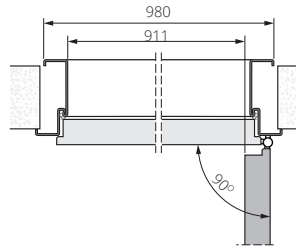

wooden door frame
RC3

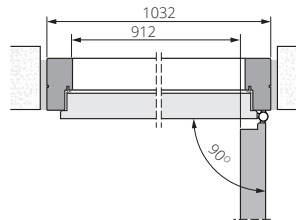

wooden door frame
FR EI30, SR 42 dB

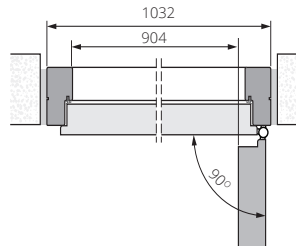

CERBER PLUS, DECO INVEST

wooden door frame
CERBER PLUS

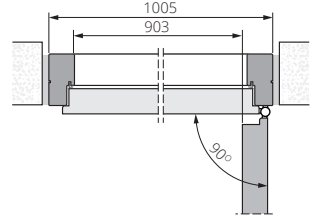

metal door frame
DECO INVEST

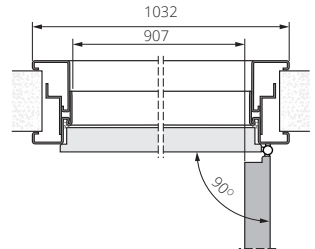

metal door frame
CERBER PLUS

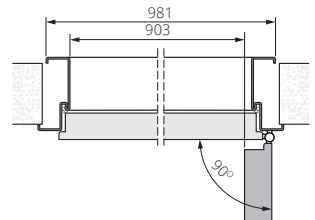

SOUNDPROOF, TYPE A, TYPE B, INTERIOR

wooden door frame
TYPE A, B, interior
with class 3 mechanical strength,
interior

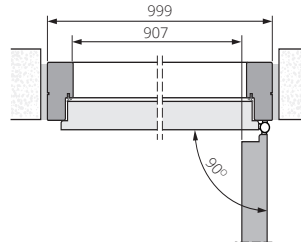

metal door frame
TYPE A, B, interior

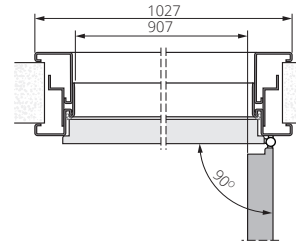

door frame ZP
TYPE A, B, interior
with class 3 mechanical strength,
interior

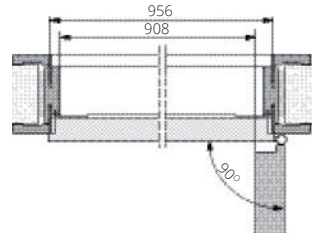

DUO INTERIOR DOOR

door frame ZD

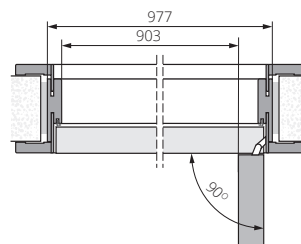

metal door frame

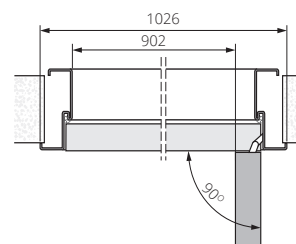

wooden DUO door frame
TYPE A, B Duo, interior non-rebated

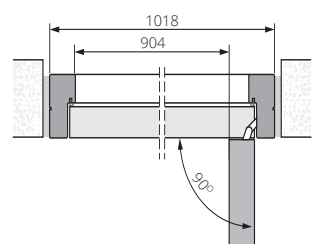

TECHNICAL DIMENSIONS

FR EI30, EI 30 PLUS, EI 60 PLUS, B-30, C-30, RC3, SR 37 dB, SR 42 dB, CERBER PLUS, GAMMA WOODEN DOOR FRAME

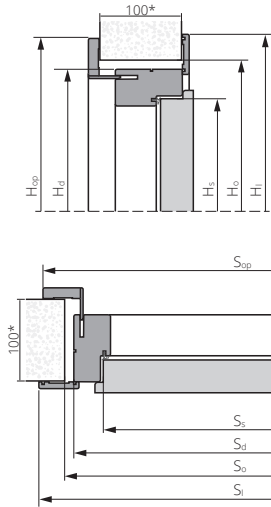

FR EI30 (TWO-SIDED ADJUSTMENT)

SOUND-PROOF TYPE A, B WOODEN DOOR FRAME

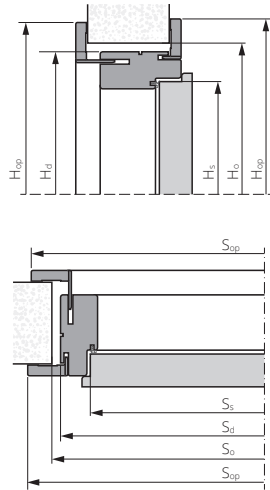

SOUND-PROOF TYPE A, B FIXED WOODEN DOOR FRAME

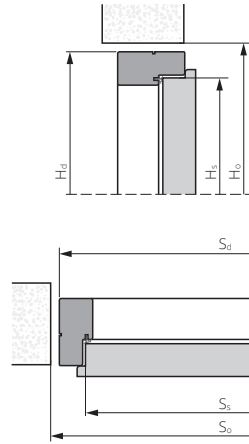

EI30 PLUS, EI60 PLUS WOODEN DOOR FRAME

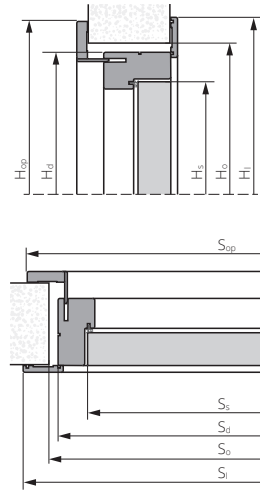

SOUND-PROOF TYPE A, B WOODEN NON-REBATED DOOR FRAME

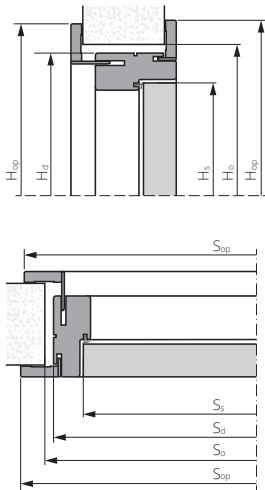

SOUND-PROOF TYPE A, B DIN ZP ADJUSTABLE DOOR FRAME

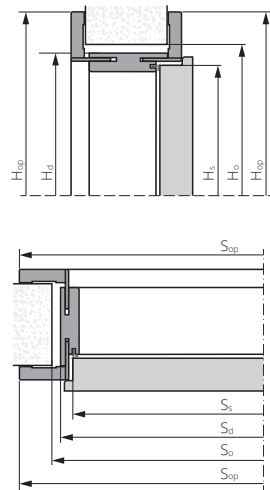

EI30 PLUS, EI60 PLUS, RC3, RC4, GAMMA, DECO INVEST, CERBER PLUS FIXED METAL DOOR FRAME

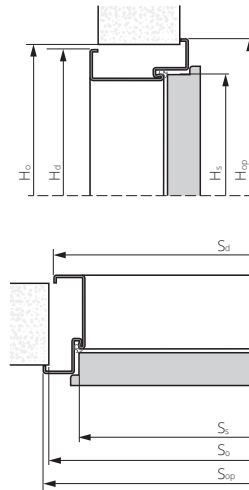

EI30 PLUS, EI60 PLUS ADJUSTABLE METAL DOOR FRAME

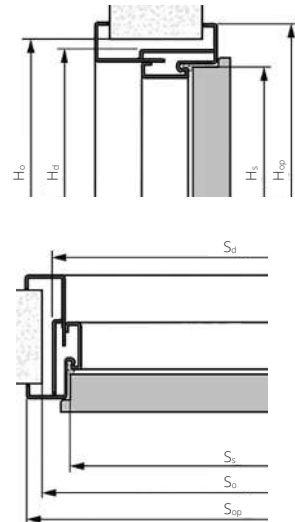

SOUNDPROOF TYPE A, B, DECO INVEST, GAMMA ADJUSTABLE METAL DOOR FRAME

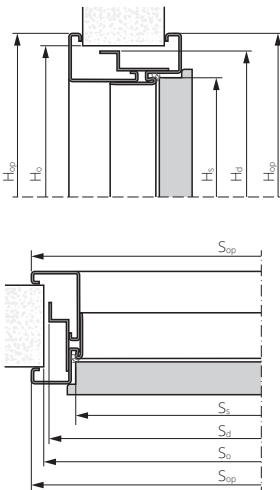

EI30 PLUS, EI60 PLUS, HIGRO FIXED METAL DOOR FRAME

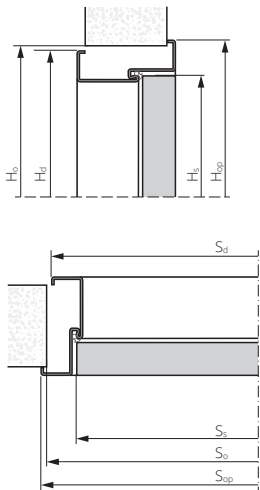

EI30 PLUS, EI60 PLUS ADJUSTABLE METAL DOOR FRAME

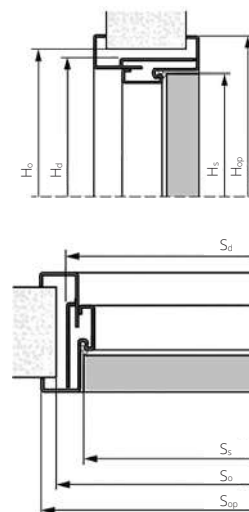

SWING DOOR FIXED WOODEN DOOR FRAME

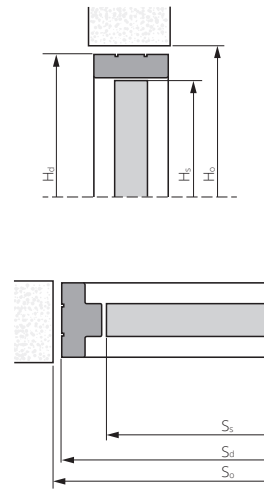

* in case of EI60 PLUS door, width of 120 mm

TECHNICAL DIMENSIONS

Door type	Door frame type	Size	Ss	Hs	Sd	Hd	Sop Sc	Hop Hc	Sop with panel	Hop with panel	Sl	HI	So	Ho		
FIRE DOOR	EI30 PLUS EI60 PLUS rebated version	wooden	"60"	624	2026	712	2075	806	2121	816	2126	823	2130	740	2090	
			"70"	724		812		906		916		923		840		
			"80"	824		912		1006		1016		1023		940		
			"90"	924		1012		1106		1116		1123		1040		
			"90" plus	944		1032		1126		1136		1143		1060		
			"100"	1024		1112		1206		1216		1223		1140		
		"90"+"90"	924 936	1952	2046	2056	2063	1980								
		"100"+"100"	1024 1036	2152	2246	2256	2263	2180								
		adjustable metal	"60"	624	661	2026	724	2038	-	2081	-	-	-	-	665*	2055
			"70"	724	761		824		-		-		765*			
			"80"	824	861		924		-		-		865*			
			"90"	924	961		1024		-		-		965*			
	"90" plus		944	981	1044		-		-		985*					
	"100"		1024	1061	1124		-		-		1065*					
	fixed metal	"60"	624	660	2026	704	2049	-	2071	-	-	-	-	680*	2060	
		"70"	724	760		804		-		-		780*				
		"80"	824	860		904		-		-		880*				
		"90"	924	960		1004		-		-		980*				
		"90" plus	944	980		1024		-		-		1000*				
		"100"	1024	1060		1104		-		-		1080*				
	FR EI30	wooden	"60"	624	2026	712	2075	806	2121	816	2126	823	2130	740	2090	
			"70"	724		812		906		916		923		840		
			"80"	824		912		1006		1016		1023		940		
			"90"	924		1012		1106		1116		1123		1040		
			"90" plus	944		1032		1126		1136		1143		1060		
			"100"	1024		1112		1206		1216		1223		1140		
		"90"+"90"	924 936	1952	2046	2056	2063	1980								
		"100"+"100"	1024 1036	2152	2246	2256	2263	2180								
		FR EI30 double-sided adjustment	wooden	"60"	624	2026	712	2075	806	2121	816	2126	815	2125	740	2090
				"70"	724		812		906		916		915		840	
"80"				824	912		1006		1016		1015		940			
"90"				924	1012		1106		1116		1115		1040			
"90" plus	944			1032	1126		1136		1135		1060					
"100"	1024			1112	1206		1216		1215		1140					
EI30 Plus EI60 Plus non-rebated version	wooden	"60"	625	2026	712	2075	806	2121	816	2126	823	2130	740	2090		
		"70"	725		812		906		916		923		840			
		"80"	825		912		1006		1016		1023		940			
		"90"	925		1012		1106		1116		1123		1040			
		"90" plus	985		1072		1166		1176		1183		1100			
		"100"	1025		1112		1206		1216		1223		1140			
	"90"+"90"	925 925	1930	2024	2034	2041	1960									
	"100"+"100"	1025 1025	2130	2224	2234	2241	2160									
	adjustable metal	"60"	625	660	2026	724	2045	-	2081	-	-	-	-	665*	2055	
		"70"	725	760		824		-		-		765*				
		"80"	825	860		924		-		-		865*				
		"90"	925	960		1024		-		-		965*				
"90" plus		985	1020	1084		-		-		1025*						
"100"		1025	1060	1124		-		-		1065*						
fixed metal	"60"	625	660	2026	724	2049	-	2081	-	-	-	-	680*	2060		
	"70"	725	760		824		-		-		780*					
	"80"	825	860		924		-		-		880*					
	"90"	925	960		1024		-		-		980*					
	"90" plus	985	1020		1084		-		-		1040*					
	"100"	1025	1060		1124		-		-		1080*					
FR EI30 SR	wooden	"60"	625	2025	712	2075	806	2121	816	2126	823	2130	740	2090		
		"70"	725		812		906		916		923		840			
		"80"	825		912		1006		1016		1023		940			
		"90"	925		1012		1106		1116		1123		1040			
		"90" plus	985		1072		1166		1176		1183		1100			
		"100"	1025		1112		1206		1216		1223		1140			
	B-30 C-30 RC3	wooden	880	792	2022	880	2075**	974	2121	984	2126	991	2130	910	2090	
			980	892		980		1074		1084		1091		1010		
			"90"	924		1012		1106		1116		1123		1040		
			"90" plus	944		1032		1126		1136		1143		1060		
			"100"	1024		1112		1206		1216		1223		1140		
			RC 3 INVEST	fixed metal		"80"		824		2022		860		2049		924
"90"	924	960	1024		-	-	985									
"90" plus	944	980	1044		-	-	1005									
RC4 RC4 EI30	fixed metal	"100"	1024	2022	1060	2044	1124	2066	-	-	-	-	1085	2054		
"80"		824	860		904		-		-		880*					
"90"		924	960		1004		-		-		980*					
CERBER PLUS	fixed wooden	"90" plus	944	2020	1005	2067	1098	2114	1108	2119	1101	2120	1035	2080		
		"100"	1018		1095		1188		1198		1201		1125			
		"80"	818		895		988		998		1001		925			
CERBER PLUS RC2	metal	"90"	918	2020	995	2055	1088	2078	1098	-	-	-	1025	2060		
		"90" plus	928		1005		1098		1108		1111		1035			
		"100"	1018		1095		1188		1198		1201		1125			
RC 3 INVEST 37dB	metal	"80"	824	2026	874	2057	920	2080	-	-	-	-	900	2065		
		"90"	924		974		1020		-		-		1000			
		"90" plus	944		994		1040		-		-		1020			
		"100"	1024		1074		1120		-				1100			

TECHNICAL DIMENSIONS

Door type	Door frame type	Size	Ss	Hs	Sd	Hd	Sop Sc	Hop Hc	Sop with panel	Hop with panel	SI	HI	So	Ho		
ACOUSTIC DOORS	SR 37 dB	wooden	"80"	824	2022	912	2075	1006	1016	2126	1023	2130	940	2090		
			"90"	924		1012		1106	1116		1123		1040			
			"100"	1024		1112		1206	1216		1223		1140			
	AKUSTIC 42 dB	fixed metal	"80"	824	2026	876	2057	922	-	2080	-	-	-	895	2070	
			"90"	924		976		1022	-		-	995				
			"90" plus	944		996		1042	-		-	1015				
		adjustable metal	"100"	1024	2026	1076	2064	1122	-	2080	-	-	-	1095	2070	
			"80"	824		891		922	-		-	900				
			"90"	924		991		1022	-		-	1000				
			"90" plus	944		1011		1042	-		-	1010				
			"100"	1024		1091		1122	-		-	1100				
			"100" plus	1024		1091		1122	-		-	1100				
	TYPE A TYPE B - rebated version	adjustable metal	"80"	818	2020	884	2062	917	-	2078	-	-	-	889	2065	
			"90"	918		984		1017	-		-	989				
			"90" plus	928		994		1027	-		-	999				
			"100"	1018		1084		1117	-		-	1089				
		adjustable wooden	"80"	818	2020	895	2067	988	998	2113	998	2118	998	2118	915	2080
			"90"	918		995		1088	1098		1098		1015			
			"90" plus	928		1005		1098	1108		1108		1025			
			"100"	1018		1095		1188	1198		1198		1115			
		fixed wooden	"80"	818	2020	889	2064	-	-	-	-	-	-	-	910	2075
			"90"	918		989		-	-		-		1010			
			"90" plus	928		999		-	-		-		1020			
			"100"	1018		1089		-	-		-		1110			
		adjustable DIN	"80"	818	2020	846	2043	946	-	2093	-	-	-	-	875	2055
			"90"	918		946		1046	-		-		975			
			"90" plus	928		956		1056	-		-		985			
			"100"	1018		1046		1146	-		-		1075			
			"80"	825		893		1026	-		-		915			
			"90"	925		993		1126	-		-		1015			
	TYPE A Duo TYPE B Duo - non-rebated version	adjustable wooden	"90" plus	950	2040	1018	2083	1151	1136	2149	1161	2154	1136	2154	1040	2095
			"100"	1025		1093		1226	1236		1236		1115			
			"90"+"90"	925 925		1908		2041	2051		2051		1930			
			"100"+"100"	1025 1025		2108		2241	2251		2251		2130			
		fixed wooden	"80"	825	2040	893	2083	-	-	-	-	-	-	-	915	2095
			"90"	925		993		-	-		-		1015			
			"90" plus	950		1018		-	-		-		1040			
			"100"	1025		1093		-	-		-		1115			
			"90"+"90"	925 925		1908		-	-		-		1930			
			"100"+"100"	1025 1025		2108		-	-		-		2130			
"80"			825	872		902		-	-		885					
"90"			925	972		1002		-	-		985					
"90" plus	950	997	1027	-	-	1010										
"100"	1025	1072	1102	-	-	1085										
GAMMA	wooden	"80"	818	2020	895	2067	988	998	2114	1098	2119	1001	2120	915	2080	
		"90"	918		995		1088	1098		1101		1015				
		"100"	1018		1095		1188	1198		1201		1115				
		"110"	1118		1195		1288	1298		1301		1215				
		"90"+"90"	918 931		1930		2023	2033		2036		1950				
		"100"+"100"	1018 1031		2130		2223	2233		2236		2150				
		"110"+"110"	1118 1131		2330		2423	2433		2436		2350				
	adjustable metal	"80"	818	2020	884	2062	917	-	2078	-	-	-	-	890	2065	
		"90"	918		984		1017	-		-		990				
		"100"	1018		1084		1117	-		-		1090				
		"110"	1118		1184		1217	-		-		1190				
		"90"+"90"	918 931		1925		1951	-		-		1925				
		"100"+"100"	1018 1031		2125		2151	-		-		2125				
		"110"+"110"	1118 1131		2225		2351	-		-		2325				
	fixed metal	"80"	818	2020	871	2055	897	-	2068	-	-	-	-	881	2060	
		"90"	918		971		997	-		-		981				
		"100"	1018		1071		1097	-		-		1081				
		"110"	1118		1171		1197	-		-		1181				
		"90"+"90"	918 931		1905		1931	-		-		1915				
		"100"+"100"	1018 1031		2105		2131	-		-		2115				
		"110"+"110"	1118 1131		2305		2331	-		-		2315				
	DECO INVEST	fixed metal	"70"	721	2020	774	2055	800	-	2068	-	-	-	-	785	2060
			"80"	821		874		900	-		-		885			
			"90"	921		974		1000	-		-		985			
"90" plus			931	984		1010		-	-		995					
"100"			1021	1074		1100		-	-		1085					
"110"			1121	1174		1200		-	-		1185					
"90"+"90"			921 934	1908		1934		-	-		1918					
"100"+"100"		1021 1034	2108	2134	-	-	2118									
adjustable metal		"80"	821	2020	888	2062	920	-	2078	-	-	-	-	892	2065	
		"90"	921		988		1020	-		-		992				
		"90" plus	931		998		1030	-		-		1002				
		"100"	1021		1088		1120	-		-		1092				
		"110"	1121		1188		1220	-		-		1192				
		"90"+"90"	921 934		1922		1954	-		-		1925				
	"100"+"100"	1021 1034	2122		2154		-	-		2125						
SWING DOOR	fixed wooden	"60"	644	2033	769	2076	-	-	-	-	-	-	-	795	2090	
		"70"	744		869		-	-		-		895				
		"80"	844		969		-	-		-		995				
		"90"	944		1069		-	-		-		1095				
		"60"+"60"	644 644		1418		-	-		-		1445				
		"70"+"70"	744 744		1618		-	-		-		1645				
		"80"+"80"	844 844		1818		-	-		-		1845				
		"90"+"90"	944 944		2018		-	-		-		2045				

** door for a height of 2000 mm and 1950 mm is available
 Ss - door leaf width
 Hs - door leaf height
 Sd - door width
 Hd - door height
 Sop - door width on the external side of architrave 60 mm
 Hop - door height on the external side of architrave 60 mm

* in-wall cavities for cover boxes are required
 Sop with panel - width on the external side of the architrave for ranges with widening panel
 Hop with panel - height on the external side of the architrave for ranges with widening panel
 SI - door width at architraves/strips 60 mm on the hinge side
 HI - door height at architraves/strips 60 mm on the hinge side
 So - suggested width of the installation opening
 Ho - suggested height of the installation opening

DIMENSIONS OF INTERIOR DOOR LEAVES

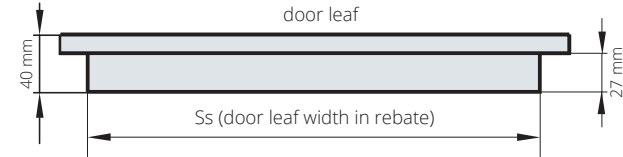

the POL-SKONE rebated door leaves fit all door frames which comply with the Polish industry standards

width (Ss)				height in rebate
618	718	818	928*	2020 (mm)



width (Ss)					height
625	725	825	925	950*	2040 (mm)

*width "90 plus"

Full range of dimensions of interior doors with door frames - p. 210-231

HANDLE HEIGHT

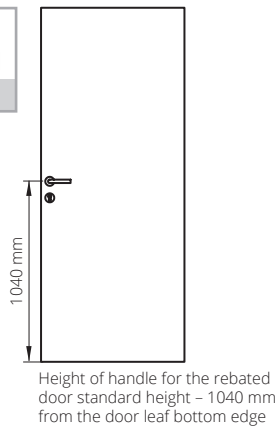

SYMMETRY ABOVE ALL
UNIFORM HEIGHT OF HANDLE IN REBATED AND NON-REBATED SYSTEM

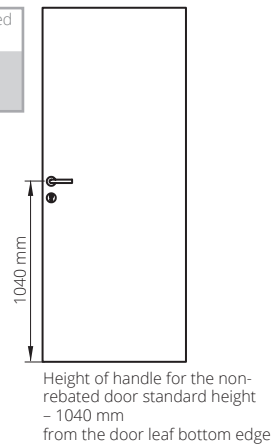

single-leaf rebated door - opening directions

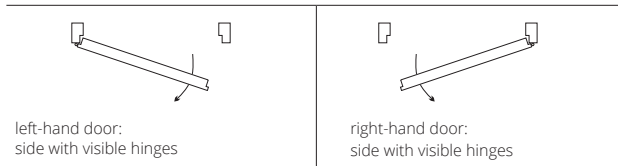

double-leaf rebated door - opening directions

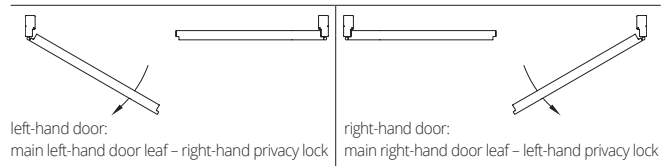

non-rebated DUO door - opening directions

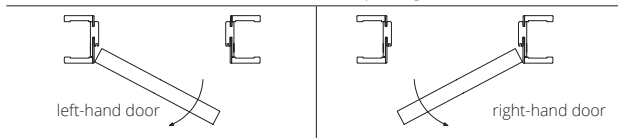

REVES door - opening directions

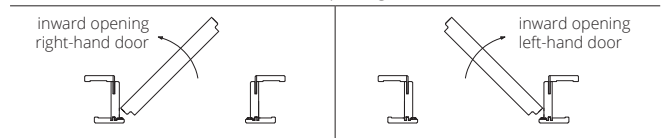

HARMONY door - opening directions

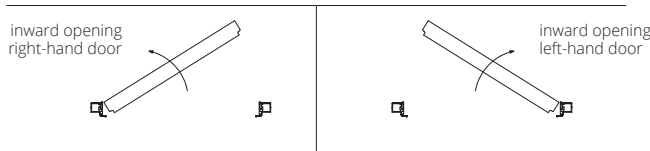

HARMONY door - opening directions

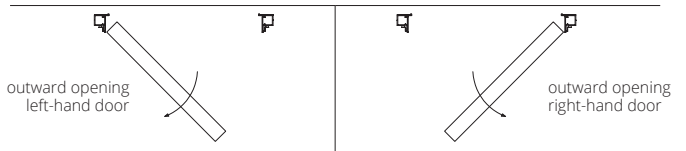

CLEARANCE BETWEEN LEAF AND FLOOR

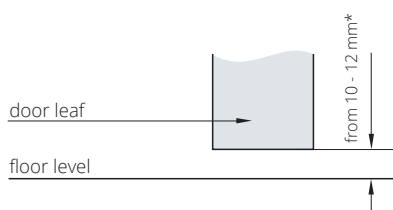

*the clearance for the HARMONY door leaves is 7 mm

version with the Swiss threshold (optional)

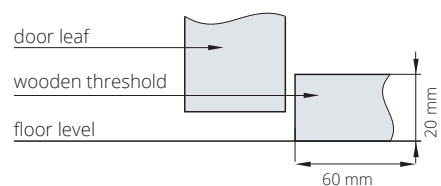

Dimensions of interior entrance doors and exterior doors are provided on pages dedicated to the particular door models.

COLOURS

ECO TOP

Surface finish as a perfect combination of price and quality for long-lasting domestic use. in households.

HIGH TOP

ECO TOP surface finish with additional real wood grain effect.

UNI MAT PLUS

reinforced surface with silky tactile experience and special fingerprint-proof coating

LAMISTONE CPL

Surface finish with protective coating for resistance to wear and chemicals. Recommended for public utility buildings and used in door carpentry intensive service conditions, e.g. in hotels and offices.

SILKSTONE

LAMISTONE CPL surface finish with additional unique real wood grain effect

SILKSTONE CPL 0.5 mm

Surface finish featuring the properties and resistance of LAMINATE CPL 0.5 with additional unique real wood grain effect. Recommended for public utility buildings and used in door carpentry intensive service conditions, e.g. in hotels and offices.

LAMINATED

Highly resistant surface finish recommended for public utility buildings and used in heavy conditions in which door systems are used, e.g. in hotels and offices. * Difference in colour shades of door leaves and door frames are permissible.

VENEERED

The VENEERED POL-SKONE doors are coated with environment-friendly UV varnish. It is certainly more resistant to scratches and light than standard varnishes even when laid in multiple layers. The actual colour shades and wood grain of veneers may vary since natural veneers have been used.

PAINTED

Environment-friendly acrylic paints, RAL and NCS colours* (except metallic ones) – available at an extra charge according to the colour specification table for particular models.

ECO TOP

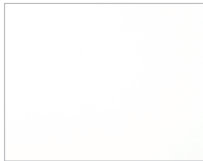

120 white

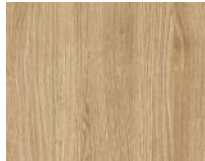

121 oak



132 walnut



141 Salinas oak



158 honey oak



160 sonoma oak



161 halif oak

HIGH TOP



148 coffee ash

UNI MAT PLUS



640 graphite



641 titano

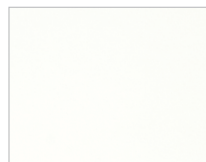

642 white



643 beige



644 black



645 lava



646 stone



647 indigo



648 moss



649 sage

* colours available subject to consultation with the Sales Department

The actual colours may vary from the colours printed in this catalogue. Differences in colour shades of door leaves, door frames and spacer frames are acceptable.

LAMISTONE CPL



231 halif oak



240 whitewashed elm V



241 sand elm V



242 grey elm V



243 delano oak

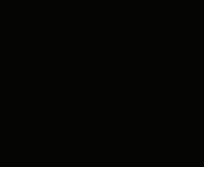

244 black



250 terra oak

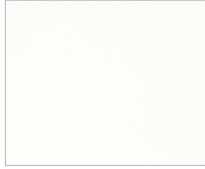

258 white



260 white oak



263 premium walnut



265 wenge

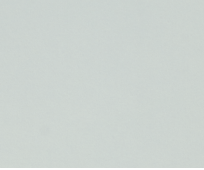

289 grey



531 anthracite



232 segato walnut

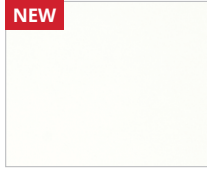

213 superwhite



233 Salinas oak

LAMISTONE CPL



210 filo



211 fibra



212 lino

new unique CPL 0.15 surface with a texture of linen fabric interwoven with metallic shine

SILKSTONE



230 gran oak



254 Royal anthracite H



255 Polish ash H



276 Polish oak

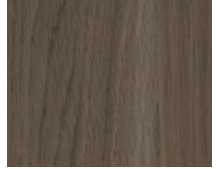

293 Royal anthracit

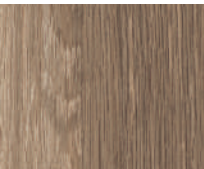

294 Royal ash

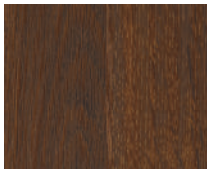

295 Royal merbau

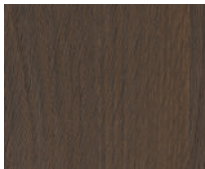

297 Royal nugat*



299 Royal ash H

SILKSTONE CPL 0.5 mm*



976 Polish oak

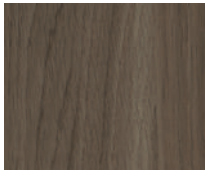

993 Royal anthracit



994 Royal ash

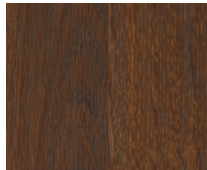

995 Royal merbau

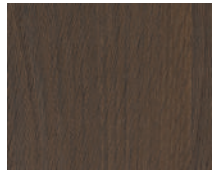







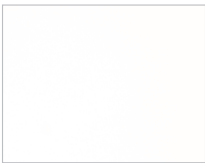

997 Royal nugat*

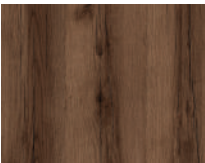

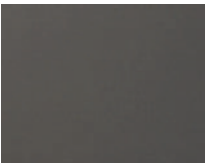
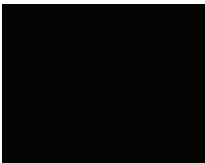



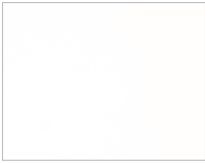

* colours available subject to consultation with the Sales Department

The actual colours may vary from the colours printed in this catalogue. Differences in colour shades of door leaves, door frames and spacer frames are acceptable.







LAMINATED CPL 0.2 mm

					
820 white	222 grey	225 terra oak	227 delano oak	229 oak	
					
280 halif oak	821 anthracite	844 black	849 industry 3**	863 premium walnut	228 segato walnut
					
NEW					
833 Salinas oak					

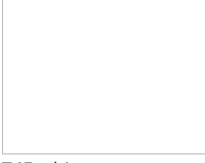
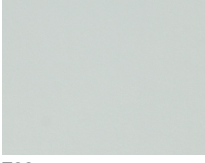

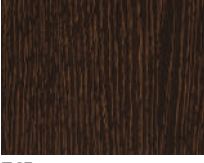





LAMINATED CPL 0.5 mm*

				
945 white structure	252 oak	922 grey structure	926 anthracite structure	965 wenge
				
963 premium walnut	946 black structure	961 halif oak	NEW	
			933 Salinas oak	

LAMINATED CPL 0.7 mm*

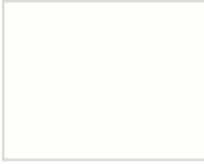
				
745 white structure	722 grey structure	779 oak	726 anthracite structure	765 wenge
				
763 premium walnut	746 black structure	761 halif oak	NEW	
			733 Salinas oak	

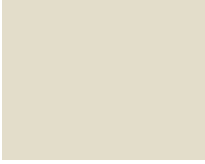
LAMINATED HPL*

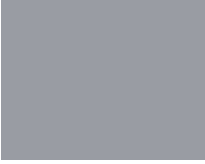
				
0010	0075	0077	0080	0085
				
0717	0730	0743	0747	0753

* colours available subject to consultation with the Sales Department
 ** colours are subject to availability
 The actual colours may vary from the colours printed in this catalogue. Differences in colour shades of door leaves, door frames and spacer frames are acceptable.

**VENEERED
GROUP A**



312 limba



334 European oak

**VENEERED
GROUP B**

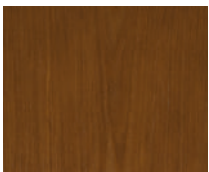

323 rustikal oak



340 ebony



351 marrone*



390 natural walnut

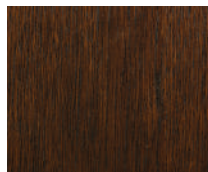

404 dark walnut

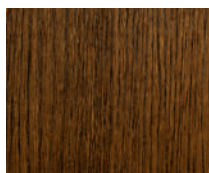

405 light walnut

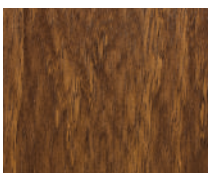

421 cappuccino

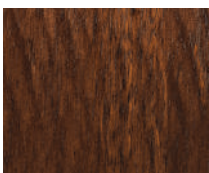

422 mokka



424 teak

**VENEERED
GROUP C**



370 whitewashed oak

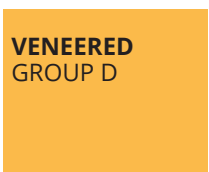

311 light walnut*



313 classic oak

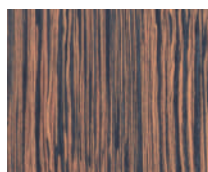

460 makassar

SILKWOOD



450 white matt



451 black matt

PAINTED

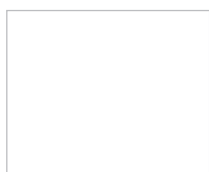

001 white (RAL 9003)



0M6 beige matt
(NCS S 2005 Y50R)

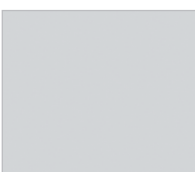

0M5 grey matt
(RAL 7047)



RAL and NCS colours**

BLACK



002 black (RAL 9005)



0M7 sage matt
(NCS S 4010-G50Y)

* colours available subject to consultation with the Sales Department
* NCS colours available subject to consultation with the Sales Department

The samples and colour charts available on the market are to be considered as purely illustrative. They may differ slightly from the final painting effect and cannot provide grounds for a complaint unless the colour/painting has been approved in advance in consultation with the manufacturer. In order to verify the actual colour, a sample painting must be ordered/prepared.

RAL SYSTEM classification of colours according to the colour intensity grade (except metal frames). RAL system colours for metal door frames - p. 223

GROUP I extra charge according to the extra charge table

6020 7002 7042 8000 9000 9002 9003 9011 9017

GROUP II extra charge according to the extra charge table

1000 1001 1002 1012 1014 1015 1020 4002 5001 5007 5008 5009 5010 5012 5015 5017 5019 5022 5024 6000 6001 6004 6007 6009 6012 6013 6014 6015 6021 6022 6026 6028 6029 6032 6034 7000 7001 7003 7004 7005 7006 7008 7009 7010 7011 7012 7013 7015 7022 7023 7024 7026 7030 7031 7032 7033 7034 7035 7036 7037 7038 7039 7040 7043 7044 7045 7046 7047 8001 8003 8007 8008 8011 8014 8015 8016 8017 8019 8022 8025 8027 8028 9001 9005 9010 9016 9018

GROUP III extra charge according to the extra charge table

1011 1027 3009 3012 3014 3015 5004 5014 5018 5021 6002 6006 6010 6017 6018 6025 6027 6033 8004 8012 9004

GROUP IV extra charge according to the extra charge table

1013 3007 4001 4003 4005 4008 4009 5000 5002 5003 5023 6003 6011 6019 6031 8024

GROUP V extra charge according to the extra charge table

1003 1004 1005 1006 1007 1016 1017 1018 1019 1021 1023 1024 1028 1032 1033 1034 1037 2000 2001 2002 2003 2004 2008 2009 2010 2011 2012 3000 3001 3002 3003 3004 3005 3011 3013 3016 3017 3018 3020 3022 3027 3028 3031 4004 4006 4007 4010 5005 5011 5013 5020 6005 6008 6016 6024 6037 7016 7021 8002 8023

HPL LAMINATES

HPL laminate, thickness: 1 mm, FH structure.

UNI laminate code	The approximate RAL/NCS equivalent suggested is not 100% compatible	Wooden door frame and edging; metal door frame	Metal door frame	extra charge	
				"60"- "100"	"110"- "120"
0010	RAL 1023	door frame painted, edging painted	RAL 1023, edging painted	individual pricing depending on width, height and quantity of doors	
0075	RAL 7037	door frame painted, edging painted	RAL 7037, edging painted		
0077	RAL 7024	door frame painted, edging painted or Lamistone 531 option, anthracite edging	RAL 7024, edging painted		
0080	RAL 9005	door frame painted, edging painted or Lamistone 244 option, black edging	RAL 9005, edging painted		
0085	RAL 9016	door frame painted, edging painted Lamistone 258 option, white edging	RAL 9003, edging painted		
0717	RAL 5015	door frame painted, edging painted	RAL 5015, edging painted		
0730	RAL 7035/RAL 7047	door frame painted, edging painted or Lamistone 289 option, grey edging	RAL 7035/RAL 7047, edging painted		
0743	RAL 7044	door frame painted, edging painted	RAL 7044, edging painted		
0747	RAL 7030	door frame painted, edging painted	RAL 7030, edging painted		
0753	RAL 7045	door frame painted, edging painted	RAL 7045, edging painted		

COLOUR UNI MAT PLUS	EQUIVALENT TO RAL/NCS S (SUGGESTED) NOT 100% COMPATIBLE
WHITE 642	RAL 9003
BEIGE 643	NCS S 2005 Y50R
GRAPHITE 640	RAL 7024
TITANO 641	RAL 7037
LAVA 645	7013 or 7006
STONE 646	RAL 1019
INDIGO 647	RAL 5011
MOSS 648	RAL 6012
SAGE 649	NCS S 4010 G50Y

AVAILABILITY OF EDGING IN THE RAL OR NCS PAINTED COLOURS to be priced individually
 applies to laminated doors (extra charge added to 1 piece)

HPL LAMINATES WITH ANTIBACTERIAL COATING

All HPL POLYREY SANITIZED laminates are subject to antimicrobial silver-ion core treatment to ensure their long-lasting antimicrobial properties which are very important in the health and catering industries and in public spaces. The doors in the unique coating are dedicated to **hospitals and medical facilities**.

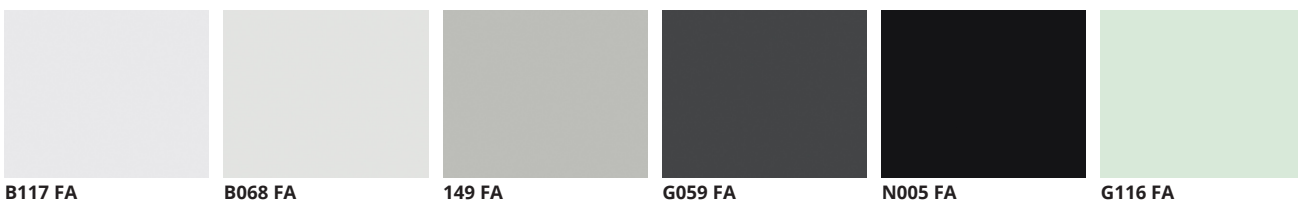

UNI laminate code	The approximate RAL/NCS equivalent suggested is not 100% compatible	Wooden door frame and edging; metal door frame	Metal door frame	extra charge to 1 door with the CPL 0.2 mm surface	
				"60"- "90"	"100"- "110"
B117 FA	RAL 9003	door frame painted, edging painted	RAL 9003, edging painted or white	individual pricing depending on width, height and quantity of doors	
B068 FA	RAL 9016	door frame painted, edging painted or option LAMISTONE 258, white edging	RAL 9016, edging painted or white		
149 FA	RAL 7035	door frame painted, edging painted or option LAMISTONE 289, grey edging	RAL 7035/RAL 7047, edging painted		
G059 FA	RAL 7024	door frame painted, edging painted or LAMISTONE 531 option, anthracite edging	RAL 7024, edging painted		
N005 FA	RAL 9005	door frame painted, edging painted or option LAMISTONE 244, black edging	RAL 9005, edging painted or black edging		
G116 FA	RAL 7035 / RAL 7047	door frame painted, edging painted or option LAMISTONE 289, grey edging	RAL 7035/RAL 7047, edging painted		



STANDARD PARAMETERS OF POL-SKONE DOOR

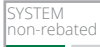

SYSTEM rebated	CLASS OF MECHANICAL STRENGTH			BURGLARY-RESISTANCE				FIRE RESISTANCE		SMOKE CONTROL	ACOUSTIC INSULATION				SPECIALISED		MECHANICAL DURABILITY			
																	20,000 cycles	50,000 cycles	100,000 cycles	200,000 cycles
	class 2	class 3	class 4	class RC2	class RC3	class RC4	class C	EI30	EI60	Sa, S ₂₀₀	27 dB	32 dB	37 dB	42 dB	climate class 3	RTG				

INTERIOR

PANEL TYPE	●	●	○	○	○	○	○	○	○	○	○	○	○	○	○	○	○	○	○	○	○
RAIL AND STILE TYPE	●	○	○	○	○	○	○	○	○	○	○	○	○	○	○	○	○	○	○	○	○
DECO INVEST SINGLE-LEAF DOOR	○	●	○	○	○	○	○	○	○	○	○	○	○	○	○	○	○	○	○	○	○
DECO INVEST DOUBLE-LEAF DOOR	●	○	○	○	○	○	○	○	○	○	○	○	○	○	○	○	○	○	○	○	○

INTERIOR ENTRANCE DOOR

HARMONY INVEST	○	●	●	○	○	○	○	○	○	○	○	○	○	○	○	○	○	○	○	○	○
HARMONY INVEST PRO	○	●	●	○	○	○	○	○	○	○	○	○	○	○	○	○	○	○	○	○	○
B-30	○	○	●	○	●	○	○	○	○	○	○	○	○	○	○	○	○	○	○	○	○
C-30	○	○	●	○	●	○	○	○	○	○	○	○	○	○	○	○	○	○	○	○	○
CERBER PLUS RC2	○	●	○	●	○	○	○	○	○	○	○	○	○	○	○	○	○	○	○	○	○
RC3, RC3 INVEST	○	○	●	○	●	○	○	○	○	○	○	○	○	○	○	○	○	○	○	○	○
RC4	○	○	●	○	○	●	○	○	○	○	○	○	○	○	○	○	○	○	○	○	○
RC4 EI30	○	○	●	○	○	●	○	○	○	○	○	○	○	○	○	○	○	○	○	○	○
CERBER PLUS	○	●	○	○	○	○	○	○	○	○	○	○	○	○	○	○	○	○	○	○	○
RC3 INVEST 37 dB	○	○	●	○	●	○	○	○	○	○	○	○	○	○	○	○	○	○	○	○	○

TECHNICAL

G46	●	○	○	○	○	○	○	○	○	○	○	○	○	○	○	○	○	○	○	○	○
FR EI30	○	●	○	○	○	○	○	○	○	○	○	○	○	○	○	○	○	○	○	○	○
FR EI30 SR	○	●	○	○	○	○	○	○	○	○	○	○	○	○	○	○	○	○	○	○	○
FR EI30 SR 42 dB	○	●	○	○	○	○	○	○	○	○	○	○	○	○	○	○	○	○	○	○	○
FR EI30 SR 42 dB DM	○	●	○	○	○	○	○	○	○	○	○	○	○	○	○	○	○	○	○	○	○
EI30 PLUS	○	●	○	○	○	○	○	○	○	○	○	○	○	○	○	○	○	○	○	○	○
EI60 PLUS	○	●	○	○	○	○	○	○	○	○	○	○	○	○	○	○	○	○	○	○	○
AKUSTIK SR 42 dB	○	○	●	○	○	○	○	○	○	○	○	○	○	○	○	○	○	○	○	○	○
SR 37 dB	○	○	●	○	○	○	○	○	○	○	○	○	○	○	○	○	○	○	○	○	○
TYPE A	●	○	○	○	○	○	○	○	○	○	○	○	○	○	○	○	○	○	○	○	○
TYPE B	●	○	○	○	○	○	○	○	○	○	○	○	○	○	○	○	○	○	○	○	○
TYPE A DUO	●	○	○	○	○	○	○	○	○	○	○	○	○	○	○	○	○	○	○	○	○
TYPE B DUO	●	○	○	○	○	○	○	○	○	○	○	○	○	○	○	○	○	○	○	○	○
HIGRO	●	○	○	○	○	○	○	○	○	○	○	○	○	○	○	○	○	○	○	○	○
GAMMA	○	●	○	○	○	○	○	○	○	○	○	○	○	○	○	○	○	○	○	○	○

* HARMONY INVEST PRO ODW

● available ○ unavailable ◐ optional

MOST COMMONLY USED FRAMES



ADJUSTABLE REBATED DOOR FRAMES

DIN SYSTEM

symbol	range [mm]	HIGH TOP			BLACK black, sage
		LAMISTONE CPL	PAINTED white	PAINTED grey, beige	
		SILKSTONE			
		UNI MAT PLUS			
ZP2	95-120				
ZP3	120-140				
ZP4	140-160				

SUGGESTED INSTALLATION HOLES	WIDTH		HEIGHT
	type	So	Ho
	"70"	776	2053
	"80"	876	

Tolerance of dimensions ±1 mm
So - installation opening width
Ho - installation opening height

AQUA DIN

symbol	range [mm]	HIGH TOP			BLACK black, sage
		LAMISTONE CPL	PAINTED white	PAINTED grey, beige	
		SILKSTONE			
		UNI MAT PLUS			
ZP2	95-120				
ZP3	120-140				
ZP4	140-160				

SUGGESTED INSTALLATION HOLES	WIDTH		HEIGHT
	type	So	Ho
	"70"	776	2053
	"80"	876	

Tolerance of dimensions ±1 mm
So - installation opening width
Ho - installation opening height



ADJUSTABLE NON-REBATED DOOR FRAMES

DIN DUO SYSTEM

symbol	range [mm]	HIGH TOP			BLACK black, sage
		LAMISTONE CPL	PAINTED white	PAINTED grey, beige	
		SILKSTONE			
		UNI MAT PLUS			
ZD4	95-120				
ZD5	120-140				
ZD6	140-160				

SUGGESTED INSTALLATION HOLES	WIDTH		HEIGHT
	type	So	Ho
	"70"	790	2075
	"80"	890	

Tolerance of dimensions ±1 mm
So - installation opening width
Ho - installation opening height

AQUA DIN DUO

symbol	range [mm]	HIGH TOP			BLACK black, sage
		LAMISTONE CPL	PAINTED white	PAINTED grey, beige	
		SILKSTONE			
		UNI MAT PLUS			
ZD4	95-120				
ZD5	120-140				
ZD6	140-160				

SUGGESTED INSTALLATION HOLES	WIDTH		HEIGHT
	type	So	Ho
	"70"	790	2075
	"80"	890	

Tolerance of dimensions ±1 mm
So - installation opening width
Ho - installation opening height

full range of rebated and non-rebated door frames available on pages 210-231



HIDDEN DOOR FRAMES

HARMONY POL-SKONE SYSTEM

door leaf dimensions and number of hinges	for do-it-yourself painting (raw aluminium)	anodised aluminium	PAINTED white, grey, beige white hinges			BLACK black, sage black hinges		
			SUGGESTED INSTALLATION HOLES	WIDTH			HEIGHT	
			type	So	Sd*	Sd**	Ho	Hd
"60"- "80" x 2040 / 2050 mm (2 hidden hinges)			"70"	810	793	796	2090*	2082*
"90"- "100" x 2040 / 2050 mm (3 hidden hinges)			"80"	910	893	896	2100**	2092**
"60"- "100" x 2140 / 2150 mm (3 hidden hinges)								
"60"- "100" x 2240 / 2250 mm (3 hidden hinges)								
"60"- "100" x 2340 / 2350 mm (4 hidden hinges)								
"60"- "100" x 2440 / 2450 mm (4 hidden hinges)								

* outward opening door ** inward opening door;

Tolerance of dimensions ±1 mm
Sd - door width on the door frame external side
So - installation opening width
Hd - door height on the external side of the door frame
Ho - installation opening height

Full range of hidden door frames available on page 11

PRODUCT CATALOGUES



WOODEN
-WOODEN
WINDOWS
ALUMINIUM



STOLARKA ZEWNĘTRZNA



PRODUCTS
WITH A MAXIMUM
10-DAY
DELIVERY TERM



EXTERIOR
DOORS



**IF YOU HAVE ANY INQUIRIES,
DO NOT HESITATE TO CONTACT
OUR SALES DEPARTMENT**

Export Department - RU, EN
tel. +48 663 810 020
export.en@pol-skone.eu

Export Department - RU, DE
tel. +48 663 810 073
export3@pol-skone.eu

POL-SKONE Sp. z o.o.
ul. Hanki Ordonówny 8; 20-328 Lublin, POLAND
tel.: +48 81 728 52 85; +48 81 744 30 11-13
fax: +48 81 744 24 89; +48 81 744 39 12
e-mail: pol-skone@pol-skone.eu

This Product Catalogue is valid as of 01.01.2024 (as of this date, previous POL-SKONE catalogues are no longer valid). The present publication does not constitute a commercial offer as defined under applicable laws and is provided for informative purposes only. The manufacturer reserves right to introduce modifications.